

OPERATING AND CALIBRATION MANUAL

HP 3784A

DIGITAL TRANSMISSION ANALYZER

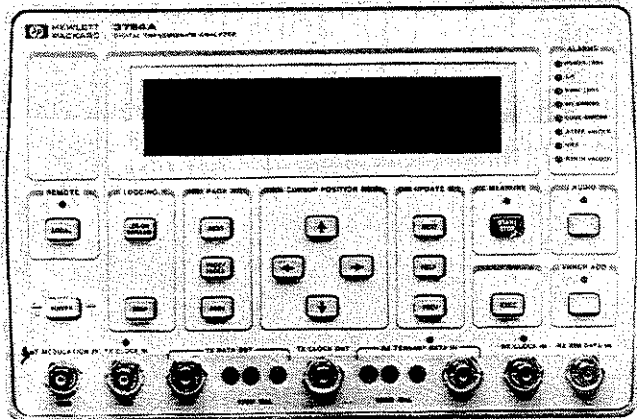

CERTIFICATION

Hewlett-Packard Company certifies that this product met its published specifications at the time of shipment from the factory. Hewlett-Packard further certifies that its calibration measurements are traceable to the United States National Bureau of Standards, to the extent allowed by the Bureau's calibration facility and to the calibration facilities of other International Standards Organization members.

WARRANTY

This Hewlett-Packard product is warranted against defects in materials and workmanship for a period of one year from date of shipment. During the warranty period, Hewlett-Packard Company will, at its option, either repair or replace products which prove to be defective.

For warranty service or repair, this product must be returned to a service facility designated by HP. Buyer shall prepay shipping charges to HP and HP shall pay shipping charges to return the product to Buyer. However, Buyer shall pay all shipping charges, duties, and taxes for products returned to HP from another country.

HP warrants that its software and firmware designated by HP for use with an instrument will execute its programming instructions when properly installed on that instrument. HP does not warrant that the operation of the instrument, or software, or firmware will be uninterrupted or error free.

LIMITATION OF WARRANTY

The foregoing warranty shall not apply to defects resulting from improper or inadequate maintenance by Buyer. Buyer-supplied software or interfacing, unauthorized modification or misuse, operation outside of the environment specifications for the products, or improper site preparation or maintenance.

NO OTHER WARRANTY IS EXPRESSED OR IMPLIED. HP SPECIFICALLY DISCLAIMS THE IMPLIED WARRANTIES OF MERCHANTABILITY AND FITNESS FOR A PARTICULAR PURPOSE.

EXCLUSIVE REMEDIES

THE REMEDIES PROVIDED HEREIN ARE BUYER'S SOLE AND EXCLUSIVE REMEDIES. HP SHALL NOT BE LIABLE FOR ANY DIRECT, INDIRECT, SPECIAL INCIDENTAL, OR CONSEQUENTIAL DAMAGES, WHETHER BASED ON CONTRACT, TORT, OR ANY OTHER LEGAL THEORY.

ASSISTANCE

Product maintenance agreements and other customer assistance agreements are available for Hewlett-Packard products.

For any assistance, contact your Hewlett-Packard Sales and Service Office. Addresses are provided at the back of this manual.

OPERATING AND CALIBRATION MANUAL

HP 3784A
DIGITAL TRANSMISSION ANALYZER

SERIAL NUMBERS

This manual applies directly to instruments with serial numbers prefixed 2902U.

For additional important information about serial numbers, see **INSTRUMENTS COVERED BY MANUAL** in Section 6.

© Copyright HEWLETT-PACKARD LIMITED 1989
SOUTH QUEENSFERRY, WEST LOTHIAN, SCOTLAND

WARNING

READ THE FOLLOWING NOTES BEFORE INSTALLING OR SERVICING ANY INSTRUMENT.

1. IF THIS INSTRUMENT IS TO BE ENERGISED VIA AN AUTO-TRANSFORMER MAKE SURE THAT THE COMMON TERMINAL OF THE AUTO-TRANSFORMER IS CONNECTED TO THE NEUTRAL POLE OF THE POWER SOURCE.
2. THE INSTRUMENT MUST ONLY BE USED WITH THE MAINS CABLE PROVIDED. IF THIS IS NOT SUITABLE, CONTACT YOUR NEAREST HP SERVICE OFFICE. THE MAINS PLUG SHALL ONLY BE INSERTED IN A SOCKET OUTLET PROVIDED WITH A PROTECTIVE EARTH CONTACT. THE PROTECTIVE ACTION MUST NOT BE NEGATED BY THE USE OF AN EXTENSION CORD (POWER CABLE) WITHOUT A PROTECTIVE CONDUCTOR (GROUNDING).
3. BEFORE SWITCHING ON THIS INSTRUMENT:
 - (a) Make sure the instrument input voltage selector is set to the voltage of the power source.
 - (b) Ensure that all devices connected to this instrument are connected to the protective (earth) ground.
 - (c) Ensure that the line power (mains) plug is connected to a three-conductor line power outlet that has a protective (earth) ground. (Grounding one conductor of a two-conductor outlet is not sufficient).
 - (d) Check correct type and rating of the instrument fuse(s).

How To Use This Manual

This manual contains all the necessary information to enable you to switch-on and confidently operate the HP 3784A Digital Transmission Analyzer. It does not cover Remote Operation, which is described in a separate manual titled "Remote Operation" (part number 03784-90001).

There are eight self-contained sections giving information on initial switch-on, detailed measurements, Data Logging, a reference section on each of the Pages displayed, General Information, Installation and full Performance Tests.

If you are new to the HP 3784A and unfamiliar with its operating concept, you may wish to read Section 2 Getting Started, and key in the examples shown. It won't take long to become familiar with the instrument and its many features.

The following paragraphs describe each of the sections and appendices in this Operating and Calibration manual. Read through these paragraphs to acquaint yourself with the organisation of the manual prior to using your new HP 3784A.

Section 1: Introduction to the HP 3784A Digital Transmission Analyzer

The Introduction to the HP 3784A Digital Transmission Analyzer section gives a brief explanation of the use, applications and features of the HP 3784A.

Section 2: Getting Started

The Getting Started section is designed to help the first time user. This section describes how to turn on the instrument, make your first measurement, use the keyboard to select an Index or Page and control the Cursor. All front and rear panel controls, connectors and indicators are explained, and a list of Self Test features given.

Section 3: Making Measurements

The Making Measurements section describes the use of the HP 3784A in making typical measurements on both in-service and out-of-service systems. These measurements were selected as examples to cover topics of general interest in a manner that demonstrates the capabilities of the HP 3784A.

Section 4: Page Function Description

This section is intended to be used as a reference section, as it lists all the user selectable functions/parameters within each information page. An information page is the page displayed and selected from one of the two index pages. Refer to this section if you need to know the choices offered on any particular page.

Section 5: Data Logging

The **Data Logging** section provides information on how to log measurement results to an external Printer via HP-IB or RS-232-C.

This includes advice on Recommended Printers, Applications, connecting the HP 3784A to a Printer, configuring the Printer, a "Quick Guide to Data Logging", practical examples of how to log Bit Error measurement results numerically, and Code Error results graphically and detailed explanations of how to log results in "Real Time" and as an "End of Period Summary". Use the "Quick Guide to Data logging" if you are familiar with the HP 3784A, and can confidently use the keyboard to select pages etc.

Section 6: General Information

The **General Information** section gives a list of safety considerations, specifications and instruments covered by the manual.

Section 7: Installation

The **Installation** section contains information and instructions required to prepare the HP 3784A for use. Included in this section are the initial inspection procedures, power and grounding requirements, fuse selection procedures, instructions on repackaging for shipment, and installation information for both HP-IB and RS-232-C.

Section 8: Performance Tests

The **Performance Tests** section contains procedures which test the instrument electrical performance using the specifications listed in Section 6.

Appendices

There are six appendices, the titles of which are self explanatory, they are as follows:

- Appendix A: Measurement Definitions
- Appendix B: Glossary of Terms
- Appendix C: Operating Notes
- Appendix D: Operator Selectable Switches in the HP 3784A
- Appendix E: Panel Memory Record Sheet
- Appendix F: Error Codes

Contents

Chapter 1	Page
Introduction to the HP 3784A Digital Transmission Analyzer	1-1
Description	1-1
Chapter 2	Page
Getting Started	2-1
Introduction	2-1
Instrument Turn On	2-1
Procedure.....	2-1
Operating The HP 3784A.....	2-3
HP 3784A Display At Switch-On.....	2-3
Making your first Measurement.....	2-3
Selecting An Index Or Page.....	2-8
PAGE Keys.....	2-8
Controlling The Cursor.....	2-9
Changing User Selectable Functions/Parameters	2-10
Front Panel Operating Features	2-11
Front Panel Input/Output Ports.....	2-13
Alarms.....	2-15
Rear Panel Input/Output Ports.....	2-16
Self Test Features.....	2-18
Option Instruments.....	2-18
Default Settings.....	2-18
Chapter 3	Page
Making Measurements with the HP 3784A	3-1
Introduction	3-1
What Measurements does the HP 3784A perform?	3-1
Error Measurements.....	3-1
Error Analysis Measurements.....	3-2
Alarm Duration Measurements.....	3-2
Slip Measurement.....	3-3
Jitter Measurements (Option 002 instruments).....	3-3
64 kbit/sec Codirectional Interfaces (Option 006).....	3-3
Making a Measurement.....	3-4
Transmitter Setup.....	3-4
Receiver Setup.....	3-4
Gating	3-4

Contents (continued)

Measurements and Results.....	3-5
Storing Measurement Configuration.....	3-5
Receiver Auto-Configure.....	3-5
Making Out-of-Service Error Measurements.....	3-7
Bit Error Measurement on Coded Ternary Data.....	3-7
Code Error Injection and Measurement.....	3-8
Bit Error Ratio Measurement at Binary TTL Interfaces.....	3-9
Bit Error Count Measurement at Binary TTL Interfaces.....	3-10
Making In-Service Code Error Measurements.....	3-12
In-Service Measurements.....	3-12
Code Error Measurement on Live Traffic - In-service.....	3-12
Monitor Mode.....	3-12
Error Analysis Measurements.....	3-14
Analysis PASS/FAIL Thresholds.....	3-14
Error Analysis Example.....	3-15
Additional Measurements.....	3-16
Using Zerosubstitution.....	3-16
Frequency Measurement.....	3-17
Frequency Offset Measurements.....	3-17
AIS Pattern Generation and Detection.....	3-18
Storing and Recalling Measurement Configurations.....	3-19
To Store Configuration in Preset Panel.....	3-19
To Recall Set-up from Panel Memory.....	3-19
Jitter Measurements - Option 002.....	3-20
Practical Jitter Measurements.....	3-20
Jitter Transfer Function.....	3-21
Jitter Tolerance Measurement.....	3-21
HP 3784A Jitter Generation and Measurements.....	3-22
Jitter Generation.....	3-22
THRU DATA Mode.....	3-22
Transmitter Jitter Modulation.....	3-23
Internal Modulation.....	3-23
Swept and Spot Mask Modulation.....	3-23
External Modulation.....	3-24
Jitter Measurement.....	3-25
Measurement Filters.....	3-25
Intrinsic Jitter Performance.....	3-25
Jitter Measurement Display Update Rates.....	3-25
Jitter Measurements on a Binary Clock Signal.....	3-26
HP 3784A Output Jitter Measurement.....	3-27
In-Service Output Jitter Measurements.....	3-28
Jitter Analysis Measurement.....	3-28
HP 3784A Jitter Tolerance Measurements.....	3-29
Jitter Tolerance Measurement at a Number of Jitter Points.....	3-29
Jitter Tolerance Measurement using "Spots" on Jit. Mask.....	3-29
Jitter Tolerance Measurement using Swept Mask Modulation.....	3-29
Automatic Jitter Tolerance Plotting.....	3-29
How to Make a Jitter Tolerance Measurement.....	3-30

How to Make an Automatic Jitter Tolerance Measurement	3-32
HP 3784A Jitter Transfer Function Measurement	3-34
How To Make A Jitter Transfer Function Measurement	3-34
How to Make an Automatic Transfer Function Measurement.....	3-35
Alternate Word Pattern Generation.....	3-36
HP 3784A OPT 006 - 64 kbit/s Measurements.....	3-37
Practical Measurements at 64 kbit/s Codirectional Interfaces.....	3-38
Plesiochronous Timing	3-38
Synchronous Timing - Looped	3-39
Synchronous Timing - External Clock.....	3-40

Chapter 4	Page
Page Function Description	4-1

Introduction	4-1
Store and Recall Measurement Configurations (Page 1).....	4-1
Tx Setup (Page 2).....	4-4
Rx Setup (Page 3).....	4-7
Measurements (Page 4)	4-10
How to Control Measurement Gating (Page 5).....	4-13
Alarms (Page 6).....	4-15
Data Logging (Page 7).....	4-16
Remote Control (Page 8)	4-22
Logging Port (Page 9).....	4-28
Rear Panel Ports (Page 10)	4-29
Real Time Clock and Calendar (Page 11).....	4-31
Self-test (Page 12).....	4-32

Chapter 5	Page
Data Logging	5-1

Introduction	5-1
Recommended Printers	5-1
Applications of Data Logging	5-1
Connecting the HP 3784A to a Printer.....	5-2
Quick Guide to Data Logging with the HP 3784A.....	5-5
Logging Bit Error Measurement Results.....	5-7
Graphics Mode	5-10
Log Code Error Results Graphically	5-13
Results Printed in Real Time	5-15
Counts/Second	5-15
Page 4 Results Explained	5-16
End of Period Results Summary Explained	5-17
What Triggers Logging?	5-20

Contents (continued)

Log On Demand.....	5-22
What Stops Logging?	5-23
Squelch	5-23
External Triggering (option 002 only)	5-24

Chapter 6	Page
General Information	6-1
Introduction	6-1
Specifications	6-1
Safety Considerations	6-1
Instruments Covered By Manual	6-2

Chapter 7	Page
Installation	7-1
Introduction	7-1
Initial Inspection	7-1
Contents	7-1
Preparation For Use	7-2
Power Requirements	7-2
Line Voltage Selection	7-2
Power Cable	7-2
HP 3784A Display Contrast Adjustment	7-3
Internal Battery	7-3
Battery Failure	7-3
Operating Environment	7-4
Storage and Shipment	7-4
Environment	7-4
Rack Mounting	7-5
Packaging	7-7
Hewlett-Packard Interface Bus (HP-IB) Installation	7-8
Connection To The HP-IB	7-8
HP-IB Cables	7-9
RS-232-C Interface Installation	7-10
Connection to the RS-232-C System	7-10
Logic Levels	7-10
RS-232-C Remote Control	7-10

Chapter 8	Page
Performance Tests	8-1
Introduction	8-1
Equipment Required.....	8-1
Test Record.....	8-2
Calibration Cycle.....	8-2
Performance Test Contents.....	8-2
Operation Verification	8-2
Self Tests.....	8-2
Instrument Default Settings.....	8-2
External Clock.....	8-3
Internal Clock and Frequency Offset.....	8-5
Binary Clock and Data Outputs	8-8
Transmitter n-Bit Programmable Word.....	8-10
Transmitter Pattern Trigger	8-12
Transmitter PRBS Pattern Verification.....	8-14
Transmitter Alternating Word.....	8-16
Ternary Data Outputs	8-18
Bit and Code Error Add.....	8-22
Receiver Binary Data and Clock	8-24
Receiver Clock Recovery.....	8-26
Ternary Data Input Levels.....	8-28
Reference WORD and Synchronization.....	8-30
Receiver Reference PRBS Patterns and Zero Substitution	8-31
Receiver Autoconfigure and AIS Indication	8-34
Measurement Gating and Power Loss Alarm.....	8-36
Error Out.....	8-37
Receiver Error Detection and Measurement	8-39
HP-IB Verification.....	8-41
External Modulation Input (Option 002)	8-42
Int Mod and Demod Jitter Measurement In (Opt 002)	8-50
Performing Jitter Self Tests (Option 002).....	8-55
Thrudata (Option 002).....	8-57
64 kbit/s Co-directional Interface (Option 006)	8-60

Appendix A	Page
Measurement Definitions	A-1
Introduction	A-1
Measurements.....	A-1
Error Measurements.....	A-1
Error Count.....	A-1
Error Ratio.....	A-1
Error Intervals.....	A-1
Error Free Intervals.....	A-2

Contents (continued)

Error Analysis:	A-2
Availability*	A-2
Unavailability:	A-2
Error Seconds*	A-3
% Severely Errored Seconds*	A-3
Degraded Minutes*	A-3
Error Distribution:	A-3
Error Bursts:	A-3
Long Term Mean Error Ratio:	A-4
GO/NO GO Tests:	A-4
Loss Measurements:	A-4
Power Loss	A-4
AIS:	A-4
Sync. Loss:	A-5
Data Loss: (Ternary Mode)	A-5
Rx Clock Loss: (Binary & Thru data only)	A-5
Tx Clock Loss:	A-5
Slip Count	A-5
Frequency and Offset:	A-6
Offset Measurement Range:	A-6
Offset Measurement Resolution:	A-6
Frequency Measurement Resolution:	A-6
Accuracy: (Binary or Ternary):	A-6
Options	A-6
Option 002:	A-6
Automatic Tolerance Plotting:	A-6
Automatic Jitter Transfer Function Plotting:	A-7
Standard Tolerance Masks:	A-7
Programmable Tolerance Masks:	A-8
Receiver Display Rates:	A-8
Internal Filtering:	A-8
Max. Peak-Peak:	A-8
Hit Count:	A-9
Sensitivity:	A-9
Threshold Range:	A-9
Hit Intervals:	A-9
Hit Free Intervals:	A-9
Measurement In:	A-9
Warning/Indicator Lamps:	A-9
Jitter Unlock	A-9
Hits	A-10
Bounds Indicators	A-10

Appendix B	Page
Glossary Of Terms	B-1

Appendix C	Page
Operating Notes	C-1

Introduction	C-1
Selecting Jitter Measurements	C-1
Selecting Thrudata	C-1
Selecting Codirectional Interface	C-1
Monitor Code Errors Alarm Led	C-1
Measuring Received Jitter in Thrudata Mode	C-2
Interface Choices	C-2
Tx Jitter Amplitude p-p (option 002)	C-2
Optimum Jitter Intrinsic Performance	C-2
Avoiding Timing Problems	C-2
Selecting Jitter Masks	C-2
RX REF CLOCK IN	C-3

Appendix D	Page
Operator Selectable Switches In The HP 3784A	D-1

Appendix E	Page
Panel Memory Record Sheet	E-1

Introduction	E-1
--------------------	-----

Appendix F	Page
Error Codes	F-1

Introduction	F-1
CPU Selftest	F-1
RS-232 Modem Port Selftest	F-1
RS-232 Printer Port Selftest	F-1
Clock Synthesiser Selftest	F-1
Jitter Selftest	F-2
BER Self Test	F-2
Table of Error Codes	F-2

Introduction to the HP 3784A Digital Transmission Analyzer

1

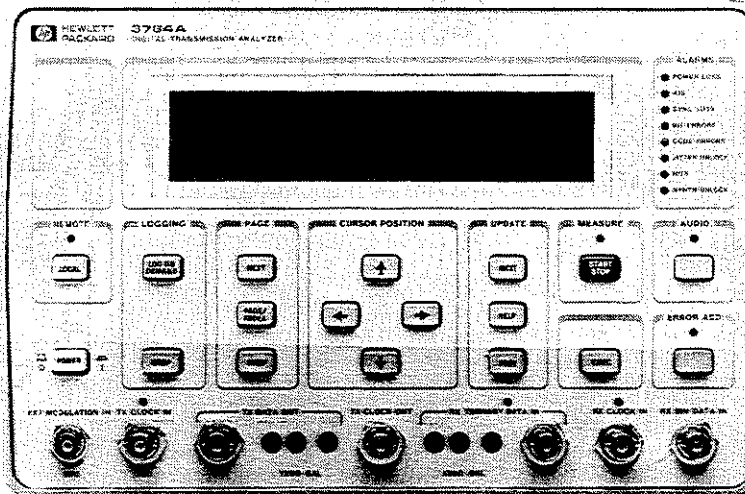

Figure 1-2 HP 3784A Digital Transmission Analyzer

Description

The HP 3784A Digital Transmission Analyzer is a self-contained, multi-rate, bit error rate test set. Applications include the development, manufacturing test, installation and troubleshooting of digital transmission terminal and link equipment, operating at line rates in the range 1kb/s to 50Mb/s.

The instrument comprises a generator and a receiver and has been designed to conform to CCITT and CEPT standards at the 704, 2048, 8448 and 34368kb/s hierarchical interfaces. The generator provides data patterns at the appropriate levels, format and impedance, required by the equipment under test. The receiver monitors the received data patterns for bit and code errors, at any one of the four CEPT rates, or for bit errors in the range 1kb/s to 50Mb/s when using binary interfaces. For bit error measurements, the HP 3784A also performs Error Analysis measurements based on CCITT G.821 Recommendation.

Option 002 provides timing jitter generation, measurement and analysis at 2048, 8448 and 34368kb/s. Jitter tolerance, jitter transfer function and output jitter measurements can be made in accordance with CCITT Recommendations. Swept frequency measurements, e.g. tolerance and transfer function can be performed automatically.

Option 006 is a 64kb/s codirectional interface which provides transmission and reception of binary or ternary coded 64kb/s data. This allows bit error measurement (no code error detection is provided) at the lowest digital data rate. Note: options 002 and 006 are mutually exclusive.

A Thru-data mode permits the injection of timing jitter when Option 002 is fitted, on to a signal passing through the instrument. This facility allows the testing of alarms, error correction schemes and automatic protection switches.

The HP 3784A is microprocessor controlled and may be remotely controlled, either via the HP-IB or RS-232C Interfaces. (HP-IB - Hewlett-Packard Interface Bus - is Hewlett-Packard's implementation of IEEE Standard 488-1978.) Data can be logged, either in numeric or graphics form, to an external printer via either HP-IB or RS-232C.

Introduction

The purpose of this section is to instruct first time users how to turn on the HP 3784A and quickly become proficient operating the instrument. The section covers the following items:-

Instrument Turn On - Step by step instructions on how to configure and safely connect the HP 3784A to the power line.

Operating The HP 3784A - Simple instructions on how to operate the HP 3784A using the front panel keyboard.

Front and Rear Panel Operating Features - Detailed descriptions of all the front and rear panel keys, connectors and lamps (leds and display).

Self Test - An explanation of the self test features of the HP 3784A.

Instrument Turn On

CAUTION

Do not turn on the HP 3784A until it has been configured and fused for the available line voltage and safely connected to the power line.

Procedure

1. Set the rear panel Voltage Selector switch to the position that corresponds to the power line voltage to be used (115V or 230V).
2. Verify that the proper fuse is installed in the rear panel fuse holder. See Table 2-1.

Table 2-1. Fuses

Voltage Selector	Fuse Type	HP Part Number
115V	3A	2110-0381
230V	1.5A	2110-0304

3. Ensure the front panel **POWER** switch is set to OFF.
4. Connect the ac power cord to the rear panel Line Input connector. Plug the other end of the power cord into a three terminal grounded power outlet.
5. Set the instrument **POWER** switch to ON. Verify that the following events occur at switch-on.
 - The audible alarm beeps twice.
 - All front panel leds illuminate simultaneously for approximately 1 second.
 - The display backlight illuminates and a complete set of characters is displayed momentarily.
 - After initial switch on the HP 3784A display will be an "Index" or a "Page" of information. The display is dependent on the last configuration prior to a power down. It can be either 1 of 2 Indexes or 1 of 12 information Pages.

Operating The HP 3784A

The HP 3784A is controlled by means of a Liquid Crystal Display (LCD) and a simple keyboard. Information on instrument status, configuration and results etc, is displayed to the operator in Pages of information which may be accessed for viewing or change via the keyboard. The information Pages are organized into an Index which lists all the Pages in numerical order, indicating the information content of each page. There are 2 Indexes and 12 information Pages. The 2 Indexes listing all the Pages are as follows:

Index 1 (Need help ? Push the HELP key)	
Preset Panel..... 1	Measurements..... 4
Tx Set-Up..... 2	Gating Period.... 5
Rx Set-Up..... 3	Alarm Durations.. 6

Index 2 (Need help ? Push the HELP key)	
Data Logging..... 7	Rear Panel Ports 10
Remote Cont Port. 8	Time/Date Set... 11
Logging Port..... 9	Option/Self Test 12

A simple "cursor" system used in conjunction with the PAGE and UPDATE keys allows access for viewing the Pages and Indexes, and also selection of the various functions/parameters within each page.

HP 3784A Display At Switch-On

At switch on, the display presented is dependent on the last configuration prior to a power down. The built-in nonvolatile memory stores the current HP 3784A settings and recalls them when the instrument is powered up again.

Making your first Measurement

The following procedure leads you through setting the HP 3784A to its default settings, and performing a simple Bit Error Rate measurement. Detailed explanations of how to use the HP 3784A keyboard, and the function of each input/output port are given later in this section.

Powering Up

1. Set the instrument **POWER** switch to ON. Verify that the following events occur at switch-on.
 - The audible alarm beeps twice.
 - All front panel leds illuminate simultaneously for approximately 1 second.
 - The display backlight illuminates and a complete set of characters is displayed momentarily.
 - After initial switch on the HP 3784A display will be an "Index" or a "Page" of information. The display is dependent on the last configuration prior to a power down. It can be either 1 of 2 Indexes or 1 of 12 information Pages.

Finding the Index Page

2. Is an Index page displayed? NO.....Press the **PAGE/INDEX** key.
YES.....continue to step 3.
3. Is Index 1 displayed? NO.....Press the PAGE **PREV** key.
YES.....continue to step 4.

Is the HP 3784A Gating?

4. It may be that during the last power-down the HP 3784A was making a measurement. If this was the case, then when you switch the HP 3784A ON, the instrument will continue with the measurement (indicated by the MEASURE and POWER LOSS LED's being ON). If the MEASURE LED is ON, press the **START/STOP** key to stop the HP 3784A gating.

Setting Instrument Default State

5. Position the flashing cursor (flashing black square) on Preset Panel...1 using the CURSOR POSITION keys.

```

Index 1 (Need help ? Push the HELP key)
Preset Panel..... 1 Measurements..... 4
Tx Set-Up..... 2 Gating Period.... 5
Rx Set-Up..... 3 Alarm Durations.. 6
    
```

6. Press the **PAGE/INDEX** key to display Page 1.
If your instrument is a standard HP 3784A, Page 1 Preset Panel will be displayed. If your instrument includes option 002 (Jitter Generation/ Measurement) the Page displayed may be one of Preset [PANEL] or Preset [MASK]. Ignore all other user selectable fields within each page for the present.

Note: User selectable fields are shown enclosed in brackets thus, [**]. An example of Page 1 Preset [PANEL] and Page 1 Preset [MASK] is given below:

```

1 Preset [PANEL]
Function [RECALL FROM] Panel Memory [0]
Select desired function & press EXEC.
Keyboard lock [OFF]
    
```

```

1 Preset [MASK] [STD ] 2MHz      Points 4
20.0Hz  1.50 UI ▶ 93.0Hz  1.50 UI
700.Hz  0.20 UI ▶ 100.KHz  0.20UI
Q Factor [HIGH]
    
```

7. If Page 1 Preset [MASK] is displayed press the UPDATE key to select Page 1 Preset [PANEL].
8. Ensure the Keyboard Lock is set to [OFF]. If it is not, position the flashing cursor on Keyboard lock and press the UPDATE key.
9. Set the Function to [RECALL FROM] using the CURSOR POSITION and UPDATE keys.
10. Position the flashing cursor on the Panel Memory and using the UPDATE key select Panel Memory [0].
11. The HP 3784A display should now be identical to the one given below.

```
1 Preset [PANEL]
Function [RECALL FROM] Panel Memory [0]
Select desired function & press EXEC.
Keyboard lock [OFF]
```

12. Press the key to set the 3784A to its default settings.

The HP 3784A is now set to its default settings; these are listed on page 2-20. It is recommended to set the instrument to its default condition before configuring a measurement, as one starts from a known set condition.

Making a Bit Error Count Measurement

Introduction

The following steps lead you through configuring the HP 3784A Transmitter and Receiver to make a Bit Error Count measurement over a manually controlled gating period. The Transmitter is set to enable errors to be added to the output data via the front panel ERROR key.

13. Connect the HP 3784A as shown in the following diagram.

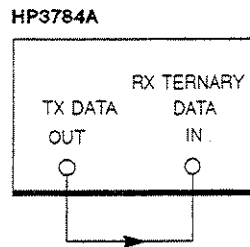

14. Select Page 2 Tx Setup.....use the PAGE key.
Set the display to the following.....use the CURSOR POSITION and UPDATE keys.
Note: When Er Add [BIT] [MAN.] is selected the ERROR ADD LED on the front panel illuminates.

```
2 Tx Setup.   Data Out [ 75 TERM] [HDB3]
Clock [STD RATE] [34 MHz] Offset [ +0] ppm
Pattern [PRBS] - [23]       Zero Sub [000]
Er Add [BIT ] [MAN.]       Clock Out [NORM]
```

15. Select and display Page 3 Rx Setup.....use the PAGE key.

16. Check the display is set to the following:

```
3 Rx Setup   [AS TX ]

Jitter Display Rate [FAST]
```

17. Select Page 5 Gating Period.....use the PAGE key.
Set the display to the following.....use the UPDATE and CURSOR POSITION keys.

```
5 Gating Period.
Gating type [MANUAL]

Errored/Error free intervals [SECONDS ]
```

19. Select Page 4.....use the PAGE PREV key.
Set Page 4 to [ERROR RESULTS].....use the UPDATE NEXT key.
20. Press the MEASURE START/STOP key to initiate the measurement.
The green LED above the START/STOP key is illuminated during the measurement period.
21. Inject errors into the Transmitter output data using the front panel ERROR ADD key. Each key press will inject a single error into the received data. Observe that the ERROR LED illuminates, and the Bit Error Count result increments with each key press.

```

4 [ ERROR RESULTS ] (Tx Jitter On)
Elapsed time..... 00d 00h 00m 00s
Rx [CODE ERR.] [COUNT ].....
Rx Bit Error [COUNT ].....

```

Note: The number of times you press the ERROR ADD key determines the Bit Error Count result.

22. Press the MEASURE START/STOP key to stop the HP 3784A gating.

What have you learnt from this Procedure?

You should now understand:

- a. The sequence of events at power-on.
- b. How to select an Index or Information Page.
- c. Setting the HP 3784A to its default settings.
- d. How to make a Bit Error Count measurement.

What's Next?

The following paragraphs explain in detail the operation and function of all front and rear panel controls, connectors and indicators.

For more information on how to perform a measurement and the measurements available, refer to the "Making Measurements" section.

Selecting An Index Or Page

The example below illustrates the key action to select a Page from the Index and then return to the Index.

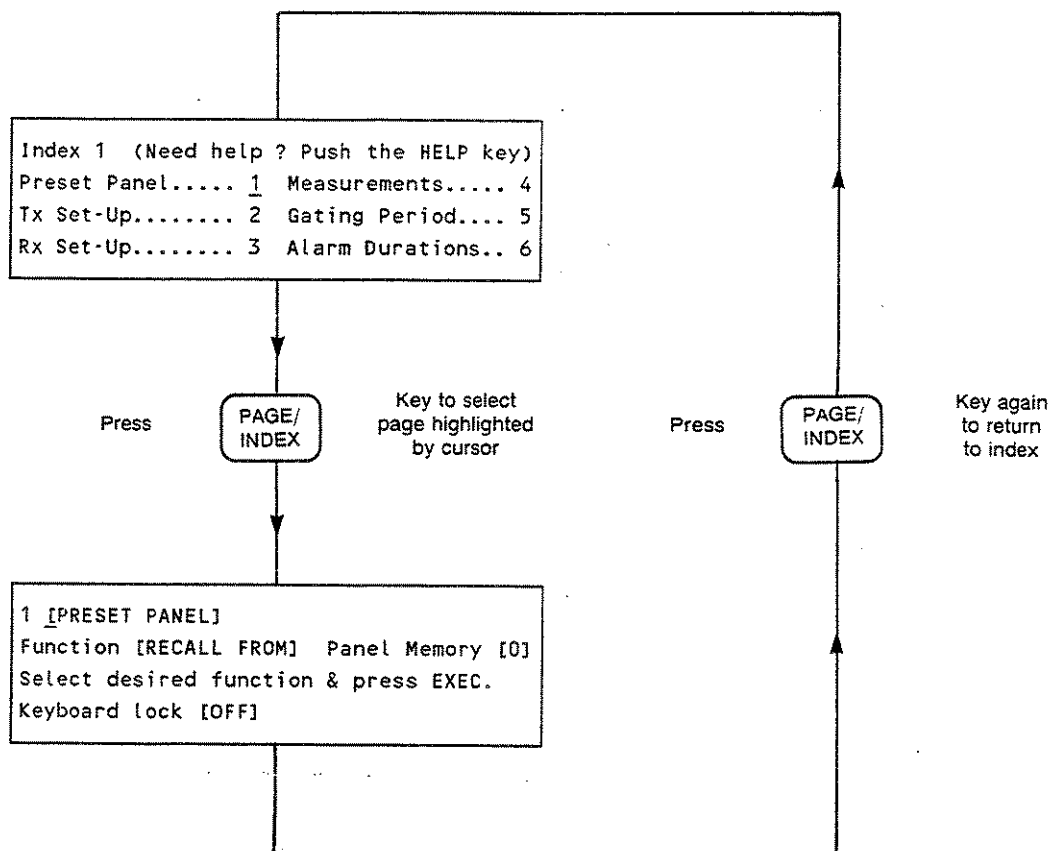

PAGE Keys

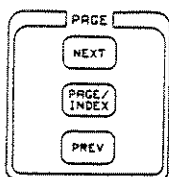

To Select An Index - If, when you switch on, an Index is displayed then use the PAGE **PREV** and **NEXT** keys to step between the two Indexes. If an information Page is displayed, then press the **PAGE/INDEX** key to display the Index.

Repeated pressing of the **PAGE/INDEX** key will alternate the display between the Index, and the page on the Index list which is highlighted by the flashing cursor (flashing back square).

To Select A Page - If a Page is already displayed then use the PAGE **PREV** and **NEXT** keys to step backwards and forwards through the Pages. Alternatively, press the **PAGE/INDEX** key to display an Index then using the CURSOR POSITION keys, move the flashing cursor to the page number you require and press the **PAGE/INDEX** key.

When an Index is displayed simply use the CURSOR POSITION and **PAGE/INDEX** keys to display the required Page.

The following example illustrates the PAGE **NEXT** and **PREV** operation when Page 6 is currently displayed.

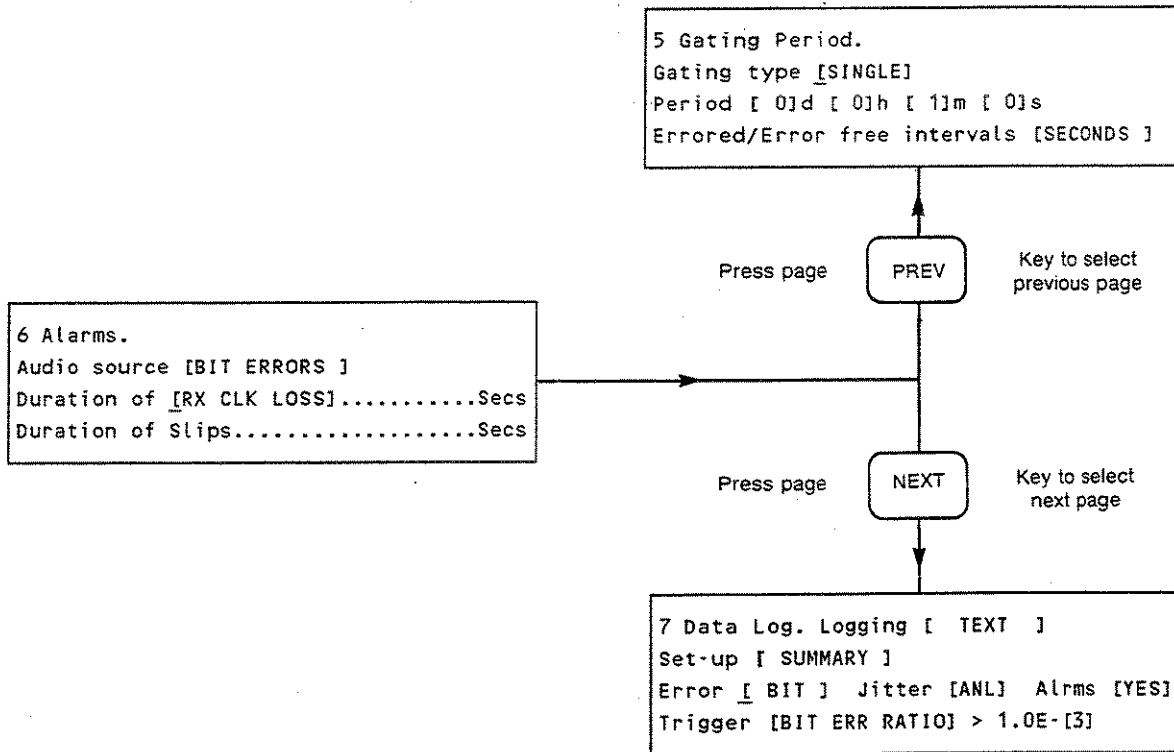

Controlling The Cursor

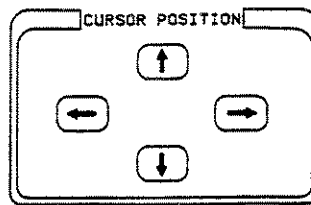

These four keys, each marked with an appropriate direction - indicating arrow, enable the user to position the cursor on an appropriate display field, for example a page number in the Index or a measurement parameter on a page.

Changing User Selectable Functions/Parameters

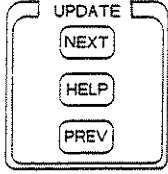

All the selectable fields are enclosed in square brackets [-]. To change a parameter, position the cursor on the relevant display field and use the UPDATE and keys to step through the various choices available.

Where the field selections are descriptive (ie functional) the field is effectively a continuous loop. The UPDATE key steps through the selections in one direction, while the UPDATE key steps through in the opposite direction.

When the choices are numeric the UPDATE key increases the parameter to the next available value, while UPDATE decreases the parameter value. The numeric fields have end stops at minimum and maximum values; indicated by an audible beep.

The UPDATE keys are inoperative when an Index is displayed.

The following example illustrates how the CURSOR POSITION and UPDATE keys control the selection of functions/parameters within each display field.

Note: Only relevant choices are presented to the user. For example, on Page 5, the Period field is only shown when either REPEAT or SINGLE gating is selected.

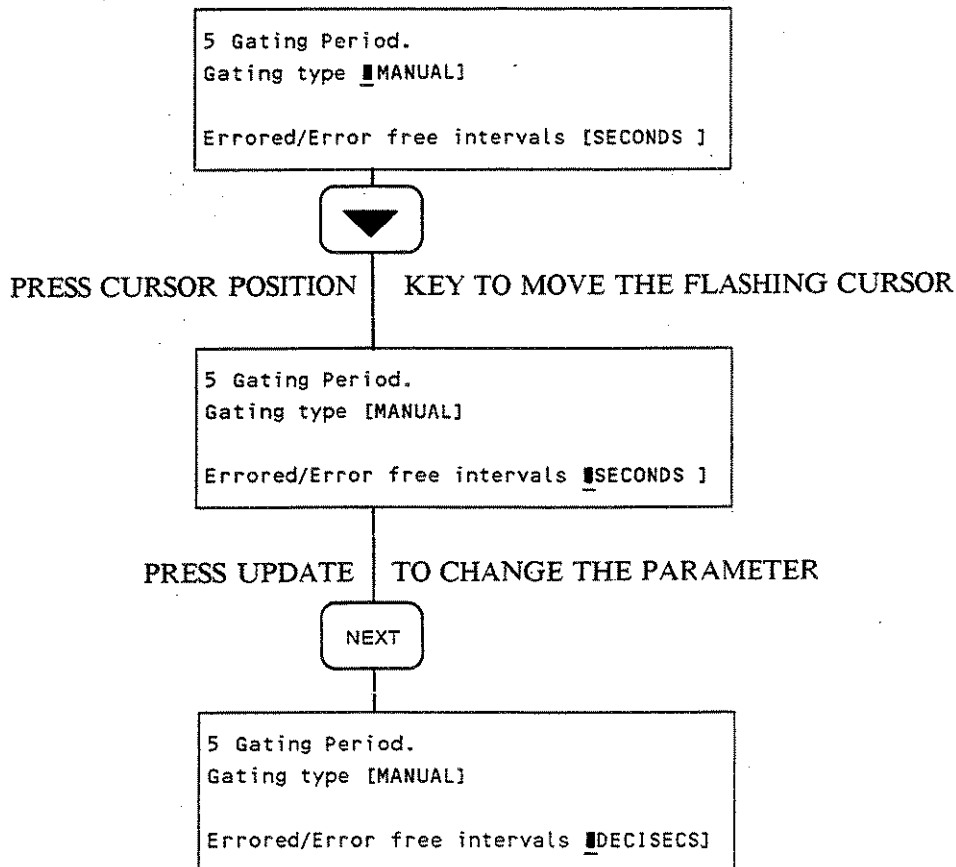

Front Panel Operating Features

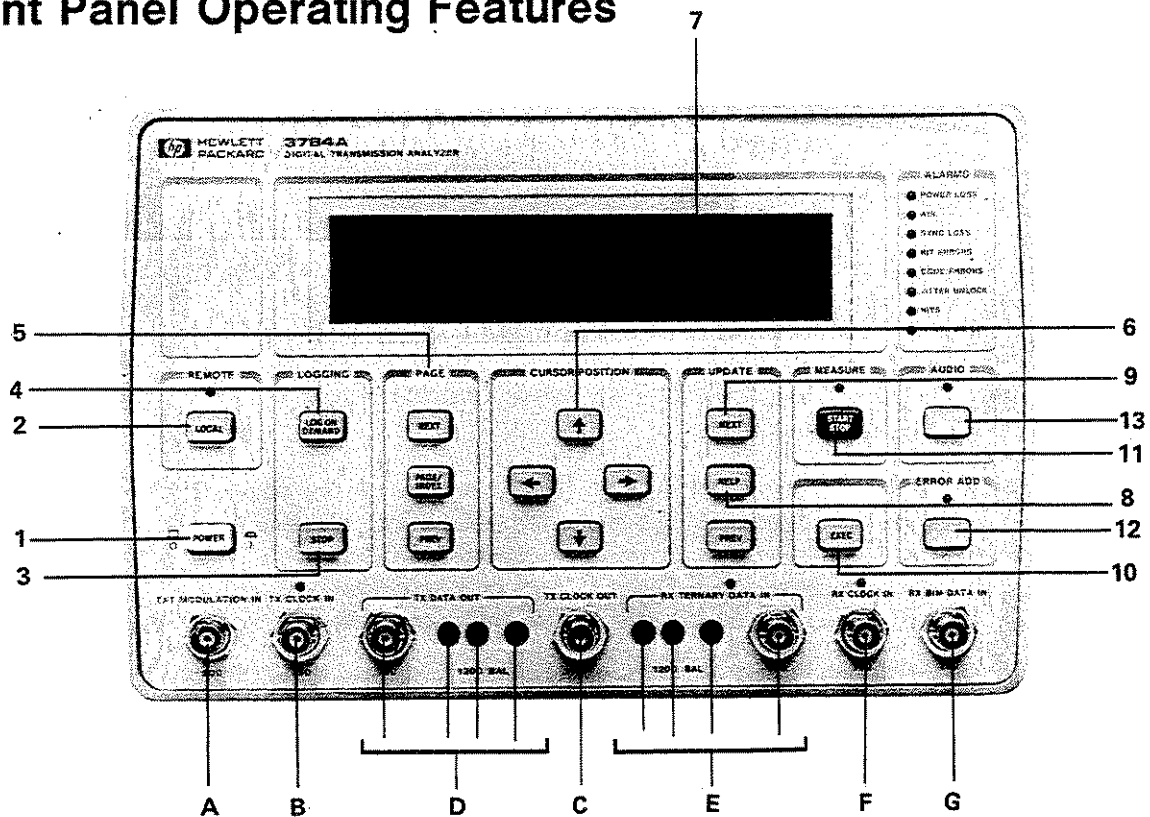

1. The POWER key switches the instrument power OFF and ON.
2. The LOCAL key returns the instrument to Local control after Remote Operation. When under remote control the led above the LOCAL key is illuminated.
3. Pressing the STOP key disables all logging operations. The Logging field on Page 7 Data Log is set to [DISABLED].
4. Pressing the LOG ON DEMAND key enables logging, if not previously enabled and records the current measurement results if the instrument is measuring. If the HP 3784A is not gating then pressing this key will print out a summary of the results from the last measurement, provided a suitable printer is connected to the appropriate rear panel HP-IB or RS232 printer port.
5. The PAGE **NEXT** and PAGE **PREV** keys allow you to step backwards and forwards through the Pages i.e. if Page 5 is displayed, pressing the PAGE **NEXT** key will display Page 6, whereas pressing the PAGE **PREV** key will display Page 4. The PAGE **NEXT** and PAGE **PREV** keys also step between Index 1 and Index 2 when an Index is displayed.
 The PAGE/INDEX key alternates the display between an Index and the information Page on the Index highlighted by the flashing cursor.
6. Use the CURSOR POSITION keys to position the flashing cursor on display fields to be changed within a Page or, when an Index is displayed, on the page number you wish to select.

7. The HP 3784A Display provides two functions as follows:
 - a. Gives a visual display of instrument status, configuration, results, functions etc. via information pages.
 - b. Enables the user to change instrument status/settings using the front panel PAGE, CURSOR POSITION and UPDATE keys.

Display Backlight

The HP3784A display backlight is enabled when any front panel key is pressed. If no key is pressed within fifteen minutes the light is switched off.

8. Pressing and holding down the HELP key gives a display of useful information relevant to the current Page and settings selected.
9. The UPDATE and UPDATE keys change the display field that the flashing cursor is positioned on. These keys are disabled when an Index is displayed.
10. The EXEC key is operative when Pages 1, 3, 11 or 12 are displayed and is used to execute functions within these Pages, e.g. recall a selected measurement preset.
11. The START/STOP key starts a new measurement or stops a current one. The gating period (selectable on Page 5) can be either MANUAL, in which case the key is pressed both to start and stop the measurement, SINGLE where the key starts the measurement and stops automatically or REPEAT where the key must be pressed to start and stop the measurement. The indicator above the key is illuminated during gating.
12. Errors can be added either singly or at a selected rate to the transmitter output data. To inject these errors manually it is necessary to select [MAN] on Page 2 and press the ERROR ADD key. When this mode is selected on Page 2 the indicator above the ERROR ADD key is illuminated.
13. Pressing the AUDIO key enables or disables the Audio facility. When it is enabled (the indicator above the key is illuminated) an audible tone sounds each time errors occur. The source of errors is selectable on Page 6 and the pitch of the tone is proportioned to the error ratio.

Front Panel Input/Output Ports

The following paragraphs provide a brief description and specifications summary for each of the HP 3784A front/rear panel input/output ports. Complete specifications are given in section 6 of this manual. There are a number of HP 3784A ports which are dual function i.e. they serve as either input/output ports or as a dual input port, they are: EXT MOD/ALT WORD, SELECTABLE PORT and RX REF CLOCK IN/OUT.

- A **EXT MOD/ALT WORD:** The EXT MOD/ALT WORD port is used for two separate functions as follows: as an Alternating Word External Input Port, or External Jitter Modulation Input Port.

1. Alternating Word External Input Port.

To operate in this mode set the **Pattern** and **Word** fields on Page 2 Tx Setup as follows: **Pattern** [ALT WORD], **Word** [RATE] [EXTERNAL]. (option 002 instruments only)

Specifications summary:

Impedance: 50 ohms nominal to ground.
Frequency Range: d.c. to 100kHz for square waves.

Input Voltage Range: 600mV to 3V p-p.
Threshold: Nominal ground.

An external signal applied to the port switches two fixed length 8 bit fully programmable words (Word A and Word B). Useful for checking Regenerator chains for the effect of high and low pattern density.

2. External Jitter Modulation Input Port (Option 002)

To apply an external modulation source to the HP 3784A select either a Jitter Tolerance or Jitter Transfer Function measurement on Page 4 Measurements, and then set the **Modulation** field to [EXTERNAL].

Enables external jitter modulation to be applied to the internally generated patterns. This permits the user to input low jitter frequencies not covered by the HP 3784A internal synthesizer, or even d.c. signals.

Frequency Range: Meets CCITT Rec. 0.171 Table 2 for sinusoidal modulation, and typically d.c. to 5% of the bit rate. Please refer to the HP 3784A Data Sheet or Service Manual for detailed specifications.

Note The ALT WORD RATE selection (on Page 2 Tx Setup) and the Jitter Modulation field selection (on Page 4 Measurements) are mutually exclusive i.e. If ALT WORD is set to [RATE] [EXTERNAL] then Modulation on Page 4 Measurements is set to [INTERNAL]. Similarly if the Modulation field on Page 4 is set to [EXTERNAL] then the ALT WORD [RATE] is set to Word [RATE] [10Hz] (i.e. internal modulation).

- B TX CLOCK IN:** An external clock source can be used as the transmitter clock. The valid frequency range is 1kHz to 50MHz. During jitter generation and measurement the frequency range is restricted to the internal fixed rates $\pm 10\%$.

The LED above the TX CLOCK IN port illuminates when clock transitions are detected at the port and Tx Clock [EXT] is selected. The frequency of the external clock is displayed on Page 2 Tx Setup. If option 002 is fitted, then the jitter modulators will autorange onto the correct frequency band, eg. if Tx EXT CLK is within 10% of a standard rate, then that modulator will be selected.

Specifications summary:

Impedance 75 ohms nominal to ground;

Minimum pulse width 8ns.

Sensitivity better than 500mV.

Amplitude 5V p-p max.

- C TX CLOCK OUT:** Clock Output Level is user selectable on Page 2 Tx Setup and is as follows:

TTL into 75 ohms to ground or ECL into 75 ohms to -2V. Selection of ECL or TTL is common for Data and Clock ports and is selectable when Binary interface is selected, i.e. [BINARY] [TTL]. The choice of ECL or TTL is permanently linked with that of the Receiver.

If Ternary operation is selected the ECL/TTL field is not displayed on Page 2, eg. [75TERM] [HDB3]. The clock output level in Ternary operation is as selected for Binary operation.

- D TX DATA OUT:** Two output connectors are provided: an unbalanced 75 ohm port and a 3 pin Seimens balanced 120 ohms port.

120 ohms balanced: This port provides output signals at 64kbit/s (option 006 only), 704kHz and 2MHz. At 64kHz the interface is co-directional, while at the other bit rates AMI/HDB3 (selectable on Page 2 Tx Setup) is used.

Unbalanced 75 ohms: Provides output data at all bit rates (except 64 kbit/s) and with Binary or Ternary interfaces. Binary level is ECL/TTL and is NRZ; Ternary is AMI/ HDB3 selectable on Page 2 Tx Setup. The Tx Data Output amplitude is shown in the following Table:

Table 2-2. Tx Data Output Amplitude

Nominal Bit Rate (kHz)	64	704	2048	8448	34368
Peak Voltage $\pm 10\%$ (75 ohm)	-	2.37	2.37	2.37	1.00
Peak Voltage $\pm 10\%$ (120 ohm)	1.00	3.00	3.00	---	---

E RX TERNARY DATA IN: Accepts Ternary signals at the following four fixed frequencies and coding format.

64kHz: co-directional interface - option 006 instruments.

704kHz: AMI with up to 24 zeros or HDB3

2048kHz: AMI with up to 24 zeros or HDB3

8448kHz: HDB3

34368kHz: HDB3

Rate Tolerance is ± 100 ppm and pulse width 50% $\pm 6\%$ of bit period. Impedance is 75 ohms nominal unbalanced to ground at the higher four bit rates, and 120 ohms nominal selectable for 64kHz (option 006), 704, 2048 and 8448kHz.

F RX CLOCK IN: This port accepts an external clock signal in the frequency range 1kHz to 50MHz. An LED above the port is illuminated if clock transitions are present and the Receiver is set to Binary, or Thru data is selected. This 75 ohms unbalanced input is ac coupled and has a sensitivity compatible with TTL or ECL levels.

G RX BIN DATA IN: Accepts binary data in NRZ format in the frequency range 1kHz to 50 MHz. Data Input is user selectable; TTL into 75 ohms to ground, or ECL into 75 ohms to -2V.

Alarms

POWER LOSS: This led illuminates when power is restored after a power loss which occurred during the instrument gating. The led does not illuminate following a power loss when the instrument is not gating. When this alarm is illuminated it will remain so until a new gating (measurement) period is initiated via the **START/STOP** key.

AIS: The Alarm Indication Signal led indicates that an all ones pattern is being received. This detector conforms to CCITT 0.162, i.e. it flags AIS if in 2200 clocks there are less than 3 zeroes.

SYNC LOSS: This led illuminates to indicate that the receiver has lost reference pattern synchronisation. The criteria for sync loss is Error Ratio $\geq 1/9$ and sync gain is Error Ratio $\leq 1/100$.

BIT ERRORS: This led illuminates on the occurrence of bit errors.

CODE ERRORS: This led illuminates on the occurrence of code errors, when the code errors measurement is selected.

JITTER UNLOCK: This led illuminates when the jitter measurement has lost the reference against which it is currently measuring.

HITS: This led illuminates on the occurrence of jitter hits

SYNTH UNLOCK: This led illuminates when the user requests a new clock synthesiser frequency on Page 2. When this led is lit it will remain so until the new frequency is achieved.

Rear Panel Input/Output Ports

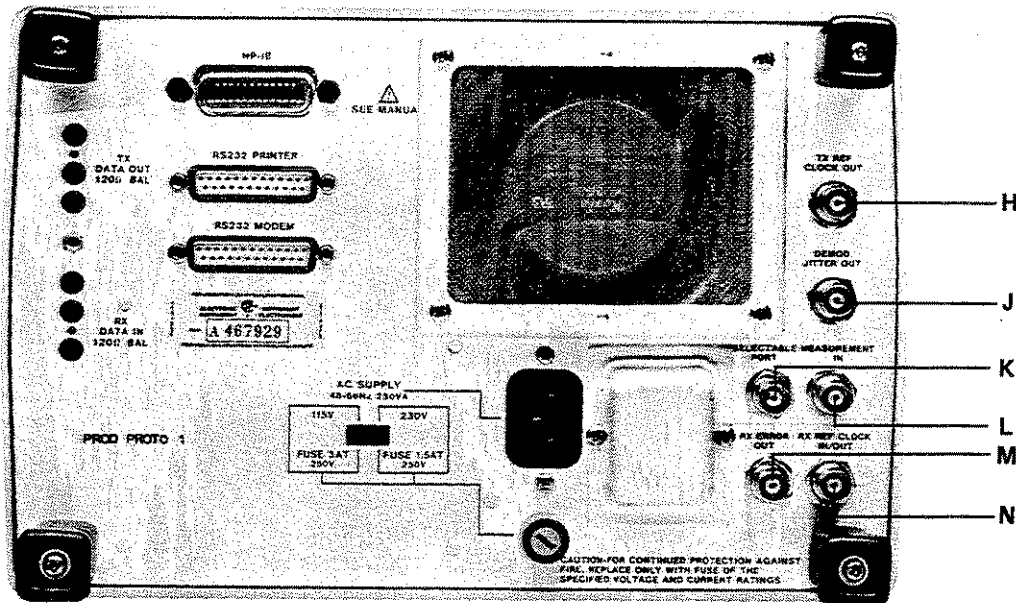

H TX REF CLOCK OUT: Provides an unjittered version of the Tx Reference Clock.

Source: Internal or external clock.

Format: Continuous.

Impedance: Nominal low, unbalanced to GND.

Amplitude: Nominal ECL levels.

External Load: 50 ohms to -2V dc coupled or 50 ohms to GND ac coupled.

J DEMOD JITTER OUT: Amplitude on Range 1 is 1.0V/UI (p-p), and on Range 10 is 0.1V/UI (p-p). Range selection is made on Page 4 Measurements. This output can be used to:

a. View the jitter spectrum on a Spectrum Analyzer.

b. Measure the rms value of the received jitter.

c. In conjunction with the MEASUREMENT IN port, allows external filters to be applied before the jitter measuring circuitry.

K SELECTABLE PORT: This port is dual function, giving an output of either Tx Trigger or Rx Clock. Output selection is performed in the Selectable Port field on Page 10 Rear Panel Ports.

Impedance: Nominal low, unbalanced to GND.

Amplitude: Nominal ECL levels.

External Load: 50 ohms to -2V dc coupled, and 50 ohms to GND ac coupled.

If [TX TRIG OUT] is selected an output pulse is given coincident with the start of the longest run of 0's for PRBS patterns, and the start of the binary word for WORD patterns.

[RX CLOCK OUT] - In Ternary operation the recovered clock from the input data is output, while for binary operation the received binary clock is output.

The Rx Clock Out frequency may be checked by connecting the **SELECTABLE Port** to the **TX CLOCK IN** port and reading the frequency on Page 2 Tx **Setup** display. This is only possible when the HP3784A Transmitter is not being used. If a binary interface is selected Rx Frequency measurement is also displayed on Page 4 Error Results.

- L **MEASUREMENT IN:** The **MEASUREMENT IN** port is enabled/disabled at the **Measurement In** field on Page 10 Rear Panel ports. Selecting [ENABLE] disconnects the jitter measurement and hit counting circuitry from the internal demodulated jitter source, and connects them to the **MEASUREMENT IN** port. This permits the user to insert external filters between the **DEMOD JITTER OUT** port and the measurement circuits. It can also be used to record voltages with the logged data, or for triggering logging on voltages exceeding a user defined threshold (jitter hit threshold).

Impedance: 1 kilohm.

- M **RX ERROR OUT:** Provides an output pulse for every Bit or Code error received, as selected in the **Error Out** field on Page 10 Rear Panel ports. Pulse width is nominally one clock period.

- N **RX REF CLOCK IN/OUT:(option 002)** Provides an **OUTPUT** of the derived reference clock when using the internal reference, or serves as the **INPUT** for an external reference. Rx Reference Clock selection is provided at the **Rx Reference Clock** field on Page 10 Rear Panel Ports. An explanation of each operating mode is as follows:

Rx Reference Clock Input Mode: In this mode the port serves as an input for an external clock. The **Rx Reference Clock** field on Page 10 Rear Panel Ports is set to [EXT]. In this mode the **JITTER UNLOCK LED** is disabled as the reference is always in **LOCK**.

Specifications are as follows:

Frequency Range: 2048 kHz to 34368 kHz

Impedance: Unbalanced 50 ohms nominal.

Termination: Nominal -2V.

Sensitivity: Nominal ECL levels.

Protection: 100mA fuse.

Rx Reference Clock Output Mode: Provides an output of the derived reference clock. The format is continuous. The **Rx Reference Clock** field on Page 10 Rear Panel Ports is set to [INT]. In this mode, the **JITTER UNLOCK LED** is enabled and reflects the condition of achieving the reference clock.

Self Test Features

Introduction

The HP 3784A provides a self test facility which checks over 90% of the instrument internal circuits to ensure the HP 3784A is functioning correctly. This is particularly useful for checking that the instrument is functioning correctly after transportation to remote sites and before making measurements.

Enabling Self Test

Select Page 12 Self Test and set the Function field to the test you wish to perform. For some of the tests it is necessary to connect the HP 3784A back-to back, or in the case of RS-232-C insert a loop-back plug (Part Number 5060-4462) in the appropriate port. An example of Page 12 Self Test and a list of the tests available, and cabling required is as follows.

```
12 Self Test. Function [BER/INTFACE TST]
BER & Interface test..... ----
Cable required interface back to back.
Press EXEC. to run self-test.
```

Option Instruments

On Option Instruments there is a user-selectable field on Page 12 Option/Self Test called "Instrument Type", see following display.

```
12 Self Test. Function [TYPE & REVISION]
Instrument Type. 3784A [Option 002]
Firmware Revision Number. 0000
```

This field enables you to switch off any option the instrument has fitted, thus reverting it to a standard model. This feature may be useful if your instrument includes Option 002 Jitter Generation/Measurement but you intend only to make Bit or Code Error Measurements. Remember however, to reset the "Instrument Type" field on Page 12 to [Option 002] should you then wish to perform Jitter Measurements.

Default Settings

Default Settings for the HP 3784A are listed in Table 2-4.

Table 2-3. Self Tests

Self Test	Page 12 Function field selection	Cabling
Test CPU	[TEST CPU]	No cabling required.
RS-232-C Modem Port	[TEST MODEM PORT]	Insert loop-back plug in rear panel RS232 MODEM port.
RS-232-C Printer Port	[TEST PRINT PORT]	Insert loop-back plug in rear panel RS232 PRINTER port.
Clock Synthesiser	[TEST CLCK SYNTH]	Connect TX CLOCK OUT port to RX CLOCK IN port.
Pattern Generation Bit Error Generation	[BER/INTFACE]	For Ternary operation connect TX DATA OUT to RX TERNARY DATA IN. For Binary operation connect TX DATA OUT to RX BIN DATA, and TX CLOCK OUT to RX CLOCK IN.
Code Error Generation	[BER/INTFACE]	Only available in Ternary operation. Connect the TX DATA OUT to RX TERNARY DATA IN.
Jitter Tests (option 002)		
All Tests	[ALL]	Connect TX DATA OUT to RX TERNARY DATA IN and TX CLOCK OUT to RX CLOCK IN.
Clock Jitter	[CLOCK IO]	Connect TX CLOCK OUT to RX CLOCK IN.
Data Jitter	[DATA IO]	Connect TX DATA OUT to RX TERNARY DATA IN.
Modulation/Hits test Filter Test	[FREQ/HIT] [FILTERS]	Connect TX CLOCK OUT to RX CLOCK IN.

Table 2-4. Default Settings (continued)

Printer:	
Baud Rate	9600
Parity	None
Stop Bits	1
ENQ/ACK	Off
XON/XOFF	Off
HP-IB Remote Control: (See Note 2)	
Address	5
Source of remote control	HP-IB
RS232 Remote Control: (See Note 2)	
Connection	Modem
Baud Rate	1200
Ci Low	1800
Ci High	600
Parity	Ones
Stop Bits	1
DTR	Off
Duplex	Full
ENQ/ACK	Off
XON/XOFF	Tx Only

NOTES:

- (1) Default only if Jitter option fitted.
- (2) These settings unaffected by "RST" or 'RCL 0" but are set to these values following NVM failure.
- ** This default only when [VAR] source selected following reset.

Introduction

This section explains how to make measurements with your HP 3784A, how to display the results and how to use error analysis to obtain useful information about your equipment under test.

Whether you are developing and testing new equipment, routine testing the transmission network, or fault-finding on a transmission line you need to make measurements which give an accurate indication of the quality of the equipment under test. The HP 3784A enables you to measure Binary and Code Errors, carry out Error Analysis, make Alarm Duration Measurements and measure Frequency and Offset values. If you have an HP 3784A Option 002, you can also generate and measure jitter.

What Measurements does the HP 3784A perform?

The HP 3784A performs four types of measurements; Error Measurements, Error Analysis, Alarm Duration Measurements and Slip Measurements. Option 002 adds Jitter Generation and Measurement capability. Option 006 adds CCITT 64 kbit/s codirectional interfaces.

Error Measurements

The HP 3784A can be used to measure both bit and code errors. Measurement results can be displayed on Page 4 [ERROR RESULTS] as :

- Error Count
- Error Ratio
- Error Seconds
- Error Free Seconds

All four are calculated throughout a measurement although only one result can be displayed at any time.

At ternary interfaces, bit and code errors can be measured simultaneously.

At binary interfaces, only bit errors can be measured.

Error Analysis Measurements

The HP 3784A automatically carries out error analysis of the bit error results. The analysis is based on CCITT Recommendation G.821 and can be viewed on Page 4 [ERROR ANALYSIS]. The eight different classes of analysis are listed below. Those based on CCITT Rec. G.821 are marked with an asterisk thus * and are measured for "available" time.

- % Availability *
- % Unavailability
- Error Bursts
- Asynchronous Error Seconds
- % Degraded Minutes *
- % Severely Errored Seconds *
- % Errored Seconds *
- Long Term Mean Error Ratio

Alarm Duration Measurements

In addition to Error and Analysis measurements, the duration of several alarm conditions can be monitored. These alarms are monitored simultaneously with other measurements, and are selected on Page 6 Alarms, an example of which is given below.

```
6 Alarms.  
Audio source [BIT ERRORS ]  
Duration of [RX CLK LOSS].....Secs  
Cumulative Slip Decisecs.....Secs
```

The 3784A performs the following Alarm Duration Measurements:

- Power Loss
- AIS (Alarm Indication Signal)
- Sync Loss
- Data Loss
- RX Clock Loss
- TX Clock Loss

Slip Measurement

A Slip Measurement can be made when the receiver is configured to receive a PRBS pattern.

For a Slip to be counted, the input signal must be recognized to be part of the PRBS pattern but time shifted from the receiver reference pattern. The slip is recorded and the receiver then synchronizes its internally generated reference PRBS pattern to the incoming signal. The HP 3784A is capable of detecting one slip per decisecond (0.1 second).

A "slip decisecond" is defined as a decisecond in which one or more slips occur.

The slip measurement result is seen on Page 6 Alarms. It is given as "Cumulative Slip Deciseconds" which is the number of slip deciseconds divided by 10.

Jitter Measurements (Option 002 instruments)

Option 002 adds Jitter Generation and Measurement capability to the standard HP 3784A. An important feature of this option is the ability to perform Automated Jitter Tolerance and Jitter Transfer plotting in addition to various manual measurements. The jitter measurements provided are:

- Automatic Tolerance Plotting
- Automatic Jitter Transfer Plotting
- Output Jitter
- Jitter Transfer Function
- Jitter Tolerance

64 kbit/sec Codirectional Interfaces (Option 006)

Option 006 adds 64 kbit/s codirectional interfaces to the standard HP 3784A. The error performance analysis at these interfaces is based on bit error count rather than bit error ratio results.

Making a Measurement

The HP 3784A is configured to make a measurement using the front panel keys to set the appropriate parameters in the liquid crystal display. If you are not familiar with using this type of menu-driven instrument, refer to the "Getting Started" section on page 2-1 for introductory operating instructions.

Transmitter Setup

The first stage to making any measurement is to select the transmitter interface, the data rate and the test pattern. On the HP 3784A these selections are made on Page 2 Tx Setup.

```
2 Tx Setup.   Data Out [ 75 TERM] [HDB3]
Clock [STD RATE] [34 MHz] Offset [ +0]ppm
Pattern [PRBS] - [23]       Zero Sub [000]
Er Add [BIT ] [OFF ]       Clock Out [NORM]
```

Receiver Setup

After setting the transmitter parameters, you next configure the receiver on Page 3 Rx Setup. It can be linked to the transmitter, in which case all the parameters mirror the transmitter exactly, or it can be setup independently.

```
3 Rx Setup.   [ AS TX ]

Jitter Display Rate [FAST]
```

Note: The Jitter Display Rate field is only displayed for option 002 instruments.

The receiver can also be setup automatically to match the incoming data. Details on how this is done are given on page 3-5 in "Receiver Auto- Configure".

Gating

Next the gating type and length are selected on Page 5 Gating Period.

```
5 Gating Period.
Gating type [MANUAL]

Errored/Error free intervals [SECONDS ]
```

Measurements and Results

When the transmitter, receiver and gating have been set up, you are ready to make a measurement and display the results on Page 4 [ERROR RESULTS].

```
4 [ ERROR RESULTS ] (Tx Jitter On)
Elapsed time..... 00d 00h 00m 00s
Rx [CODE ERR.][COUNT].....
Rx Bit Error [COUNT].....
```

Error Analysis Results can also be displayed on Page 4.

Storing Measurement Configuration

The complete instrument configuration can now be stored in internal non-volatile memory to be recalled later. This allows you to make the measurement again quickly and easily without setting each parameter individually.

"Storing and Recalling Measurement Configurations" on page 3-19 explains how this is done.

Receiver Auto-Configure

The HP 3784A receiver can be set to automatically identify a data signal input to one of its interfaces at any of the standard rates and patterns. This is particularly useful when making end-to-end BER measurements with the two instruments in different locations. The transmitter at one end of the line is set to the chosen data rate and test pattern. The receiver at the other end is then set to autoconfigure on the incoming data, reducing the test setup time and eliminating instrument set-up errors.

NOTE

If the receiver is unable to lock onto the incoming data, the front panel SYNC LOSS led is illuminated and the receiver display page, Page 3, shows its "best attempt" at recognizing the data.

If the incoming data contains only runs of less than three consecutive zeros, the receiver will be unable to distinguish between AMI and HDB3 coding, and the Data field on Page 3 may be set incorrectly.

If an input PRBS pattern contains substituted zeros, the receiver can recognize the PRBS pattern but does not set the zero substitution field.

The following procedure demonstrates the use of the Auto-Configure capability.

Procedure

1. Switch on the HP 3784A.
2. Connect the TX DATA OUT port to the RX TERNARY DATA IN port.
3. Select Page 1 Preset [PANEL], set to Function [RECALL FROM] Panel Memory [0] and press the **EXEC** key. The display will blank momentarily as the instrument is set automatically to its default settings.
4. Select Page 2 Tx Setup and check that it is set as follows:

```
2 Tx Setup.   Data Out [ 75 TERM] [HDB3]
Clock [STD RATE] [34 MHZ] Offset [ +0]ppm
Pattern [PRBS]- [23]       Zero Sub [000]
Er Add [BIT ] [OFF ]      Clock Out [NORM]
```

5. Select Page 3 Rx Setup and set as follows:

```
3 Rx Setup [AUTO]

Connect test signal(s)...
Then press EXEC. key to start autosetup.
```

6. Check the transmitter and receiver connections and press the **EXEC** key.

Page 3 Rx Setup displays **Autosetup** executing. Please Wait. The HP 3784A display should be set automatically as shown below:

```
3 Rx Setup [MAN] Data In [75 TERM] [HDB3]
Clock [NORM]           Clock Rate [34 MHZ]
Pattern [PRBS]- [23]   Zerosub [000]
Jitter Display Rate [FAST]
```

Note: the Jitter Display Rate will only appear if your instrument is Option 002.

Making Out-of-Service Error Measurements

In this section procedures are given for making out-of-service bit and code error measurements on coded ternary and binary TTL level data. Each measurement example describes how to set up the transmitter, receiver and gating period and display the measurement result.

Out-of-service measurements can be made either on systems disconnected from the network or during the manufacture and test of digital transmission equipment. In both cases you must have a suitable pattern source for testing the performance of the equipment under conditions which reflect the real operating conditions.

A test pattern is used to simulate the live traffic and the output of the system under test is monitored for bit errors.

Each measurement example starts with setting the HP 3784A to its default settings. The measurement configurations are then derived from this point.

NOTE

When making measurements on coded ternary data, the data rate must be within +/- 120 ppm of one of the standard clock rates as specified for the receiver RX TERNARY DATA IN port.

Bit Error Measurement on Coded Ternary Data

Out-of-service, the HP 3784A can measure both bit and code errors simultaneously at ternary interfaces.

In this measurement example, single bit errors are added to the transmitter PRBS test pattern and counted by the receiver over a MANUAL gating period.

Table 3-1 below lists the PRBS test patterns recommended in CCITT Rec. O.151 and O.152 for making out-of-service measurements at each of the standard data rates.

Table 3-1. PRBS Test Patterns

Data Rate (kbits)	PRBS
64	$2^{11}-1$
2048	$2^{15}-1$
8448	$2^{15}-1$
34368	$2^{23}-1$

Procedure

1. Connect HP 3784A TX DATA OUT port to RX TERNARY DATA IN port.
2. Select Page 1 Preset [PANEL] and set the instrument to its Default Settings by recalling Panel Memory 0.
3. Select Page 2 Tx Setup and set to Er Add[BIT][MAN]. Check that the led above the front panel ERROR ADD key comes on, indicating that it is enabled.
4. Select Page 4 [ERROR RESULTS] and ensure that Rx Bit Error [COUNT] is selected.
5. Press the MEASURE **START/STOP** key and press the ERROR ADD key a few times during the gating period. Verify the Rx Bit Error [COUNT] result increments and the front panel BIT ERRORS led comes on each time. Verify that there are no code errors.
6. Press the MEASURE **START/STOP** key again to terminate the gating period.

Note: If you also want to count code errors and monitor the front panel CODE ERRORS led, ensure that Rx[CODE ERRORS] is selected on Page 4 [ERROR RESULTS], otherwise Frequency Offset will be measured and the CODE ERRORS led will be disabled.

Code Error Injection and Measurement

Code error injection can be used to verify that network alarm systems and error correction systems are operating correctly.

In this example, code errors are added to the transmitter HDB3 coded PRBS test pattern and measured at the receiver. Adding HDB3 Code Errors also introduces Bit Errors.

Procedure

1. Connect TX DATA OUT port to RX TERNARY DATA IN port.
2. Select Page 1 Preset[PANEL] and set instrument to its Default Settings by recalling Panel Memory 0.
3. Select Page 2 Tx Setup and set to Er Add[CODE][RATE]-[3].
4. Select Page 4 [ERROR RESULTS] and set to Rx[CODE ERR.][RATIO].
5. Press the MEASURE **START/STOP** key and verify the Code Error Ratio result is approximately 1.165E-03.
Note that adding HDB3 code errors to the data also causes bit errors to be introduced.
6. Press the MEASURE **START/STOP** key to terminate the measurement.

Bit Error Ratio Measurement at Binary TTL Interfaces

Measurements on binary data can be made at each of the standard data rates and at any rate between 1 kbit/s and 50 Mbit/s.

When making measurements on binary data, the HP 3784A receiver must be supplied with both the binary data and its corresponding clock signal. It is important that the correct phase relationship between the clock and data signals is maintained at the receiver interface. Two methods can be used to ensure they are in phase. The first is to alter the relative length of the two cables connecting the signals to the receiver inputs. The second is to invert the clock signal at either the transmitter or receiver by setting the Clock Out field on Page 2 Tx Setup or the Clock field on Page 3 Rx Setup respectively to [INV]

In this example the HP 3784A transmitter is set to output a $2^{15} - 1$ PRBS pattern at 2.048 Mb/s. Errors are added to the output data at a rate of 1 in 10^3 . The receiver is set to make measurements over a repetitive gating period. Measurement results are displayed as Bit Error Ratio.

Procedure

1. Connect TX DATA OUT to RX BIN DATA IN and TX CLOCK OUT to RX CLOCK IN.
2. Select Page 1 Preset Panel and set the HP 3784A to Default Settings by recalling Panel Memory 0.
3. Select Page 2 Tx Setup and set to the following:

```
2 Tx Setup.   Data Out [ BINARY ] [TTL ]
Clock [STD RATE] [ 2 MHz] Offset [ +0]ppm
Pattern [PRBS] - [15]      Zero Sub [000]
Er Add (bit) [RATE] - [3] Clock Out [NORM]
```

4. Select Page 3 Rx Setup and set to [AS TX].
5. Select Page 5 Gating Period and set to the following:

```
5 Gating Period.
Gating type [REPEAT]
Period [ 0]d [ 0]h [ 0]m [ 5]s
Errored/Error free intervals [SECONDS ]
```

6. Select Page 4 [ERROR RESULTS] and set to the following:

```
4 [ ERROR RESULTS ] (Tx Jitter On)
Elapsed time..... 00d 00h 00m 00s
Rx Frequency..... Hz
Rx Bit Error [ RATIO ].....
```

The Elapsed Time shown is from the previous measurement.

7. Press the MEASURE **START/STOP** key.
8. Verify that after 5 seconds the Bit Error Ratio result displayed is 1.000 E -3
9. Press the MEASURE **START/STOP** key to terminate the measurement.

Bit Error Count Measurement at Binary TTL Interfaces

In this example the transmitter and receiver are connected back-to-back and the receiver is configured automatically to the incoming binary data and clock signals. The error measurement is made over a single 20 second gating period. Single errors are added manually to the transmitter output data and counted at the receiver.

Here an 8-bit WORD pattern is set up. Any WORD pattern of between 1 and 16 bits can be programmed and used to test a system. For example, a low density ones pattern can be used to test the clock recovery capability of an input clock recovery circuit.

Procedure

1. Connect TX DATA OUT port to RX BINARY DATA IN port and TX CLOCK OUT port to RX CLOCK IN port.
2. Select Page 1 Preset [PANEL], set to [RECALL FROM] Panel Memory [0] and press the **EXEC** key to set the instrument to its Default Settings.
3. Select Page 2 Tx Setup and set to the following:

```
2 Tx Setup:      Data Out [ BINARY ] [ TTL ]
Clock [ STD RATE ] [ 34 MHz ] Offset [ +0 ] ppm
Pattern [ WORD ] [ 8 ] Bit [ 10110101 ]
Er Add (bit) [ MAN ]      Clock Out [ NORM ]
```

Verify the led above the front panel ERROR ADD key is on.

4. Select Page 3 Rx Setup and set to [AUTO].

5. Press the **EXEC** key. Wait while the auto-configure routine is executed, and then verify the receiver is set up as shown below:

```
3 Rx Setup [MAN] Data In [BINARY][TTL ]
Clock [NORM] Jitter Clock Rate [34 MHz]
Pattern [WORD] [8]Bit [10110101 ]
Jitter Display Rate [FAST]
```

6. Select Page 5 Gating Period and set as shown below:

```
5 Gating Period.
Gating type [SINGLE]
Period [ 0]d [ 0]h [ 0]m [ 5]s
Errored/Error free intervals [SECONDS ]
```

7. Select Page 4 [ERROR RESULTS].
8. Press the MEASURE **START/STOP** key to start the gating period.
9. Now press the ERROR ADD key a few times during the gating period and verify that the Rx Bit Error [COUNT] increments each time.

Making In-Service Code Error Measurements

In-Service Measurements

The HP 3784A can be used to make in-service code error measurements on live traffic at the appropriate interface points in the system under test. With Option 002, output jitter can also be measured. A Code Error is counted when a violation in the coding of the incoming data is detected by the receiver. The Bit Error Performance can be estimated from the Code Error results. Although this method of error analysis is slightly less accurate than the out-of-service method, it does have the advantage that the network line does not have to be removed from revenue generating service.

Code Error Measurement on Live Traffic - In-service

The HP 3784A can be used to measure code errors on live traffic, provided the data rate is nominally at one of the four instrument rates of 704, 2048, 8448 or 34368 kbit/s. The only information required at the receiver is the coding scheme used at the data transmitter. For AMI data, a code error is counted when a bipolar violation is detected. For HDB3 data, a code error is counted when a violation of a violation or a run of more than three zeros is detected.

The Frequency Offset can also be measured on live traffic.

Monitor Mode

The HP 3784A provides a "MON" mode for use when making measurements on live data at protected monitor points on distribution frames or other operational equipment. When this mode is selected, a monitor amplifier is switched in at the receiver to provide additional gain for the data signal.

Note: When the HP 3784A is being used to measure code errors in live data the instrument SYNC LOSS and BIT ERRORS leds are illuminated. This is due to the receiver being unable to lock on to the incoming data pattern and does not affect the Code Error Count result.

Procedure

1. Connect the live traffic from the appropriate G.703 interface point on the operational equipment, to the HP 3784A RX TERNARY DATA IN port.
2. Select Page 3 RX Setup and set to Data In[75 MON][HDB3]. Set the data rate to the correct value for your traffic.
3. Now select Page 5 Gating and set the gating period type and length.
4. Select Page 4 Measurements and set as follows:

```
4 [ ERROR RESULTS ] (Tx Jitter On)
   Elapsed time..... 00d 00h 00m 05s
   Rx Code Error [COUNT].....
   Rx Bit Error [COUNT].....
```

5. Press the MEASURE **START/STOP** key and view the results on the display.

Error Analysis Measurements

When you make an out-of-service error measurement, error analysis based on CCITT Rec. G.821 is automatically carried out on the bit error results. The analysis is divided into eight categories which can be viewed on Page 4 [ERROR ANALYSIS].

- % Availability *
- % Unavailability
- Error Bursts
- Asynchronous Error Seconds
- % Degraded Minutes *
- % Severely Errored Seconds *
- % Errored Seconds *
- Long Term Mean Error Ratio

All the analysis is carried out for "available" time.

"Available" time is defined as the total time less the "unavailable" time. An "unavailable" period begins when the error ratio is worse than 1×10^3 for 10 consecutive seconds. It is only deemed available again when the error ratio has been better than 1×10^3 for 10 consecutive seconds.

% Availability

% Availability is defined as the ratio of the "available" seconds in the measurement interval to the total number of seconds in the measurement interval. "Available" is a term used by CCITT to indicate that a link is suitable for reliable transmission.

% Unavailability

% Unavailability is the ratio of unavailable seconds in the measurement period to the total number of seconds in the measurement period.

Analysis PASS/FAIL Thresholds

Each of the analysis results can be compared automatically against a user-selectable threshold. If the result of any of the analysis measurements falls below the threshold value, then the **Overall** and **Individual Result** fields on Page 4 will register a "FAIL". For the HP 3784A to register a PASS, the result must be better than or equal to the threshold value. Refer to Appendix A for a definition of each Analysis measurement.

Note: If more than one Analysis "Individual result threshold" has been set, then ALL the individual results must pass for the "Overall" field to register a "PASS".

Error Analysis Example

In this example error analysis of the bit error measurement results is carried out over a single 30 second gating period. The HP 3784A counts the number of "Errored Seconds" in the gating period and expresses the result as a percentage of the total number of seconds in the gating period. An Errored Second is one which contains one or more errors. If you choose to set an Individual Threshold, then the instrument will also display a PASS or FAIL result, depending on whether or not the percentage Errored Seconds in the gating period was below or above the preset level. If you set more than one individual threshold, all the results must be better than their individual thresholds for an overall pass result to be given.

Procedure

1. Select Page 1 Preset [PANEL] and set the HP 3784A to its Default Settings by recalling Panel Memory 0.
2. Connect the HP 3784A TX DATA OUT port to RX TERNARY DATA IN port.
3. Select Page 2 Tx Setup and set to Er Add [BIT][MAN].
4. Select Page 5 Gating Period and set to the following:

```
5 Gating Period.  
Gating type [SINGLE]  
Period [ 0]d [ 0]h [ 0]m [30]s  
Errored/Error free intervals [SECONDS ]
```

5. Select Page 4[ERROR ANALYSIS] and set to the following:

```
4 [ ERROR ANALYSIS ] (Tx Jitter On)  
Result [ERRORED SECS ].....%  
Individual result thres. [YES] [20.0%]  
Overall. ---- Individual Result. ----
```

6. Press the MEASURE **START/STOP** key.
7. Press the ERROR ADD key a few times, wait a few seconds and press it again. At the end of the gating period the Error Analysis will display the percentage of errored seconds in the gating period and, a PASS/FAIL result to indicate whether or not the measurement result was better than the threshold value.

Additional Measurements

The following measurement examples make use of some of the HP 3784A features not described in the previous pages. A brief description on the application is given in the introduction to each one.

Using Zerosubstitution

Zeros can be substituted into the transmitter output PRBS pattern in order to test the tolerance of an input clock recovery circuit to long runs of zeros at its input.

The zero-substituted binary or AMI test pattern is applied to the input of the system under test, and the signal at the system output is then monitored for bit errors or jitter content. Up to 999 zeros can be substituted into the PRBS pattern. Substitution starts at the first zero in the longest run of zeros in the PRBS. If the bit immediately following the substituted zeros is also a zero, this is replaced with a binary one.

In the following procedure, an equipment clock recovery circuit is tested for tolerance to zeros in a $2^{23} - 1$ PRBS pattern at 34 Mbit/s.

Procedure

1. Connect the equipment as shown in Figure 3-1 below:

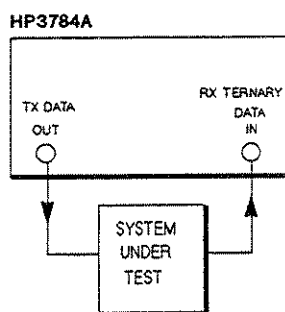

Figure 3-1 Equipment Setup

2. Select HP 3784A Page 1 Preset [PANEL] and set the instrument to its default settings by recalling Panel Memory 0.
3. Select Page 2 Tx Setup and set as follows:

```
2 Tx Setup.   Data Out [ 75 TERM] [AMI]
Clock [STD RATE] [34 MHz] Offset [ +0]ppm
Pattern [PRBS] - [23]       Zero Sub [000]
Er Add [BIT ] [OFF ]      Clock Out [NORM]
```

4. Now increase the number of substituted zeros until the BIT ERRORS led is illuminated. This is the tolerance limit of the equipment input to zeros in the data.

Frequency Measurement

When the HP 3784A is configured to make measurements on binary data, the frequency of the binary clock signal is automatically measured and the result displayed on Page 4 [ERROR RESULTS], whether or not the instrument is gating.

In this example, to demonstrate the use of a non-standard clock rate, the transmitter clock is set to "Variable" at 1 MHz. The pattern is set to an 8-bit WORD. The clock frequency and number of bit errors measured by the receiver, are displayed on Page 4 [ERROR RESULTS].

Procedure

1. Connect the TX DATA OUT port to RX BIN DATA IN port and the TX CLOCK OUT port to the RX CLOCK IN port.
2. Select Page 1 Preset [PANEL] and set the instrument to its default settings.
3. Select Page 2 Tx Setup and set to the following:

```
2 Tx Setup.   Data Out [ BINARY ] [TTL ]
Clock [VAR] [ 1000.0]KHz  Offset [ +0]ppm
Pattern [WORD] [8] [10110110]
Er Add (bit) [OFF ]      Clock Out [NORM]
```

4. Select Page 4 [ERROR RESULTS] and verify the measured frequency is 1000000 ± 6 Hz.
5. Press the MEASURE key. Verify the Rx Bit Errors [COUNT] is 0 and the Rx Frequency is still 1000000 ± 6 Hz.

Frequency Offset Measurements

The Frequency Offset Measurement is made on the clock recovered from the input coded ternary data. When you select this measurement on Page 4 [ERROR RESULTS], the Code Error Measurement is disabled although you can still measure bit errors.

CCITT Recommendation G.703 specifies that the network data rates should lie within the following limits:

- 2048 kbits \pm 50ppm
- 8448 kbits \pm 30ppm
- 34368 kbits \pm 20ppm

The HP 3784A can be used to verify that network equipment can tolerate offsets from the standard rates within the above limits.

In this example the transmitter clock frequency at 34.368 Mbit/s is offset by 20 ppm and the bit error result is verified. The offset is then measured at the receiver. The front panel leds should also be monitored to ensure that there is no sync loss.

Procedure

1. Connect TX DATA OUT port to RX TERNARY DATA IN port.
2. Select Page 1 Preset[**PANEL**] and set instrument to its Default Settings.
3. Select Page 2 Tx Setup and set to Offset[+20]ppm and Er Add[**BIT**][**RATE**]-[3].
4. Select Page 4 [**ERROR RESULTS**] and set for Rx[FREQUENCY]Offset.

The Frequency Offset Measurement is displayed whether or not the instrument is gating.

5. Select Page 5 Gating Period and set to Gating[SINGLE].
6. Reselect Page 4 [**ERROR RESULTS**] and press MEASURE **START/STOP** key.

The Bit Error Count result is now displayed alongside the Frequency Offset.

The HP 3784A can also be used to measure the frequency capture range of an input clock recovery circuit.

A PRBS pattern at one of the standard data rates is input to the equipment under test and the output from the equipment is monitored for errors or sync loss. The input data rate is then offset by up to ± 99 ppm until errors or sync loss are seen at the output.

If the test requires the data rate to be offset by more than ± 99 ppm then the Variable Clock should be used.

Note: Before using the HP 3784A to measure frequency offset outside the the ± 99 ppm range, you should check the instrument back-to-back capture range.

AIS Pattern Generation and Detection

The HP 3784A can be used to generate an AIS or "all ones" test pattern. The WORD pattern on Page 2 Tx Setup is set to all ones.

This is then used to check the operation of AIS alarms which are built into the network to help locate problems.

Storing and Recalling Measurement Configurations

When you have set up the HP 3784A to make a measurement, you can store the complete configuration in internal non-volatile memory so that it can be used again later. This reduces test setup time and simplifies instrument operation and is particularly useful when a number of different measurements are to be performed repeatedly or when the instrument is to be used out in the field.

Up to 5 complete measurement configurations can be stored to be recalled on demand with a single key stroke. You store and recall configurations on Page 1 Preset [PANEL]. Panels 1 to 5 are used for storing your own measurement configurations, Preset Panel 0 is in ROM and contains a set of default values which you cannot change.

You may find that you want to store some of the measurement configurations given in the measurement examples on the following pages. The following procedure shows you how to store a measurement configuration in Preset Panel 4, and then recall it.

Procedure

This example shows you how to store the current measurement configuration in Preset Panel 4, and then recall it.

To Store Configuration in Preset Panel

1. Select Page 1 Preset Panel. If your instrument is Option 002 you may have to set it to Preset [PANEL].
2. Set the Function to [SAVE IN] and Panel Memory to [4].

```
1 Preset [PANEL]
Function [ SAVE IN ] Panel Memory [4]
Select desired function & press EXEC.
Keyboard lock [OFF]
```

3. Press the  key. The display will show as follows:

```
1 Preset [PANEL]
Function [RECALL FROM] Panel Memory [4]
Saved front panel into memory
Keyboard lock [OFF]
```

To Recall Set-up from Panel Memory

1. Select Page 1 Preset Panel.
2. Set the Function to [RECALL FROM] and Panel Memory to [4].

3. Press the **EXEC** key. The display will blank momentarily then show as follows:

```
1 Preset [PANEL]
Function [RECALL FROM ] Panel Memory [4]
Select desired function & press EXEC.
Keyboard Lock [OFF]
```

The HP 3784A has now been set to the configuration which was stored earlier in Preset Panel 4.

Jitter Measurements - Option 002

Timing Jitter is an impairment inherent to all digital transmission systems. If it is left uncontrolled, it can cause an increase in the number of errors within a system and result in a degradation of the quality of service provided.

The HP 3784A Option 002 allows you to make jitter measurements to enable you control the levels of jitter in your equipment.

There are two main sources of jitter in digital transmission networks. These are firstly, electronic components used in equipment design and secondly, some aspects of regenerator and digital multiplexer design which cause jitter to be generated or accumulate. Jitter tends to be either dependent on the pattern content of the data, or random and pattern independent. The pattern dependent sources cause jitter to accumulate on the digital signal as it passes along the transmission system and these are therefore more troublesome.

Jitter caused by electronic components is usually of low amplitude and not a problem. It is the jitter caused by Digital Regenerators which cause the major problem in the networks. Any jitter on the recovered clock affects the data stream in two ways. Firstly, errors may be made in the decision process due to displacement of the sampling position from the centre of the data pulse. Secondly, any jitter present on the input data will be present on the recovered clock and hence on the regenerated data which is transmitted down the line. This is how jitter accumulates through a series of regenerators.

Practical Jitter Measurements

There are three basic types of jitter measurements you can perform, Output Jitter, Jitter Tolerance and Jitter Transfer measurements. Most jitter measurements are made during circuit development, field trials and manufacture test, since good jitter performance is mainly dependent on the design of equipment. Occasionally it will also be necessary to make measurements at equipment interfaces in an operational digital network to identify jitter as a source of errors or of poor slip performance.

CCITT Recommendation G.823 deals with the control of jitter and wander within digital networks which are based on the 2048 kbit/s digital hierarchy.

Output Jitter Measurement

The Output Jitter Measurement is made on data at the output of the equipment under test. It can be either an in-service measurement made on live traffic or an out-of-service measurement where a jitter-free data pattern is applied to the equipment input and any output jitter is measured from the equipment output. This out-of-service measurement can be made on binary or coded ternary data depending on the equipment interface, and is most often carried out during development and manufacture test.

Intrinsic Output Jitter or IOJ is the low amplitude jitter generated internally by digital transmission equipment.

Maximum Output Jitter or MOJ is the level of jitter measured at any point in the network.

Jitter Transfer Function

Some proportion of the jitter present at a system input port is transferred to the output port. The jitter transfer measurement is made at a number of jitter frequencies, and the jitter transfer function (J.T.F.) is plotted to give an indication of the gain or attenuation of jitter across an equipment over a range of jitter frequencies.

$$\text{J.T.F.} = 20 \log_{10} \frac{\text{OUTPUT JITTER}}{\text{INPUT JITTER}}$$

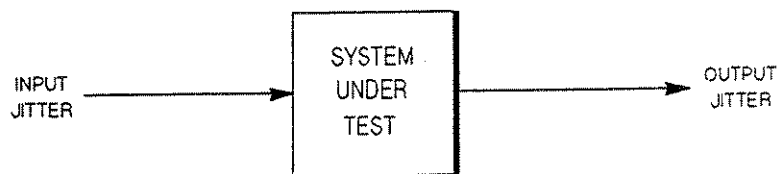

Jitter Tolerance Measurement

The Jitter Tolerance Measurement is used to determine how sensitive equipment is to timing jitter on the input data. A jitter modulated test signal is applied to the equipment input and the output is monitored for bit and code errors.

There are two types of test you can perform. The first is a simple Pass/Fail test where jitter at a specified frequency and amplitude is applied to the equipment input. If there are no errors produced at the equipment output then the equipment is said to pass the test. In the second type of test, the level of jitter at the equipment input is increased until errors are first produced at the output. This level is taken as the Maximum Input Jitter Tolerance or MIJT. To obtain a plot of MIJT, the measurement is repeated at a number of jitter frequencies across a range.

The recommended jitter tolerance of network equipment is described by CCITT in Rec. G.823 in the form of Jitter Tolerance Masks. For each data rate, the Maximum Input Jitter Tolerance - MIJT - is specified across a jitter frequency range.

HP 3784A Jitter Generation and Measurements

Introduction

The HP 3784A can be used to measure jitter performance up to and beyond CCITT Recommendation G.823. You can make Output Jitter, Jitter Tolerance and Jitter Transfer Function measurements manually, and measure two important system parameters, the Maximum Input Jitter Tolerance and the Jitter Transfer Function, automatically.

Measurements can be made on either a ternary data input signal or on a binary clock input signal, and results can be logged to an external printer.

NOTE

If your HP 3784A is Option 002, but jitter generation and measurement is not shown on Page 4, select Page 12 Instrument Type and select [OPTION 002] or select Page 1 Preset[PANEL] and set the instrument to its Default Settings, to switch the jitter capability on again.

Jitter Generation

Jitter may be added to any of the internally generated data patterns at 2, 8 or 34 Mbit/s, or to a signal applied in the THRUDATA mode.

THRUDATA Mode

THRUDATA Mode is used to add jitter to a data stream. The data stream, at one of the nominal bit rates, 2, 8 or 34 Mbit/s, is input to the HP 3784A receiver and output from the transmitter. It is jitter modulated according to the setup on Page 4 [JITTER TOLERANCE] or [JITTER TRANSFER], without any change to the pattern, coding or format.

THRUDATA MODE can be used with either binary or ternary data. With binary data, the HP 3784A receiver must also be supplied with the corresponding clock signal.

To select THRUDATA MODE, select Page 2 Tx Setup and set the Pattern to [THRUDATA].

One application of THRUDATA MODE is in demultiplexer jitter tolerance testing, where jitter is added to the data at the multiplexer output and looped back through the demultiplexer as shown in Figure 3-2. The output from the demultiplexer is monitored for errors.

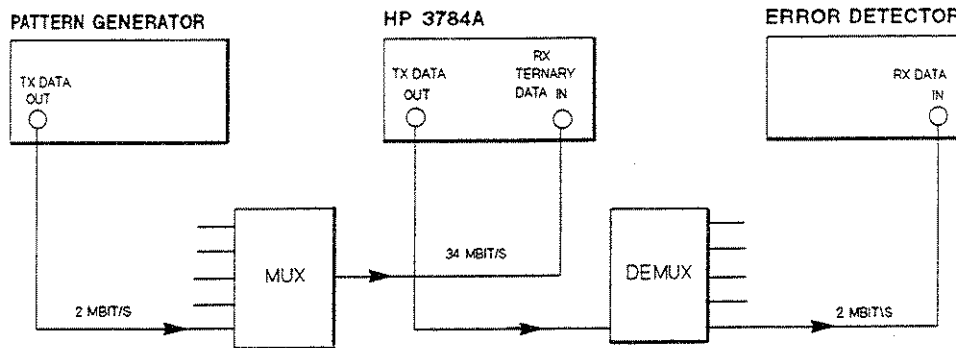

Figure 3-2 Demux Jitter Tolerance Setup.

Transmitter Jitter Modulation

The transmitter output signal is jitter modulated by one of several methods selected on Page 4 [JITTER TOLERANCE] or Page 4 [JITTER TRANSFER FN]. The Modulation field allows the choice of [INTERNAL], [SWEPT MASK], [SPOT MASK] and [EXTERNAL]. These are all explained below.

Internal Modulation

Internal Modulation allows you to set the jitter amplitude and frequency independently. You position the CURSOR on the "Amplitude" and "Frequency" fields and set the values you require within the limits of the instrument jitter modulator.

Swept and Spot Mask Modulation

The HP 3784A OPT 002 can be used to jitter modulate the transmitter output as specified by either the appropriate CCITT Rec. G.823 mask or by a user-programmed jitter mask.

The jitter amplitude is set according to the values on a given mask as the frequency is changed. The masks can be swept automatically up and down or you can select various "spot" frequencies on the mask and the amplitude is set to the corresponding value.

Standard [STD] Masks

There are five hard-programmed CCITT Rec.G.823 standard tolerance masks covering the three jittered bit rates, 2, 8 and 34 Mbit/s, with high and low Q factor systems catered for at 2 Mb/s and 8 Mb/s data rates.

The masks can be swept transient free automatically.

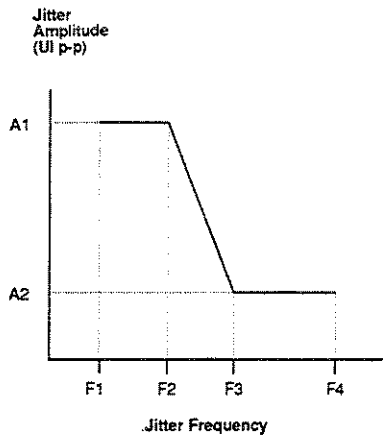

Nominal Bit Rate (kb/s)	704	2048	8448	34368
A1 (UI p-p)	—	1.5	1.5	1.5
A2 (UI p-p)	—	0.2	0.2	0.15
F1 (Hz)	—	20	20	100
F2 (kHz)	—	2.4 (0.093)	10.7 (0.4)	1.0
F3 (kHz)	—	18 (0.7)	80 (3)	10
F4 (kHz)	—	100	400	800

The values shown in () apply when the high Q filter is selected.

Programmable [PROG] Masks

You can program your own jitter masks into the HP 3784A. These must lie within specified frequency and amplitude limits and may have between two and six break points. Interpolation between break points is linear.

To program a mask, select Page 1 Preset [MASK] [PROG] and select the number of mask points you want to program. Now, using the CURSOR POSITION keys and the UPDATE and keys, set the points to the chosen values.

```
1 Preset [MASK] [PROG] 2MHz Points [2]
[10.0Hz] [ 0.80]UI ▶ [50.0kHz] [ 0.80]UI
```

External Modulation

Selecting External Modulation on Page 4 [JITTER TRANSFER FN] or [JITTER TOLERANCE] allows you to modulate the transmitter output with an external signal applied to the EXT MODULATION IN port. This signal must lie within the specified bounds of the input port.

Jitter Measurement

Measurement Filters

In the HP 3784A receiver there are filters which pre-shape the demodulated jitter signal before jitter amplitude measurement.

You can switch the filters off, or select one of the following:

- Low Pass
- High Pass 1 + Low Pass
- High Pass 2 + Low Pass

This selection is made on Page 4 [OUTPUT JITTER] or [JITTER TRANSFER FN].

Intrinsic Jitter Performance

For optimum intrinsic jitter performance, the transmitter and receiver should be used either at identical bit rates, i.e. from the same source, or at rates differing by more than 1%.

Jitter Measurement Display Update Rates

The HP 3784A receiver has a choice of three jitter measurement update rates to ensure that the displayed result is accurate to within the limits of instrument specification.

If you want to measure jitter at frequencies above or equal to 10 Hz on the ternary data or binary clock signal, the jitter display rate on Page 3 Rx Setup should be set to FAST.

For measuring jitter at minimum frequencies between 1 and 10 Hz, the display rate should be set to MEDIUM. For measuring jitter at minimum frequencies below 1 Hz, the display rate should be set to SLOW.

Note: If the receiver is set to Range 1, and you are measuring jitter at frequencies below 20 Hz, a reference clock must be supplied to receiver jitter measurement circuitry via the TX REF IN/OUT port from an external source. In the situation where the HP 3784A transmitter is used to generate the test pattern, this reference clock should be taken from the TX REF CLOCK OUT port.

If the receiver is set to Range 10, a reference clock must be supplied for measuring jitter at any frequency below 10 Hz.

In both cases, using a reference clock from an external source, the measurement range can be extended down to 0.1 Hz.

Jitter Measurements on a Binary Clock Signal

If the HP 3784A receiver jitter measurement circuitry is supplied with a reference clock from an external source, jitter can be measured on any binary clock signal in the range 2.048 to 34.368 Mbit/s. The reference clock is supplied to the receiver via the rear panel RX REF CLOCK IN/OUT port. The reference clock for jitter measurement and the clock signal on which the jitter is to be measured must originate from the same source. If the HP 3784A transmitter is used to generate the binary clock and data, the reference clock should be taken from the rear panel TX REF CLOCK OUT port.

To make a back-to-back jitter transfer or output jitter measurement where the receiver is supplied with a reference clock, the equipment should be connected as shown below.

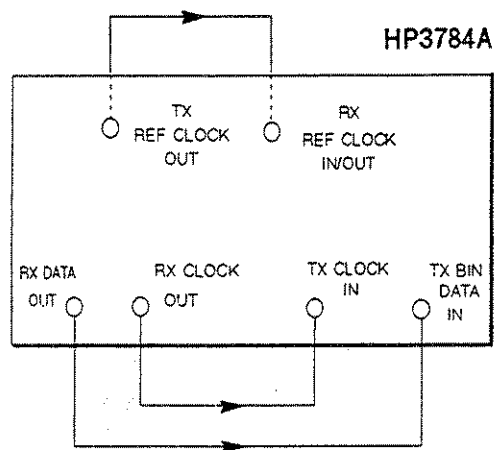

Figure 3-3 Jitter Measurements on a Binary Clock.

HP 3784A Output Jitter Measurement

The HP 3784A can be used both out-of-service and in-service to measure the jitter on the output signal from a system under test. The measurement can be made on coded ternary data or on the binary clock signal.

Out-of-Service Measurement

In the following procedure, a jitter-free signal is applied to the system input, as in Figure 3-4, and the jitter is measured from the system output. First the low level of HP 3784A back-to-back intrinsic jitter is measured.

Procedure

1. Connect the HP 3784A TX DATA OUT port to the RX TERNARY DATA IN port.
2. Select HP 3784A Page 1 Preset[**PANEL**] and set instrument to its Default Settings, by recalling preset panel [0].
3. Select Page 2 Tx Setup and set the appropriate interface, data rate and pattern for making a measurement on your system under test.
4. Select Page 4 [**OUTPUT JITTER**] and select measurement filters if required. Observe the measured peak-to-peak level of intrinsic jitter.

```
4 [ OUTPUT JITTER ] Rx Range [10]
  Elapsed time..... 00d 00h 00m 00s
Rx Jitter Hit [COUNT].....
Rx Jitter [ PK-PK ] [OFF]..... UI
```

5. Connect the HP 3784A TX DATA OUT port to the system input port. Connect the output from the system to the HP 3784A RX TERNARY DATA IN port. See Figure 3-4 below.

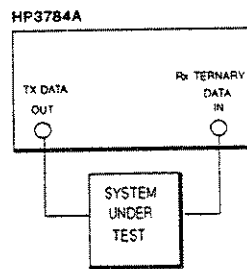

Figure 3-4 Equipment Setup

6. Observe the measured level of Output Jitter from the system under test.

A spectrum analysis of the output jitter may be observed by connecting a Spectrum Analyzer (for example HP 3585A) to the HP 3784A rear panel DEMOD JITTER OUT port.

To measure the rms jitter amplitude, an RMS Voltmeter (for example HP 3478A) may be connected to the DEMOD JITTER OUT port.

In-Service Output Jitter Measurements

The HP 3784A can be used to make in-service jitter measurements on live data. There is a monitor or "MON" mode available which provides additional gain at the receiver input to allow you to make measurements at the high impedance protected monitor points in distribution frames or other digital equipment.

The jitter measurement results can be logged continuously or selectively to an external printer, and can be related to the code error measurement results. Selective logging can be triggered by one of the following:

- the occurrence of a Jitter Hit
- when the maximum jitter peak in the measurement interval exceeds a specified threshold.
- on the occurrence of a code error.

For information on data logging refer to Section 5.

Procedure

Connect the data signal at one of the nominal bit rates, 2, 8 or 34 Mbit/s to the HP 3784A receiver RX TERNARY DATA IN port.

Select Page 3 Rx **Setup** and set the data rate to the correct value and select either [75 MON] or [120MON].

On Page 7 **Data Logging**, select the logging parameters of your choice and ensure that the gating period is set accordingly.

NOTE

When you are making out of service measurements on live data, the SYNC LOSS and BIT ERRORS leds will be on. This is due to the pattern detector being unable to lock onto the incoming random data and does not affect the Code Error or Jitter Measurement.

Jitter Analysis Measurement

In addition to measuring the instantaneous level of jitter on the ternary data or binary clock signal, the HP 3784A receiver can analyze the time-varying jitter content over a measurement gating period and display the results as Jitter Hit Count, Jitter Hit Intervals, Jitter Hit-Free Intervals and Maximum Pk-Pk Jitter Amplitude. A "Hit" is counted each time the jitter amplitude exceeds a threshold level set by the user.

All the jitter results can be viewed on Page 4 [OUTPUT JITTER] or [JITTER TRANSFER FN]. The HITS led on the instrument front panel illuminates each time a jitter hit occurs. If you are logging measurement results to an external printer, you can choose to trigger logging on the occurrence of a Hit Interval.

HP 3784A Jitter Tolerance Measurements

You can use the HP 3784A in one of four different ways to make a jitter tolerance measurement, depending on how much time you want to spend making the measurement and the degree to which you wish to verify your system performance.

Jitter Tolerance Measurement at a Number of Jitter Points

Using this method you can quickly verify the jitter tolerance of your equipment at a few critical points.

Select Page 4 [JITTER TOLERANCE] and set the Modulation to [INTERNAL]. Set the jitter frequency and jitter amplitude independently to your chosen values.

Jitter Tolerance Measurement at a Number of "Spots" on the Jitter Mask

This test enables you to do a quick jitter tolerance check on the equipment under test at a number of points on the CCITT or user-programmed jitter mask. It is a quicker test than the Swept Mask test, but does not verify the performance at all points across the jitter frequency range.

Select Page 4 [JITTER TOLERANCE] and set the modulation to [SPOT MASK][STD] or [PROG]. Now set the Jitter Frequency to several different values within the range of the mask and the jitter amplitude will be set automatically.

Jitter Tolerance Measurement using Swept Mask Modulation

This test verifies the equipment jitter tolerance at values on the CCITT mask or your own programmed mask, across the complete jitter frequency range.

Select Page 4 [JITTER TOLERANCE] and this time set the modulation to [SWEPT MASK][STD] or [PROG]. The transmitter output is now jitter modulated according to the values on the CCITT or user-programmed mask, as the mask is swept continuously up and down.

If a printer is connected, you can set it to log on the occurrence of bit errors and print the corresponding transmitter jitter frequency. This is done by selecting Page 7 Data Log and setting it as follows:

```
7 Data Log. Logging [ TEXT ]
Set-up [REAL-TIME] Log [PAGE 4 RESULTS]
Error [BIT RESULT ] Jitter [TX JIT FREQ]
Trigger [BIT ERR SECS] Squelch [OFF]
```

Automatic Jitter Tolerance Plotting

The HP 3784A enables you to measure the absolute jitter tolerance of you equipment automatically across the frequency range specified for each data rate by CCITT Recommendation G.823, and plot the results to an external printer. The measurement results and CCITT or user-programmed jitter tolerance mask are plotted on the same axes to allow you to compare the two graphs.

The automatic tolerance plot takes between about 8 minutes and 20 minutes to complete depending on the data rate and produces a complete picture of the equipment jitter tolerance performance across the frequency range.

How to Make a Jitter Tolerance Measurement

This example demonstrates how to make jitter tolerance measurements using "Spot" Mask modulation and then using "Swept" Mask modulation.

Spot Mask Modulation

In steps 1-7, the system tolerance to jitter is verified at four points on the CCITT Jitter Tolerance Mask.

1. Connect the equipment as shown in Figure 3-5.

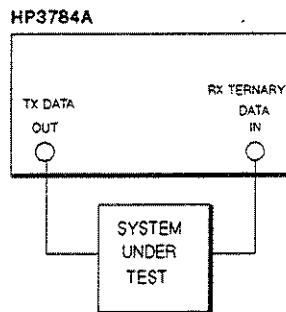

Figure 3-5 Equipment Setup

2. Select HP 3784A Page 2 Tx Setup and set the interface, clock rate and pattern to be compatible with your system under test.
3. Select Page 3 Rx Setup and set to either [As Tx] or [MAN] with the correct settings, to match the transmitter.
4. Select Page 4 [JITTER TOLERANCE] and set to Modulation[SPOT MASK][STD].
5. Press the MEASURE **START/STOP** key.
6. Now set the Jitter Frequency to each of the following values in turn and, at each frequency, verify that both the BIT ERRORS and CODE ERRORS leds are off, indicating that there are no errors at the equipment output.

[100 Hz] [1.00 KHz] [10.0 KHz] [100. KHz]

7. Press the MEASURE **START/STOP** key to terminate the measurement.

Swept Mask Modulation

The following steps allow you to verify the system jitter tolerance across the complete CCITT jitter tolerance mask.

Jitter as specified by one of the hard-programmed or user-programmed masks is added to the data input to a system under test. The frequency and amplitude of the jitter is changed as the mask is swept up and down. The system output is monitored for errors. When an error occurs, the HP 3784A detects it and logs the corresponding values of jitter frequency and amplitude to the external printer. Logging is triggered only by the occurrence of a Bit Error.

8. Connect a Printer to the RS-232-C or HP-IB port.
9. Select Page 8 Remote Port and set to [RS232].
10. Select Page 9 Logging Port and set to either [RS232] or [HPIB] depending on the type of printer you have connected.
11. Select Page 5 Gating Period and select either a [MANUAL] or [SINGLE] gating period.
12. Select Page 7 Logging and set to the following:

```
7 Data Log. Logging [ TEXT ]
Set-up [REAL-TIME] Log [PAGE 4 RESULTS]
Error [BIT RESULT ] Jitter [TX JIT FREQ]
Trigger [BIT ERR SECS] Squelch [OFF]
```

13. Select Page 4 [JITTER TOLERANCE] and set to Modulation [SWEPT MASK].
14. Press MEASURE key.

The printer will log any instances of bit errors and the corresponding jitter frequency. If there are no bit errors, the system jitter tolerance conforms to the minimum standard specified by CCITT.

How to Make an Automatic Jitter Tolerance Measurement

The following procedure demonstrates how to carry out an Automatic Jitter Tolerance measurement and plot the results to an external printer.

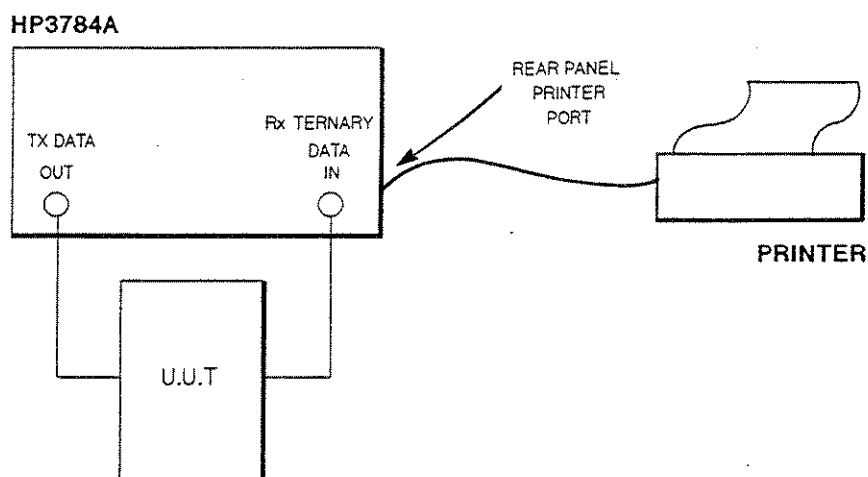

Figure 3-6 Automatic Jitter Tolerance Setup

The automatic routine measures the jitter tolerance at a number of jitter frequencies in a range specified

for the appropriate data rate by CCITT Rec G.823. The equipment setup is shown in Figure 3-6. The signal from the HP 3784A transmitter is input to the system under test, and the signal from the system output is monitored for bit errors. The jitter frequency is set at the lower end of the CCITT range and the jitter amplitude is increased until errors are detected at the output of the system under test. The jitter amplitude is then stepped back for the "no-errors" condition and this value is taken as the Maximum Input Jitter Tolerance, or MIJT, and plotted to the external printer on the jitter tolerance graph.

The jitter amplitude level is then set low again and the jitter frequency is increased by 20 % to the next point in the range. The jitter amplitude is again increased until errors are detected at the system output. The routine is repeated across the frequency range.

The hard-programmed CCITT mask or the user-programmed mask is plotted on the same graph, to allow you to compare your measurement results with the recommended results. You must select the type of mask you want plotted before you start the measurement.

HP 3784A Jitter Transfer Function Measurement

With the HP 3784A Option 002 there are two ways to plot the Jitter Transfer Function of a system under test. The first is to select Page 4 [JITTER TRANSFER FN], set the transmitter jitter amplitude and frequency values independently and calculate the gain from the measured and transmitted jitter amplitudes in the receiver. The second method is to select Page 4 [AUTO TRANSFER FN] and run the automatic routines to plot the function automatically across the jitter frequency range specified in CCITT Rec. G.823 for your selected data rate. The automatic measurement has the advantage that the pre-measurement calibration routine cancels out errors in the transmitter setup and receiver measurement.

When analyzing the jitter transfer function plots for multiplexer-demultiplexer pairs, there are two characteristics to look for. The first is the tendency for peaking above the 0 dB line. This is important because it indicates the equipment could amplify any jitter at its input and pass it on through the network. The second characteristic to look at is the roll-off. The position of this indicates the amount of jitter created by the demultiplexing operations of frame bit removal destuffing and retiming. It is desirable for the roll-off to start well within the CCITT mask. At higher frequencies, the roll-off should continue but it may be masked by various "waiting-time" jitter peaks. These peaks are sharply defined and are due to low frequency components of jitter being generated through the mux-demux pairs when jitter is input to them at a much higher frequency.

How To Make A Jitter Transfer Function Measurement

This measurement example demonstrates a HP 3784A Jitter Transfer Function Measurement using Internal Jitter Modulation, setting the jitter frequency and amplitude independently.

Procedure

1. First, connect the HP 3784A back-to-back, by connecting the TX DATA OUT port to the RX TERNARY DATA IN port.
2. Select Page 1 Preset[PANEL] and set the instrument to its Default Settings by recalling Panel Memory 0.
3. Select Page 4 [JITTER TRANSFER FN] and set to the following:

```
4 [JITTER TRANSFER FN]    Rx Range [10]
Modulation [ INTERNAL ]..... [1.00KHz]
Tx Jitter Amplitude P-P..... [1.00]UI
Rx Jitter [ PK-PK ] [OFF].....      UI
```

4. Note the Rx Jitter [PK-PK] reading. This is the back-to-back value.
5. Now connect the equipment as shown below in Figure 3-8.

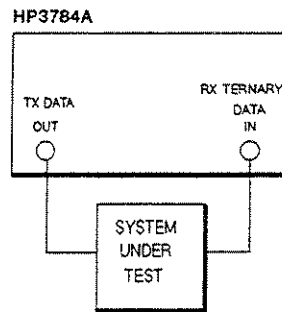

Figure 3-8 Equipment Setup

6. The peak-to-peak jitter amplitude value is displayed on Page 4.
7. Position the cursor on the [PK-PK] field and press the UPDATE key to change it to [NEG PK] and then [POS PK]. Verify the value is 0.5 UI for each.

How to Make an Automatic Transfer Function Measurement

The following procedure demonstrates how to make an Automatic Jitter Transfer Function Measurement.

There are two stages to the measurement. The first stage calibrates the level of jitter on the HP 3784A transmitter output. For each jitter frequency in the range, the jitter amplitude is measured and recorded internally. Nothing is plotted at this stage.

The second stage, the plot routine, sets the jitter on the transmitter output to the same values as in the calibration routine. This signal is input to the system under test. The jitter gain or transfer is calculated as the ratio of the jitter output from the system under test to the jitter amplitude input to the system under test.

Procedure

1. Connect the HP 3784A TX DATA OUT port to the RX TERNARY DATA IN port.
2. Select HP 3784A Page 1 Preset Panel and set the instrument to its Default Settings.
3. Select Page 2 Tx Setup and set to Clock[STD RATE][2 MHz]. and Pattern[PRBS][15].
4. Select Page 4 [AUTO JIT TRANSFER FN] and set to the following:

```

4 [AUTO JIT TRANSFR FN]      Mode [CAL ]
Calibrate with Tx Data Out coupled to Rx
Tern Data In for ternary signals.
Then press EXEC to start.

```

5. Press the **EXEC** key. Wait for the Calibration routine to complete. At this stage nothing is plotted.
6. Now set Page 4 [AUTO JIT TRANSFER FN] and set to the following.

```

4 [AUTO JIT TRANSFR FN]      Mode [PLOT]
Use CALibrate mode first then select the
Y axis Scale [10]dB.  Connect THINKJET.
Then press EXEC to start.

```

7. Press the **EXEC** key again. This time wait for the automatic plot routine complete.

Alternate Word Pattern Generation

One application of the HP 3784A Option 002 Alternate Word generation capability is in the measurement of the amplitude/phase conversion response of a chain of regenerators to changes in pattern density. An alternating word pattern is input to the first regenerator in the chain and the signal from the last regenerator is input to the receiver RX TERNARY DATA IN port. When the input pattern is a low density pattern, that is it has few "ones", the regenerator clock recovery circuits free-run during the runs of zeros at the input at a rate tending to the resonant frequency. If this is not exactly the same as the data frequency, there will be an abrupt change in phase when the density of the patterns increases and the clock recovery circuit is forced to run at the "driven" rate.

To measure this amplitude/phase conversion response, the HP 3784A is used in the following setup:

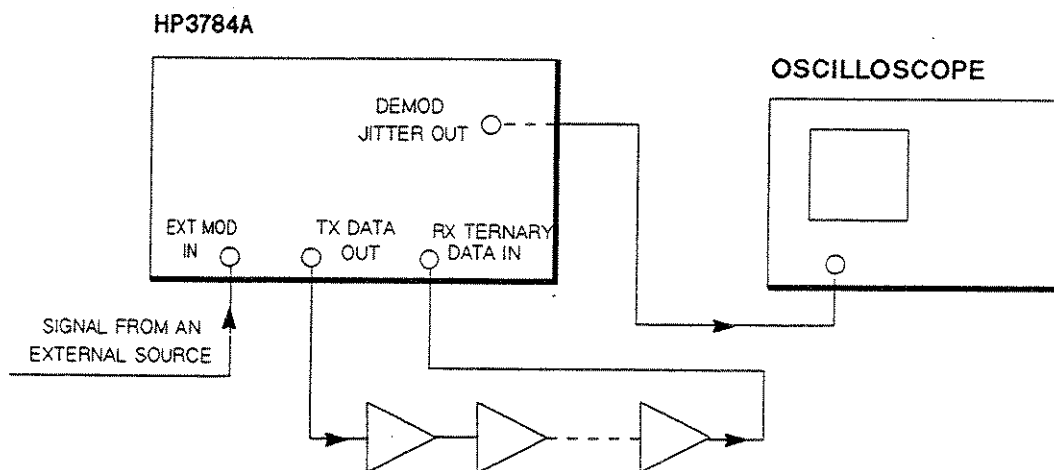

Figure 3-9 Amplitude/Phase Conversion Setup.

An Alternating Word pattern from the HP 3784A transmitter is input to the chain of regenerators. The signal from the last regenerator in the chain is input to the HP 3784A receiver. WORD A is set to 1000000 and WORD B is set to 11111111. The switching signal can be applied externally to the EXT MODULATION IN port or taken from the internal source. The signal displayed on the oscilloscope indicates the response of the regenerator chain to changes in pattern density. The "frequency" of this signal is the same as the alternating frequency.

HP 3784A OPT 006 - 64 kbit/s Measurements

Introduction

With HP 3784A OPTION 006 you can make bit error measurements at 64 kbit/s co-directional interfaces in addition to the measurements at binary and ternary interfaces offered in the standard instrument. The error analysis at 64 kbit/s is based on Error Count rather than Error Ratio results.

At a codirectional interface, each bit of 64 kbit/s data is coded into a block of four bits in the following way: A binary "1" is transmitted as an NRZ "1100" pattern and a binary "0" is transmitted as a "1010" pattern. The binary signal is converted to a ternary signal by alternating the polarity of consecutive blocks. The output data symbol rate is therefore at 256 kbit/s.

An 8 KHz timing signal can be introduced to mark the eighth bit of each octet in the 64 kbit/s data stream. This is called octet timing and introduces a violation block into the ternary signal. The HP 3784A offers the choice of switching the octet timing on or off. With Octet Timing selected, a 1000 0000 WORD pattern would be transmitted as shown below:

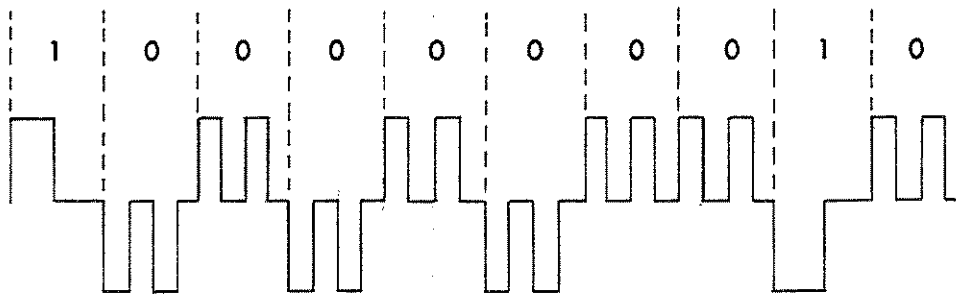

Figure 3-10 Codirectional Coding with Octet Timing.

To select the codirectional interface and set octet timing, select Page 2 Tx Setup and first set the Clock to [STD RATE][64 kHz]. Then set the Data field to [CODIR][+OCT]. If you set this field to [-OCT], the octet timing is switched off.

An 8-bit Word pattern can be used to simulate the PCM coding of each sample of an analog waveform. In this case, octet timing would be switched on to mark each group of eight bits. Different word patterns can be used to test the system for pattern-dependent error sources.

The frequency offset and error add can be set as you choose.

```
2 Tx Setup.   Data Out [ CO-DIR ] [+OCT]
Clock [STD] [64.00]KHz   Offset [ +0]ppm
Pattern [WORD] [ 8]Bit [10001100   ]
Er Add (bit) [OFF ]      Clock Out [NORM]
```

Select Page 3 Rx Setup and set to either [AS TX] or as follows:

```
3 Rx Setup.      Data In [CO-DIR] [+OCT]
                  Clock Rate [64 KHz]
Pattern [WORD] [ 8]Bit [10001100 ]
Jitter Display Rate [FAST]
```

Practical Measurements at 64 kbit/s Codirectional Interfaces

When making measurements at 64 kbit/s interfaces on a system under test, there are three different methods of deriving the timing for the HP 3784A transmitter:

1. The HP 3784A transmitter clock is derived from its own internal source. This is set at the same nominal rate as the clock in the system under test, but is not in phase with it. The timing for the HP 3784A receiver is derived from the incoming data signal. The timing in this test setup is "plesiochronous".
2. The transmitter timing is derived from the recovered clock at the receiver RX TERNARY DATA IN port. This is called "looped" timing and means that the HP 3784A and system under test are operating synchronously.
3. The HP 3784A transmitter timing is derived directly from the system clock applied to the TX CLOCK IN port. This again means that the HP 3784A and system under test are operating synchronously.

CCITT Rec O.152 recommends a $2^{11}-1$ PRBS test pattern for testing at 64 kbit/s.

Plesiochronous Timing

This procedure demonstrates the test setup for making a 64 kbit/s measurement on a system with the HP 3784A transmitter timing derived from its own internal source.

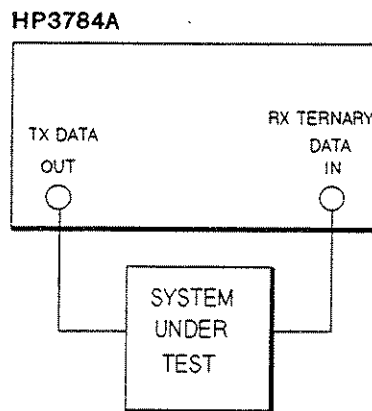

Figure 3-11 Equipment Setup

Procedure

1. Connect the equipment as shown in Figure 3-11.
2. Select Page 1 Preset[**PANEL**] and set the instrument to its Default Settings by recalling preset panel [0].
3. Select Page 2 Tx Setup and set to the following:

```
2 Tx Setup.   Data Out [ CO-DIR ] [+OCT]
Clock [STD RATE] [64]KHz Offset [ +0]ppm
Pattern [WORD] [ 8]Bit [10111010   ]
Er Add (bit) [MAN ]      Clock Out [NORM]
```

4. Select Page 3 Rx Setup and set to the following:

```
3 Rx Setup.   [ AS TX ]

Jitter Display Rate [FAST]
```

5. Select Page 4 [**ERROR RESULTS**].

Now you are ready to make a Bit Error Measurement.

6. Press the MEASURE **START/STOP** key.

To obtain Error Analysis results, select Page 4 [**ERROR ANALYSIS**].

Synchronous Timing - Looped

In this measurement example the equipment is connected as shown in Figure 3-12. The timing for the HP 3784A transmitter is derived from the receiver recovered clock.

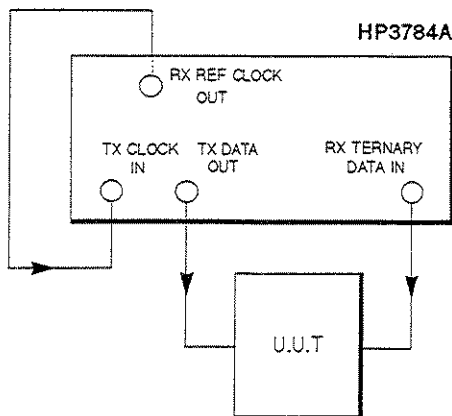

Figure 3-12 Equipment Setup.

Procedure

1. Connect the equipment as shown in Figure 3-12.
2. Select Page 1 Preset[**PANEL**] and set the instrument to its Default Settings by recalling Panel Memory 0.
3. Select Page 10 Rear Panel Ports and set Selectable Port to [**RX CLOCK OUT**].
4. Select Page 2 Tx Setup and set to the following:

```
2 Tx Setup.      Data Out [CO-DIR] [-OCT]
Clock [ EXT ].....0Hz  Offset [ +0]ppm
Pattern [PRBS]-[11]      Zero Sub [000]
Er Add [BIT ] [OFF ]      Clock Out [NORM]
```

5. Select Page 3 Rx Setup and set to the following:

```
3 Rx Setup.      Data In [ CO-DIR] [-OCT]
                  Clock Rate [64 kHz]
Pattern [AS TX]      Zero Sub [000]
Jitter Display Rate [FAST]
```

6. Select Page 4 [**ERROR RESULTS**].

Now you are ready to make a Bit Error Measurement.

To obtain Error Analysis results, select Page 4 [**ERROR ANALYSIS**].

Synchronous Timing - External Clock

A clock from the system under test is used as the external source for timing of the HP 3784A Transmitter output data. The test setup is shown in Figure 3-13.

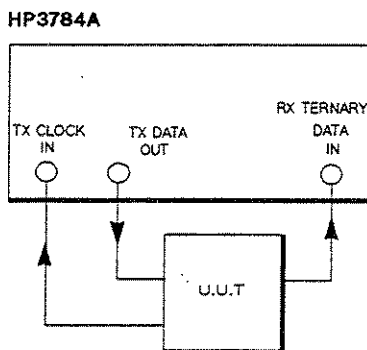

Figure 3-13 Equipment Setup.

Procedure

1. Connect the equipment as shown in Figure 3-13.
2. Select Page 1 Preset [PANEL] and set the instrument to its Default Settings.
3. Select Page 2 Tx Setup and set to the following:

```
2 Tx Setup.   Data Out [CO-DIR] [-OCT]
Clock [ EXT ].....0Hz   Offset [ +0]ppm
Pattern [PRBS]-[11]      Zero Sub [000]
Er Add [BIT ] [MAN ]     Clock Out [NORM]
```

4. Select Page 3 Rx Setup and set to the following:

```
3 Rx Setup.   Data In [ CO-DIR] [-OCT]
               Clock Rate [64 kHz]
Pattern [AS TX]      Zero Sub [000]
Jitter Display Rate [FAST]
```

5. Select Page 4 [ERROR ANALYSIS].

You are now ready to make bit error measurements.

To obtain Error Analysis results, select Page 4 [ERROR ANALYSIS].



Introduction

This section contains functional descriptions of each of the pages listed in the HP 3784A Indexes. Each description includes an explanation of user-selectable functions/parameters, and where necessary practical examples of how to setup/perform various functions. For details on how to use the front panel keys to select pages or items within a page refer to Section 2 "Getting Started".

Need Help?

An important feature of the HP 3784A is the helpful information presented to the user when the front panel **HELP** key is pressed. The information displayed refers to the Page displayed prior to the **HELP** key being pressed. The Help Pages given in this section are placed adjacent to the page to which they refer.

Store and Recall Measurement Configurations (Page 1)

For some users, many different measurement setups and tests may be required. The ability to remember these configurations and then recall them on demand is highly desirable, as it simplifies instrument operation and saves valuable test time. The HP 3784A offers this feature by providing nonvolatile memory (NVM) with battery back-up, allowing up to 5 measurement configurations to be stored in memory and recalled on demand. This function is implemented on Page 1 Preset Panel.

Measurement configurations are stored in Preset Panels 1 to 5 inclusive. Panel Memory 0 contains a set of default values which cannot be changed by the user (see Page 2-20 for a list of default settings). If the HP 3784A is powered down or power failure occurs, instrument configuration and results are retained in memory, and returned when the HP 3784A is next powered-up. If the nonvolatile RAM memory is lost, eg by the removal or failure of the battery, the instrument configuration will be returned to that of Panel Memory 0 at power-up.

```
1 Preset [PANEL]
Function [RECALL FROM] Panel Memory [0]
Select desired function & press EXEC.
Keyboard lock [OFF]
```

```
HELP. Select memory number by using
UPDATE keys then press EXEC. key to
execute desired function. The lock
gives protection to current settings.
```

Function:

[SAVE IN]

Pressing the **EXEC** key saves the current measurement configuration in the Panel Memory selected.

[RECALL FROM]

Pressing the **EXEC** key recalls the measurement configuration from the Panel Memory selected.

Panel Memory

Select a memory location from 0 to 5.

Keyboard Lock

On/Off - protects instrument setup from casual interference.

Jitter Tolerance Standard and Programmable Masks - Option 002 instruments.

The HP 3784A option 002 provides Jitter Generation and Measurement. Jitter measurements and the type of jitter modulation offered, are viewed and selected on Page 4 Measurements. Four types of modulation are offered: [INTERNAL], [EXTERNAL], [SPOT MASK] and [SWEPT MASK]

The [INTERNAL] and [EXTERNAL] choices offer the user complete control of amplitude and frequency.

In [SPOT MASK] and [SWEPT MASK] modes the HP 3784A controls the amplitude so as to conform to values stored in Page 1 Preset [MASK]. The frequency is controlled by the user, in [SPOT MASK].

[SPOT MASK] and [SWEPT MASK] each include the choice of a standard tolerance mask or a user programmable mask; selectable in the [STD] and [PROG] fields on Page 4. Both the standard and programmable masks are displayed on Page 1 Preset [MASK], examples of these, and descriptions of the user selectable fields on these displays is given below.

Standard Tolerance Mask

Five hard programmed jitter masks are provided covering the three jittered rates of 2048kHz, 8448kHz and 34368kHz. For bit rates 2048 and 8448kHz, high and low Q systems are catered for giving two types of [STD] mask for each. The mask displayed relates to the Clock Rate selected on Page 2 Tx Setup.

Standard Tolerance Mask for Transmitter Frequency of 34MHz.

1 Preset [MASK] [STD]	34MHz	Points 4
100.Hz	1.50 UI ▶ 1.00KHz	1.50 UI
10.0KHz	0.15 UI ▶ 800.KHz	0.15UI

HELP. The mask displayed corresponds to the Clock Rate selected on Tx Setup page. Choice of STD or PROG can be made on p1 or at p4 Modulation [XXXX MASK].

Transmitter Frequency.....8MHz
Q Factor.....[HIGH]

1 Preset [MASK] [STD]	8MHz	Points 4
20.0Hz	1.50 UI ▶ 400.Hz	1.50 UI
3.00KHz	0.20 UI ▶ 400.KHz	0.20UI
Q Factor	[HIGH]	

Transmitter Frequency.....8MHz
Q Factor.....[LOW]

```
1 Preset [MASK][STD ] 8MHz Points 4
20.0Hz 1.50 UI ▶ 10.7KHz 1.50 UI
80.0KHz 0.20 UI ▶ 400.kHz 0.20UI
Q Factor [LOW ]
```

Transmitter Frequency.....2MHz
Q Factor.....[HIGH]

```
1 Preset [MASK][STD ] 2MHz Points 4
20.0Hz 1.50 UI ▶ 93.0Hz 1.50 UI
700.Hz 0.20 UI ▶ 100.KHz 0.20UI
Q Factor [HIGH]
```

Transmitter Frequency.....2MHz
Q Factor.....[LOW]

```
1 Preset [MASK][STD ] 2MHz Points 4
20.0Hz 1.50 UI ▶ 2.40KHz 1.50 UI
18.0KHz 0.20 UI ▶ 100.KHz 0.20UI
Q Factor [LOW ]
```

Programmable Tolerance Masks

Programmable Tolerance masks are provided for each of the HP 3784A Transmitter jittered clock rates (2MHz, 8MHz and 34MHz). The HP 3784A Transmitter Clock Rate is selected on Page 2 Tx Setup.

The user can program masks with any number of break points from 2 to 6, an example of a Programmable Tolerance Mask is given below. Interpolation between points is linear when reproduced on a log log plot.

```
1 Preset [MASK][PROG] 34MHz Points [6]
[10.0Hz ] [ 0.80]UI ▶ [400.KHz] [ 0.80]UI
[400.KHz] [ 0.80]UI ▶ [400.KHz] [ 0.80]UI
[400.KHz] [ 0.80]UI ▶ [400.KHz] [ 0.80]UI
```

Points
[2 to 6]

The **Points** field determines the number of break points in the Programmable Tolerance Mask.

Tx Setup (Page 2)

The HP 3784A internal Transmitter is configured on Page 2 Tx Setup, an example of which is given below. The user selectable functions are Data Out, Clock, Offset, Pattern, Er Add, Zero Sub and Clock Out; these are explained in the following paragraphs.

```
2 Tx Setup.   Data Out [ BINARY ] [TTL ]
Clock [STD RATE] [34 MHz] Offset [ +0]ppm
Pattern [PRBS] - [ 9]           Zero Sub [000]
Er Add (bit) [RATE] - [3] Clock Out [NORM]
```

```
HELP. Clock [EXT] or [VAR] gives free
choice of Interface. [STD] gives valid
choice only. Clock Out level is set
at the Data Out [BINARY] [xxx] field
```

Transmitter Interface

The HP 3784A Transmitter Interface is set at the Data Out fields and can be selected from a choice of Binary or Ternary interfaces. The HP 3784A Receiver can be arranged to follow the Transmitter settings if desired.

Data Out:

[BINARY]

When Binary is selected the choice of [ECL] or [TTL] levels (linked with that of the Receiver) is provided; [ECL] into 75 ohms to -2V and [TTL] into 75 ohms to ground.

Ternary Operation
[75 TERM]

75 ohms nominal unbalanced to ground at all four clock rates (704kHz, 2MHz, 8 MHz and 34 MHz).

[120 TERM]

120 ohms nominal balanced selectable for clock rates of 704 kHz and 2048 kHz.

Option 006
[CO-DIR] [+OCT]
[CO-DIR] [-OCT]

For the 64 kBit/s rate a choice of either Binary (ECL or TTL) data interface or co-directional interface is provided.

Clock Generation

Three different modes of clock generation are provided as follows:

A: From an external source [EXT].

B: At the specific rates 704, 2048, 8448 and 34368 kHz plus frequencies offset from those specified by up to ± 99 ppm. Option 006 offers an additional clock at 64kHz. C: At rates from 1kHz to 50MHz (resolution is range dependent) plus frequency offset by up to ± 99 ppm.

Clock
[EXT]

An external clock in the frequency range 1kHz to 50MHz may be input to the HP 3784A Tx **CLOCK IN** port. The frequency of the external clock is displayed on Page 2 Tx **Setup**.

[STD RATE] [704kHz]
Offset [**] ppm.

Provides an internal clock at one of four standard rates (704kHz, 2048kHz, 8448kHz and 34368kHz) which can be offset by up to ± 99 ppm.

[VAR] [2048.0]kHz
Offset [**] ppm.

The internal clock may be varied at rates from 1kHz to 50MHz (resolution is range dependent). The clock rate selected may be offset by up to ± 99 ppm.

Option 006

Option 006 instruments only. Provides an additional internal clock at 64kHz, which can be offset by ± 99 ppm.

[STD RATE] [64kHz]

Pattern

The Pattern fields offer the user the choice of selecting from one of seven different PRBS lengths, an N bit fully programmable word (where N is selectable from 1 to 16) or two fixed length 8 bit fully programmable alternating words (or a THRU DATA mode in option 002).

[PRBS]

Seven different PRBS lengths are offered:
[6], [9], [11], [15], [17], [20] and [23]

Zero Sub

[000]

Up to 999 zeroes may be substituted for the data in the PRBS pattern generated by the HP 3784A. Substitution starts at the first zero in the longest run of zeroes i.e. following the trigger pulse position. Note: For [15] and [23] the trigger pulse position is at the start of the longest run of ones.

Word

[WORD] [N] Bit [****]

An N bit fully programmable word is provided (where N is selectable from 1 to 16).

[ALT WORD]

Word A [*****]

Word B [*****]

[RATE] [EXTRNL]

[RATE] [10.0Hz] (Option 002 only)

Two fixed length 8 bit fully programmable words can be switched by a signal derived internally ([RATE] [X.XXHz]) or by a signal applied to the front panel EXT MODULATION IN port. When an external signal is used to switch words the Pattern field is set to [ALT WORD] [RATE] [EXTRNL].

Option 002 instruments

Note: The ALT WORD rate selection and the Jitter Modulation field on Page 4 Measurements are mutually exclusive, i.e. if ALT WORD is set to [RATE] [EXTERNAL] then Jitter Modulation on Page 4 Measurements is set to [INTERNAL] or [SPOT MASK] or [SWEPT MASK]. Similarly if the Modulation field on Page 4 is set to [EXTERNAL] then the ALT WORD rate is set to Word [RATE] [10.0Hz], (internal source).

[THRUDATA]

Option 002 instruments

In THRUDATA mode any signal applied to the HP 3784A RX DATA IN port is routed via an internal buffer store to the corresponding HP 3784A TX DATA OUT port.

Error Add

For Ternary Output Formats (i.e. HDB3, AMI) a choice of Bit or Code error addition is offered. Errors may be added singly or at a selected rate.

Er Add

[BIT]
[CODE]

Ternary operation: The type of error addition is selected from the field choices [MAN], [RATE] [3 to 6] or [OFF].

ER Add (bit)

This display is given when Binary Output Format is selected (i.e. Data Out field set to [BINARY]). Errors may be added singly [MAN] or at a selected rate [RATE] [3 to 6].

Clock Out

[NORM]

The phasing of the Transmitter clock is set to Normal.

[INV]

The Transmitter clock output polarity is inverted with respect to the data output.

Rx Setup (Page 3)

The HP 3784A Receiver offers a choice of interfaces and bit rates and the ability to have independent control or linked control to the Transmitter. The HP 3784A Receiver Pattern can be linked to the Transmitter except when the Transmitter Pattern is set to Alternating Word. The Receiver offers the 1-16 bit programmed word or PRBS choices when the Transmitter is in ALT WORD mode.

Auto Setup

When this mode is selected and the front panel key pressed, the HP 3784A automatically identifies a signal present on any of the HP 3784A Receiver front panel ports. The incoming signal data format, clock rate and pattern type is displayed on Page 3 Rx Setup.

The HP 3784A pattern recognition circuit (in Auto mode) will recognise word lengths up to 16 bits and PRBS's as specified for the HP 3784A Receiver Pattern. (see Table 6-1 Specifications) Zero substitution is not recognised.

```
3 Rx Setup [AUTO]
Connect test signal(s)...
Then press EXEC. key to start autoseup.
```

```
HELP: RX Setup [AUTO] can help identify
signal format, bit rate & test pattern.
Put signal in correct port & press EXEC.
See p4 for jitter measurements & setup.
```

The HP 3784A Receiver is configured and setup on Page 3, an example of which is given below. User selectable functions are Data In, Clock Rate, Pattern and Zero Sub (when a PRBS Pattern is selected). If the instrument includes option 002 Jitter Generation and Measurement an extra field Jitter Display Rate is shown.

```
3 Rx Setup [MAN] Data In [75 MON] [HDB3]
                        Clock Rate [34 MHz]
Pattern [PRBS] - [23]      Zero Sub [000]
Jitter Display Rate [FAST]
```

```
3 Rx Setup.      [ AS TX ]
Jitter Display Rate [FAST]
```

Data In

[BINARY]

In Binary operation the data input level may be selected from [ECL] into 75 ohms to -2V or [TTL] into 75 ohms to ground. (The level selection is common with the Transmitter) For option 002 instruments the jitter is measured from the clock signal.

Ternary

[75 TERM]
[75 MON]
[120 MON]
[120 TERM]

In Ternary operation the receiver data format is [HDB3] or [AMI] code RZ. The Receiver data input impedance may be selected from 75 ohms nominal unbalanced to ground at all four bit rates or 120 ohms nominal balanced selectable for bit rates 704, and 2048kHz. For option 002 instruments the received jitter is measured from the recovered clock.

[AS TX]

The Receiver Interface is set to the same setting as the Transmitter. The Receiver Clock Rate and Pattern (where appropriate) will mirror that of the Transmitter, or the Receiver Interface and Clock Rate can have independent selection.

[CO-DIR] (option 006)

Pulse shape as per CCITT G703, Figure 5/G703. Coding as per CCITT G703, Figure 4/G703.

Clock Norm

[NORM]
[INV]

The Clock Norm field is only displayed when the Data In field is set to [BINARY].

The receiver clock polarity can be set to Normal or Inverted.

Clock Rate

[704kHz]
[2MHz]
[8MHz]
[34MHz]

The Receiver Clock Rate may be selected from one of four fixed rates - 704kHz, 2048kHz, 8448kHz and 34368kHz. This field is not displayed when the Receiver Setup is linked to the Transmitter, i.e. [AS TX].

[64KHz] (option 006)

Option 006 provides an additional clock rate at 64kHz.

Pattern

[PRBS], [23], [20], [17], [15], [11], [9],[6]

The Receiver Pattern may be selected from one of seven PRBS lengths - [23], [20], [17], [15], [11], [9],[6].

Zero Sub

[000]

Up to 999 zeroes may be substituted for the data in the PRBS. Substitution starts at the first zero in the longest run of zeroes i.e. following the Trigger pulse position. Note. For [15] and [23], the trigger pulse position is at the start of the longest run of ones.

[WORD] [N]Bit [****]

An N bit fully programmable word is provided (where N is selectable from 1 to 16).

[AS TX]

Jitter Display Rate

Option 002 instruments.
[FAST], [SLOW], [MED]

The HP 3784A Receiver and Transmitter Patterns can be linked, except when the Transmitter Pattern is set to [THRUDATA] or [ALT WORD] modes. In these modes the Receiver pattern choice is PRBS or WORD as above.

The display rate determines the lowest frequency whose amplitude is measurable with the quoted accuracy.

The display rate always controls the update of the Receiver Jitter peak and p-p measurements and it controls the transmitter when [EXTERNAL] modulation is selected. For internal Transmitter modulation the display is automatically updated at the correct rate.

Lowest Frequency:

Fast >10Hz
Med >1Hz
Slow >0.1Hz

For frequencies below 0.1Hz the Receiver requires an external reference source.

Pressing the front panel key gives the following helpful information on Jitter Display rate.

HELP. Display Rate determines the lowest jitter frequency registered by peak & pp display. Fast ≥ 10 Hz, Med 1Hz, Slow 0.1
See P4 for jitter measurements & setup.

Measurements (Page 4)

The principal measurements performed by the HP 3784A are selected on Page 4 Measurements. The HP 3784A performs three types of measurements; Errors, Error Analysis and Losses. Loss measurements are viewed and selected on Page 6 Alarms.

Instruments fitted with Option 002 also include Jitter Generation and Measurement. Jitter measurements are also selected on Page 4. Measurements

Result Formats

Measurement results may be displayed in a number of different formats. Select Page 4 then use the UPDATE keys to select the type of measurement to be performed. A list of result formats for each measurement is given on Page 3-5 of the "Making Measurements" section, and also adjacent to some of the following displays, where applicable.

Help: Don't forget to use the front panel HELP key for useful information on the Page currently displayed. This information is shown to the right of the result displays in the following text.

ERROR RESULTS

```
4 [ ERROR RESULTS ] (Tx Jitter On)
Elapsed time..... 00d 00h 00m 00s
Rx [CODE ERR.][COUNT ].....
Rx Bit Error [RATIO ].....
```

```
4 [ ERROR RESULTS ] (Tx Jitter On)
Elapsed time..... 00d 00h 00m 00s
Rx [FREQUENCY] Offset..... ppm
Rx Bit Error [COUNT ].....
```

Receiver Interface set to Ternary

The [ERROR RESULTS] displays shown above are the ones given when the Receiver Interface (Data In field on Page 3 Rx Setup) is set to Ternary operation. If a Binary Interface is selected the Code Error results are omitted, and Rx Frequency measurement provided. If a ternary Interface is selected then the user can select either Code Errors or Rx Frequency Offset measurement.

```
4 [ ERROR RESULTS ] (Tx Jitter On)
Elapsed time..... 00d 00h 00m 00s
Rx Frequency..... Hz
Rx Bit Error [COUNT ].....
```

```
HELP. Selection of COUNT, RATIO, etc
can be made during or at the end of a
measurement. See P5 for interval choice.
See page 6 for durations of losses.
```

Receiver Interface set to Binary.

Rx Code Error/Bit Error Result Format: [RATIO], [COUNT], [FREE S], [SECS] or [FREE ds],[DECISEC].

Note: The choice of seconds or deciseconds is made on Page 5 Gating Period.

ERROR ANALYSIS

```
4 [ ERROR ANALYSIS ] (Tx Jitter On)
Result [AVAILABILITY].....%
Individual result thres. [NO]
Overall. ---- Individual Result. ----
```

```
HELP. The % availability has 10 sec
hysteresis and is the percentage of time
that error ratio is better than 10E-3.
For Jit Tol. Masks see p1 Preset [MASK].
```

Result: [AVAILABILITY], [UNAVAILABLE], [ERROR BURSTS]>100errs.
[ASY.ERR.SECONDS], [1 ERROR], [2-10ERS] or [>10ERS]
[DEGRADED MINS], [SEVERE ER. S.] or [ERRORED SECS].
[L.T. MEAN E.R.]

The Analysis results are taken from the Bit Error measurement results, and conform to CCITT G.821.

Individual result thres: [YES] [0.0E+00] or [NO]

AUTO TOLERANCE PLOT

Automatic jitter tolerance plotting is provided to test the tolerance of equipment to a jittered signal. The result is plotted graphically.

```
4 [AUTO TOLERANCE PLOT]
Set up interface and pattern on page 2
and connect Tx and Rx to the I.U.T. Then
connect a THINKJET and press EXEC. key.
```

```
HELP. Select Output Port on p9. Plot is
jitter tolerance for onset of errors.
See p1 Preset [MASK] for reference level
to be shown dotted on tolerance plot.
```

AUTO JITTER TRANSFER FUNCTION

Automatic jitter transfer plotting is provided to test the gain in jitter to a transmitted signal from the HP 3784A. The result is plotted graphically.

```
4 [AUTO JIT TRANSFR FN] Mode [PLOT]
Use CALibrate mode first then select the
Y axis Scale [10]dB. Connect THINKJET.
Then press EXEC to start.
```

```
HELP. Plot represents jitter gain for
the signal set up on Tx Setup page.
Tx = 0.75UI P-P. Plot is sent to device
connected to port selected on Page 9.
```

Scale: [1] or [10] db

Mode: [CALIBRATE] or [PLOT]

OUTPUT JITTER

```
4 [ OUTPUT JITTER ] Rx Range [10]
Elapsed time..... 00d 00h 00m 00s
Rx Jitter Hit [COUNT ].....
Rx Jitter [ PK-PK ] [OFF]..... UI
```

```
HELP. Measurement filters. OFF = None,
LP=F4 value on STD Lo Q Tolerance Mask,
HP1=F1 on STD mask & LP at F4, HP2=F3 &
LP at F4. Set mask at p1 Preset [MASK].
```

Rx Range: [1] or [10].

Rx Jitter Hit: [SECS], [COUNT] or [FREE S].

Rx Jitter: [POS PK], [NEG PK], [PK-PK] [HIT THRESHOLD] or [MAX P-P].

JITTER TOLERANCE

```
4 [ JITTER TOLERANCE ]
Modulation [ INTERNAL ]..... [1.00KHz]
Tx Jitter Amplitude P-P..... [2.45]UI
Rx Bit Error [COUNT ].....
```

```
HELP. '> BOUNDS' indication for Tx
Jitter Amplitude means that requested
amplitude exceeds instrument capability.
Select Tol. Mask at p1 Preset [MASK].
```

Modulation: [INTERNAL] or [EXTERNAL].
[SPOT MASK]-[STD or PROG].
[SWEPT MASK]-[STD or PROG].

Note: In [SWEPT MASK] mode the frequency is incremented in 20% steps until the highest mask frequency is reached. The direction of sweep is then reversed and decremented in 20% steps. The up and down sweeping will continue until some other form of modulation is requested.

Rx Bit Error: [SECS], [RATIO], [COUNT] or [FREE S].

JITTER TRANSFER FUNCTION

```
4 [ JITTER TRANSFER FN ] Rx Range [10]
Modulation [ INTERNAL ]..... [1.00KHz]
Tx Jitter Amplitude P-P..... [2.45]UI
Rx Jitter [ PK-PK ] [OFF]..... UI
```

```
HELP. For best accuracy measure both
Rx and Tx amplitudes using the Rx. For
Auto Trns. Fn. plot select at p4 title.
For Tol. Masks see p1 Preset [MASK].
```

Rx Range: [1] or [10].

Modulation: [SWEPT MASK] - [STD or PROG].
[INTERNAL] or [EXTERNAL].
[SPOT MASK] - [STD or PROG].

See Note on [SWEPT MASK] above.

Rx Jitter: [PK-PK], [NEG PK], [POS PK] or [MAX P-P].
[HIT THRESHOLD] [5.00] UIP.
[OFF], [HP1], [HP2] or [LP].

How to Control Measurement Gating (Page 5)

The HP 3784A measurement gating period and type of gating is selected on Page 5 Gating Period. There are two types of gating provided in the HP 3784A, Manual or Timed. There are two different timed modes, Single Shot and Repetitive. An example of a typical Gating Period page is shown below.

Note: Gating Type selection affects the selection of a number of functions in the HP 3784A other than just the measurement interval. For example, the HP 3784A can log data graphically to a Printer only when Repeat gating is selected. If Manual or Single gating is selected data can be logged in text form only.

When Manual or Single gating periods are used then intermediate results are available throughout the measurement interval. If Repeat gating is used then the results (other than Alarms) displayed are for the previous gating period.

```
5 Gating Period.  
Gating type [SINGLE]  
Period [ 0]d [ 0]h [ 1]m [ 0]s  
Errored/Error free intervals [SECONDS ]
```

```
HELP. Single measurements are  
started using the STOP/START key and  
stopped after the selected interval.
```

Note: There are also HELP pages given for Manual and Repeat gating.

Gating type:

[MANUAL]

The gating period is controlled by the **START/STOP** key. In process results are given throughout the measurement interval, and end of measurement results displayed and held (on Page 4 Measurements) until a new interval is started.

Timed [SINGLE]

The **START/STOP** key is used to initiate gating. The length of the timed interval is set by the user in the Period display fields on Page 5. This timed interval is settable in days, hours, minutes and seconds. Minimum timed interval is 1 second, while maximum is 99 days, 23 hours, 59 minutes, 59 seconds.

Timed [REPEAT]

The **START/STOP** key controls the total overall gating period over which Repetitive Measurements are made. The length of each individual timed interval is set by the user as for "SINGLE" mode. At the end of each timed interval the next interval is automatically started, and this will continue until such time as the **START/STOP** key is pressed to terminate the gating period. The results (other than Alarms) displayed are for the previous gating period. Note: There is no "dead" time between consecutive intervals.

Errored/Error free intervals

[SECONDS]
[DECISECONDS]

This field determines whether the Errored/Error Free measurement results given on Page 4 Measurements are displayed as intervals of seconds or deciseconds.



Alarms (Page 6)

On Page 6 Alarms the user is given a choice of selecting which type of errors will produce an audible tone when the front panel AUDIO key is enabled, and also monitoring the duration of various alarms. The HP 3784A front panel alarm leds indicate the occurrence of these alarms.

```

6 Alarms.
Audio source [BIT ERRORS ]
Duration of [RX CLK LOSS].....Secs
Cumulative Slip Deciseconds.....Secs

```

```

HELP. Power losses will delay the end
of timed measurements by duration of
the loss.

```

Audio Source: When the front panel Audio key is pressed (LED above key illuminates) an audible tone will sound when errors of the type selected in the Audio Source field occur, i.e. [BIT ERRORS], [CODE ERRORS] or for option 002 instruments [JITTER HITS]. Note. Code Errors is only offered when the Receiver Interface (Data In field on Page 3 Rx Setup) is set for Ternary operation, and the Page 4 measurement is code errors and not Rx frequency.

The frequency of occurrence of the errors (or hits) is reflected by the pitch of the tone.

Alarm Durations

The following Alarm Durations are calculated:

- Power Loss
- Tx Clock Loss
- Rx Clock Loss
- Data Loss
- Jitter Loss (Option 002 instruments)
- Sync Loss
- AIS

Cumulative Slip Deciseconds

The Slip measurement indicates when sections of the bit stream are repeated or omitted. Measurements are only performed when the HP 3784A Receiver Pattern is a PRBS.

Data Logging (Page 7)

Results can be logged to a printer via HP-IB or RS232 and may be presented in numeric or graphic form. Select Page 7 Data Log: in order to configure the HP 3784A to print to an external printer.

The following paragraphs list and give explanations of user selectable fields on the Data Log page (Page 7). An example of a typical Data Log display is given below. Please refer to the Data Logging section, Page 5-1 for practical examples of how to log data.

```
7 Data Log. Logging [ TEXT ]
Set-up [REAL-TIME] Log [PAGE 4 RESULTS]
Error [BIT RESULT ] Jitter [RX P-P RES]
Trigger [CODE ERR SECS] Squelch [OFF]
```

```
HELP. REAL TIME and SUMMARY logging
functions can be simultaneously in use
if required. Graphics mode is only
provided with repeat gating.
```

Graphics

To enable the HP3784A to output results in graphic form the "Gating Type" field on Page 5 Gating Period must be set to [REPEAT]. The Logging field on Page 7 is then set to [GRAPHICS], an example of which is given below.

Note: Results can only be output in graphic form when the HP 3784A is connected to an HP ThinkJet printer, model 2225A or for RS232 operation model 2225D.

```
7 Data Log. Logging [GRAPHICS]
Time axis tick every 20x Meas. Period.
Plot A records [BIT ERROR RATIO EXP ]
Plot B records [RX P-P JITTER VALUE ]
```

```
HELP. In Repeat Gating, graphics permits
two results to be plotted against time.
With RS232 THINKJET use 9600 baud, one
stop bit, no handshake, and parity none.
```

Set-up Field

The Set-up field should be treated as two separate pages, [SUMMARY] and [REAL TIME] and both should be considered separately. Please note that the "Gating Type" selected on Page 5 Gating Period determines which user selectable fields are displayed when "Real Time" is selected. For example if "Repeat" gating is selected then only two choices are available in the Log field, whereas for "Manual" or "Single" gating three choices are given.

REAL TIME

The following results and user selectable fields are offered when the **Set-up** field is set to [REAL TIME].

The **Gating type** field on Page 4 **Gating Period** determines which fields are presented to the user when the **Set-up** field on Page 7 is set to [REAL TIME]. Two distinct types of page are presented for each gating period selection as follows:

```
7 Data Log. Logging [ TEXT ]
Set-up [REAL-TIME] Log [PAGE 4 RESULTS]
Error [BIT RESULT ] Jitter [RX P-P RES]
Trigger [ONLY ON DEMAND]
```

Manual/Single Gating

```
7 Data Log. Logging [ TEXT ]
Set-up [REAL-TIME] Log [COUNTS/SECOND]
Type [BIT ERROR ]
Squelch [OFF]
```

Repeat Gating

Log

There are three choices given when [MANUAL] or [SINGLE] gating is selected on Page 5 **Gating Period**. If [REPEAT] gating is selected the [PAGE 4 RESULTS] choice is omitted. The choices are as follows:

[COUNTS/SECOND]

The number of Bit, Code or Jitter Hits (option 002) occurring in a second is logged.

[PAGE 4 RESULTS]

Manual/Single gating only.
This field indicates that the Page 4 Measurement Results selected in the **Error** and **Jitter** fields on Page 7, are the measurement results to be logged.

[NO RESULTS]

No results are logged during the gating interval.

Squelch

[ON]

The squelch feature suppresses continuous printing in the event of ten consecutive triggers in ten consecutive seconds. Squelch is released when one error free second occurs.

[OFF]

Logging is unaffected by squelch.

Error

The choices offered in the Error field vary depending on the Error Results selected on Page 4 Measurements, and whether the Receiver Interface is Binary or Ternary.

Choices for a Binary Receiver Interface.

[BIT RESULT]	When [BIT RESULT] is selected Bit Error Count is logged.
[RX FREQUENCY]	
[BIT & RX FR]	
[NO LOGGING]	No results are logged.

Choices for a Ternary Rx Interface.

[BIT RESULT]	
[RX FRQ OFST] OR [BIT & OFFST]	Rx [FREQUENCY] Offset selected on Page 4 Measurements.
[BIT RESULT]	
[CODE RESULT] OR [BIT & CODE]	When [CODE RESULT] is selected Code Error Count is logged.
[NO LOGGING]	

Jitter

The Jitter field has five selections:

[Rx P-P RES]	The Jitter measurement selected is calculated throughout the measurement interval.
[HITS RSLT]	
[P-P & HITS]	
[TX JIT FREQ]	
[NO LOGGING]	No Jitter measurements are logged.

Trigger

The Trigger field has five selections.

[HIT SECONDS]

The HP 3784A will log data on the occurrence of a HIT SECOND.

[PK AMP]>[***]

The HP 3784A will log data when the Receiver jitter peak amplitude exceeds the value selected in the [***] field.

[BIT ERR SECS]

The HP 3784A will log data on the occurrence of a BIT ERROR SECOND.

[CODE ERR SECS]

The HP 3784A will log data on the occurrence of a CODE ERROR SECOND. Only available when a Ternary Receiver Interface is selected, and when Rx [CODE ERROR] is selected on Page 4 Measurements

[ONLY ON DEMAND]

The HP 3784A will log only log data when the front panel LOG ON DEMAND key is pressed.

SUMMARY

```
7 Data Log. Logging [ TEXT ]
Set-up [ SUMMARY ]
Error [ BIT ] Jitter [ANL] Alrms [YES]
Trigger [BIT ERR RATIO] > 1.0E-[3]
```

The results selected from the **Error** and **Jitter** fields can be logged at the end of the gating period as a [SUMMARY].

A summary of the measurement type selected in the **Error** field is given at the end of the measurement period. The choices offered in the **Error** field vary depending on the **Error Results** selected on Page 4 **Measurements**, and whether the Receiver Interface is Binary or Ternary.

Error

Choices for a Binary Receiver Interface

[ALL] [BIT] [RX FR]
[ANLYS] [NO]

All five choices are available when the Receiver Interface (**Data In** field on Page 3 **Rx Setup**) is set to Binary. Select [NO] when an end of period summary is not required.

Choices for a Ternary Receiver Interface

[ALL] [BIT] [ANLYS] [NO]
[RX FR] OR [CODE]

The choice of [RX FR] or [CODE] is determined by the **Error Results** selection on Page 4 **Measurements**.

Jitter

The Jitter field has two selections

[ANL]

An analysis of Jitter measurement giving results of Hit Count; Max Peak-Peak UI; Hit Seconds and Hit Free seconds is included in the end of period summary.

[OFF]

The analysis results are not included in the end of period summary.

Alarms

The Alarms field has two selections.

[YES]

Alarms are recorded and included in the end of period summary. The durations are in seconds.

[NO]

Alarms are not included in the end of period summary.

Trigger

The choices offered in the Trigger field vary depending on the type of Receiver Interface selected, and the Error Results selected on Page 4 Measurements.

Trigger Choices for a Binary Interface

[ALWAYS]

The HP 3784A will log data whenever Bit or Code errors occur.

[BIT ERR RATIO] >1.0E-[3]

The HP 3784A will log data whenever the Bit Error Ratio exceeds the threshold set in the Trigger field.

[BIT ERR COUNT] >0

The HP 3784A will log data whenever the Bit Error Count value is greater than zero.

[HIT COUNT] >0

The HP 3784A will log data whenever the Hit Count is greater than zero.

Additional Trigger Choices for a Ternary Receiver Interface

[RX FR PPM]>[050]

The HP 3784A may be set to log data whenever the Receiver Frequency is offset by any value in the range 000 to 999 p.p.m. irrespective of sign.

[CODE ER RATIO] >1.0E-[N]
[N]= 3 to 9.

Code triggers are available when a Rx [CODE] Error Result is selected on Page 4 Measurements.

[CODE ER COUNT] > 0

Remote Control (Page 8)

The HP 3784A offers full remote capability via HP-IB (IEEE 488) and RS232 interface systems. An RS232 Modem port on the rear panel enables the HP 3784A to be controlled remotely via a Modem. HP-IB or RS232 operation is selected and configured on Page 8 Remote Port. A complete description of Remote Operation is given in the Remote Operation section of this manual. Note: The Remote error number displayed relates to an error condition which has occurred during Remote Operation. The Remote Operation section in this manual lists these error numbers and the associated error condition.

HP-IB

```
8 Remote Port. [HP-IB]      Address [05]
Status. Local
Remote error number.      0
```

```
HELP. Remote control can be either by
HP-IB or RS232 but when HP-IB talk only
mode is required (see page 9) then HP-IB
remote control must be deselected on p8.
```

HP-IB Modes

ADDRESSABLE: When the HP 3784A is operated with an external controller the addressable mode gives control of all front panel functions except the HP-IB address and **POWER** switch. All current results and flags are available and a local lock out facility is provided. A remote lamp adjacent to the display indicates when the instrument is under remote control.

TALK ONLY: TALK ONLY mode permits the HP 3784A to be used without an external controller. It is intended for the output of results to a peripheral such as a printer.

RS232 (Asynchronous)

Subpage [SETUP A]

```
8 Remote Port. [RS232] Subpage [SETUP A]
Connection [ MODEM ]      Duplex [FULL]
Enq/Ack [ON ]            Xon/Xoff [RX & TX]
```

```
HELP. For a choice of setup or status
info select from Subpage. SETUP A gives
choice of various handshakes/protocols.
SETUP B gives basic RS232 parameters.
```

Connection

[MODEM]
[HARDWIRED]

"Modem" provides modem control thus allowing the instrument to be accessed and controlled via both dial-up and leased circuits. "Hardwired" provides a simple interface using only TxD, RxD and GND. When [HARDWIRED] is selected all Modem control lines are ignored.

Duplex

[HALF]
[FULL]

If connection HARDWIRED is selected then the "Duplex" field will disappear because a hardwired connection is implicitly full duplex. Modem connections will be half or full duplex depending upon the type of modem used. This selection is necessary to ensure appropriate operation of the modem control lines. If half-duplex is selected then the "Xon/Xoff" field will disappear because the XON/XOFF handshake requires a full-duplex link to operate.

Enq/Ack

[OFF]
[ON]

This field selects whether or not data reception will be paced by the ENQ/ACK handshake.

Xon/Xoff

[OFF]
[RX ONLY]
[TX ONLY]
[RX & TX]

This field selects whether neither, either or both data transmission and reception is paced by the XON/XOFF handshake. In this context RX and TX have the following meaning..

RX - The instrument paces the rate at which it receives data by sending XON and XOFF characters to the controller.

TX - The controller paces the rate at which the instrument transmits data by sending XON and XOFF characters to the instrument .

This handshake is not available when half duplex is selected.

DTR

For modem connections DTR will normally be ON, however, for users who require manual control of DTR, this can be selected by means of an internal DIL switch prior to power-on. In this case the display will look like:

```
8 Remote Port. [RS232] Subpage [SETUP A]
Connection [ MODEM ] Duplex [FULL]
Enq/Ack [ON ] Xon/Xoff [RX & TX]
DTR [ON]
```

Note: Refer to Appendix D for information on internal switches.

DTR

[OFF]
[ON]

Using this field DTR can be turned ON prior to manually originating or answering a call, or it will turn ON automatically in response to a signal on circuit CE - Ring Indicator. The DTR field will always reflect the state of the DTR signal. During the progress of a call DTR will be ON, but can be manually turned OFF to cause the modem to disconnect. In all cases, if DSR does not turn ON within 60 seconds of DTR turning ON then DTR will automatically turn OFF. If DSR turns OFF, e.g. at the end of a call then DTR will turn OFF. By these means the user can be assured that DTR will be OFF when the instrument is OFF LINE. Note however, that this is NOT a requirement of RS232C which states quite explicitly that "the data terminal equipment is normally permitted to present the ON condition on circuit CD".

Subpage [SETUP B]

```
8 Remote Port. [RS232] Subpage [SETUP B]
Speed [ 1200 ]

7 Bit Data Parity [0's ] Stop Bits [1]
```

Speed

This field selects the data rate for transmission and reception.

[300], [600], [1200], [1800]
[2400], [4800], [9600]

```

8 Remote Port. [RS232] Subpage [SETUP B]
Speed [SELECT]           High Speed [1200]
                          Low Speed [ 300]
7 Bit Data Parity [0's ] Stop Bits [1]

```

[SELECT]

For (dual rate) modems which implement RS232C circuit CI - Data Rate Select (DCE source), the SELECT option allows the speed to be determined by the state of this circuit. When the SELECT option is chosen, additional fields appear for the user to enter the data rates to be associated with the ON and OFF states of circuit CI.

High Speed	[300], [600], [1200], [1800], [2400], [4800], [9600]
Low Speed	[300], [600], [1200], [1800], [2400], [4800], [9600]

During the call establishment procedure the state of circuit CI is sampled, and the data rate established, when the logical AND of DTR and DSR becomes TRUE. If circuit CI is found to be ON (+V at the interface) then the data rate is determined by the "High Speed" field selection, conversely, if circuit CI is found to be OFF (-V at the interface) then the data rate is determined by the "Low Speed" field selection. For maximum flexibility, the range of speeds available in one field is not restricted by the setting of the other, however, RS232C does state that for circuit CI "an ON condition shall select the higher data signaling rate". This facility is incorporated so that an operator who is experiencing excessive transmission errors at the high data rate can re-establish communications at the low data rate without re-configuring the instrument - which may be at a remote site. In accordance with the principal that when "Connection [HARDWIRED]" is selected all modem control lines are ignored, the "Speed [SELECT]" option will not be available. If the "speed [SELECT]" option is active when the user selects "Connection [HARDWIRED]" then the speed will be forced to the default value of 1200bps.

Note: By means of a strap setting at the RS232C interface, (on A26 Assembly) either pin 23 (RS232C standard) or pin 12 (industry standard) can be monitored as circuit CI. Also, pin 23 can be optionally strapped hi or lo.

Parity	This field selects the type of parity used for transmission and reception.
[ODD]	The parity bit is set to 0 or 1 by the transmit hardware so that there are an odd number of 1's in the code.
[EVEN]	The parity bit is set to 0 or 1 by the transmit hardware so that there are an even number of 1's in the code.
[0's]	The parity bit is always zero
[1's]	The parity bit is always one

Stop Bits

[1]
[2]

This field selects the number of stop bits to be used.

Subpage [STATUS]

The following display gives an example of the Status page with all mnemonics shown.

```
8 Remote Port. [RS232] Subpage [STATUS ]
Status. Local
  TXD - RXD  RTS  CTS  DSR  DCD  DTR
Remote error number.    0
```

Status:

The "Status" field reports the LOCAL/REMOTE status of the instrument. The other mnemonics have the following meanings,

TxD - Transmitted Data
RxD - Received Data
RTS - Request To Send
CTS - Clear To Send
DSR - Data Set Ready
DCD - Data Carrier Detect*
DTR - Data Terminal Ready

*DCD is used in preference to LSD (Line Signal Detect) because of possible confusion with Long Space Disconnect.

The mnemonics DTR, DSR etc, appear and disappear to reflect the status of the corresponding control circuits. The mnemonic appears when the circuit is ON (+V at the interface), and disappears when the circuit is OFF (-V at the interface). TxD and RxD are a special case, because of the rate at which these signals change state it would not be possible to represent them directly, instead the TxD and RxD indicators are toggled between the two states for the duration of data transmission and reception respectively. When data is not being passed the indicators will be off.

Indicators for "Ring Indicate" and "Data Rate Select" are not included because they are of secondary importance and because "Data Rate Select" may or may not be valid depending upon the setting of the CH/CI strapping.

Default Settings

The HP 3784A will set to the following when Preset Panel 0 is selected or when the instrument is switched on after a continuous memory loss (NVM) failure.

Connection	[MODEM]
Duplex	[FULL]
Enq/Ack	[OFF]
Xon/Xoff	[RX&TX]
DTR	[OFF]
Speed	[1200]
High Speed	[1200]
Low Speed	[300]
Parity	[1'S]
Stop Bits	[1]

Logging Port (Page 9)

The logging port selection which is set on Page 9 determines which port outputs data to a Printer. To output data via the HP-IB port (Talk Only mode) the Remote Port on Page 8 must be set to RS232. Since there are separate ports for RS232 Remote and Printer operation, the RS232 Logging Port may be selected irrespective of the settings on any other page. Typical displays for HP-IB and RS232 Logging Port selection, and a list of the choices offered for the fields within the RS232 page are given below.

HP-IB

```
9 Logging Port. [HP-IB]
```

```
Status. Talk only mode
```

```
HELP. THINKJET Talk-only switch setup.
```

```
LISTEN-> 1XXXXX
```

```
SRQ EN-> 0 XXXXX
```

```
ADDRESS SWITCHES, DON'T CARE
```

RS232

```
9 Logging Port. [RS232]
```

```
Speed [9600] Parity [NONE]
```

```
Stop Bits [1] Enq/Ack [NO ]
```

```
Xon/Xoff [NO ]
```

```
HELP. Preset Panel▶THINKJET MODE RS232
```

```
0 has RS-232 setup▶Switch 1-----8 1---5
```

```
for THINKJET. See ▶Set 1> 1 1
```

```
also page 8 HELP ▶Set 0> 00 00000 0000
```

Speed 110, 150, 300, 600, 1200, 2400, 4800, 9600

Stop Bits [1], [2]

Xon/Xoff [NO], [YES]

Parity [0's], [1's], [NONE], [ODD], [EVEN]

Enq/Ack [NO], [YES]

Note: Parity is fixed at [NONE] when Graphics Logging is selected on Page 7 Data Log.

Rear Panel Ports (Page 10)

A number of rear panel ports have dual functions, or may be enabled/disabled as required. These functions/operations are selected on Page 10 Rear Panel Ports. The ports concerned are:

- RX ERROR OUT
- MEASUREMENT IN.....(option 002 instruments only)
- RX REF CLOCK IN/OUT(option 002 instruments only)
- SELECTABLE PORT

The following display gives an example of Page 10 Rear Panel Ports.

```
10 Rear Panel Ports.   Error Out [BIT ]
                      Measurement In [DISABLE]
                      Rx Reference Clock [INT]
                      Selectable Port [TX TRIG OUT ]
```

Note: Detailed information on all rear panel ports is given in Section 2 "Getting Started".

Error Out Port:

[CODE]
[BIT]

The Error Out field selection determines which type of errors, Bit or Code are output from the rear panel **ERROR OUT** port. If the Receiver Interface is set to Binary no choice is offered, only Bit Errors are output.

Measurement In:

[ENABLE]

If [ENABLE] is selected the HP 3784A Jitter measurement and Hit counting circuits are disconnected from the internal demodulated jitter source and connected to the rear panel **MEASUREMENT IN** port. This facility enables users to insert external filters between the rear panel **DEMOD JITTER** output port and the measurement circuits. It can also be used to trigger logging from analogue signals.

[DISABLE]

The rear panel **MEASUREMENT IN** port is disabled, and jitter results are obtained directly from the internal demodulators.

Rx Reference Clock:

[EXT]

Enables an external signal to be used as a jitter free reference clock source for the HP 3784A Receiver. The port serving as an input.

[INT]

The HP 3784A Receiver reference clock is generated internally and is provided as an output.

Selectable Port

[Rx CLOCK OUT]

The Receiver Clock signal is available at the rear panel **SELECTABLE PORT** connector. This signal is the recovered clock before jitter is removed.

[Tx TRIG OUT]

The Transmitter **Trigger Output** is available at the **SELECTABLE PORT** connector. This signal may be used for timing delay measurements or correlation of errors to patterns.

Real Time Clock and Calendar (Page 11)

The HP 3784A provides a 24 hour real-time clock and calendar which can be set or viewed on Page 11. Battery back-up is provided for the clock therefore it is unaffected by AC line power hits. Also, the calendar is corrected for leap years.

```
11 Time & Date.           Mode [NORMAL]
Select SET mode to adjust time or date.
Date..... 01/01/1984
Time..... 00.00.00
```

```
HELP. Time is on 24 hour clock.
Calendar is corrected for leap years.
Select SET mode to set time or date.
Press EXEC. to restart clock/calendar.
```

Self-test (Page 12)

The HP 3784A has the ability to perform internal tests to check the condition of its processor and measurement hardware. The test routines are accessed on Page 12. A comprehensive list of error codes is given in Appendix F.

12 Self Test. Function [TYPE & REVISION]
Instrument Type. 3784A [Option 002]
Firmware Revision Number. 0000

HELP. Type & Firmware revision number
Numbers are release dates in form YYWW.
YY - Year number after 1960
WW - Week number of that year

12 Self Test. Function [TEST CPU]
CPU self test..... ----

Press EXEC. to run self-test.

HELP: Diagnostics mode provides guided
S.A. test. To get into diagnostic mode
move switch 2 of the DIL switch on A11
card to the backward pointing position.

12 Self Test. Function [TEST MODEM PORT]
RS232 modem port..... ----
Ensure loop-back plug is fitted to port
Press EXEC. to run self-test.

HELP.
Tests rear panel RS232 MODEM port.
RS232 loopback must be inserted.
(HP part number 5060-4462)

12 Self Test. Function [TEST PRINT PORT]
RS232 printer port..... ----
Ensure loop-back plug is fitted to port
Press EXEC. to run self-test.

HELP.
Tests rear panel RS232 Logging port.
RS232 loopback must be inserted.
(HP part number 5060-4462)

12 Self Test. Function [TEST CLCK SYNTH]
Clock Synthesiser Test..... ----
Cable Tx Clock Out to Rx Clock In.
Press EXEC. to run self-test.

HELP.
Tests clock synthesiser for correct
frequency generation in all ranges.

12 Self Test. Function [BER/INTFACE TST]
BER & Interface test..... ----
Cable required interface back to back.
Press EXEC. to run self-test.

HELP.
Tests Tx & Rx back to back with various
patterns, at the connected interface.

12 Self Test. Function [JITTER TESTS]
Tx & Rx Jitter test [ALL] ----
Cable Tern Data & Clock back to back.
Press EXEC. to run self-test.

HELP. Tests functionality of modulation
and demodulation circuits and checks
accuracy at various levels & frequencies

The TX & RX Jitter test field has five selections as follows:

[ALL], [CLOCK IO], [DATA IO], [FREQ/HIT] and [FILTERS].



Introduction

The HP 3784A can log measurement results either to an external HP-IB Printer, or to an external RS-232-C Printer. Results can be recorded in numeric or in graphical form, and may be printed both during a measurement and as a summary at the end of the measurement.

To set-up the HP 3784A to log data select Page 7 **Data Log**. The user-selectable fields displayed enable you to select the following:

- When results are logged.....Real Time and/or as an End of Period Summary.
- Whether results are logged in numeric or graphic form.
- The type of results logged in Real Time: Page 4 Results or Interval Counts.
- Which results are plotted in Graphics mode.

Recommended Printers

It is recommended that only HP ThinkJet and HP QuietJet Printers are used for Graphics logging. The following Printers are recommended

HP ThinkJet Printer Models 2225A (HP-IB operation) and 2225D (RS-232-C operation).

HP QuietJet Printer Models 2227A and 2228A both for RS-232-C operation.

Applications of Data Logging

Permanent Record of Results

Data logging to a Printer is useful whenever a permanent record of results is required. Examples: Experimental records during development and field trial of Transmission equipment. Proof of conformance to Error and Jitter performance standards when handing over a Transmission System after installation.

Time Stamped Logging

Time Stamped logging is useful when analysing time-varying error and jitter performance, since it allows the measurements to be run over long periods unattended.

Graphic Display of Results

The graphic mode makes it easy to pick out periods of excessive error activity in a large print-out.

Auto-plotting (option 002 instruments)

The auto-plotting mode for Jitter Tolerance and Jitter Transfer Function takes all the effort out of swept jitter measurements, and presents the results in an easy to interpret form.

Connecting the HP 3784A to a Printer

You may connect the HP 3784A via rear panel HP-IB or RS-232-C ports to an external Printer. Formatting assumes 80 columns and 66 lines per page. Instruction for connecting to both HP-IB and RS-232-C Printers are given in the following columns.

Log Results via HP-IB to Printer

Connect a cable from the HP 3784A rear panel HP-IB port to an external Printer.

On the HP 3784A, select Page 8 Remote Port, and set to [RS232].

```
8 Remote Port. [RS232] Subpage [STATUS ]
Status. Local

Remote error number. + 0
```

Select Page 9 Logging Port and set to HP-IB.

```
9 Logging Port. [HP-IB]

Status. Talk only mode
```

Log Results via RS-232-C to a Printer

Connect a cable from the HP 3784A rear panel RS232 PRINTER port to an external Printer.

On the HP 3784A, select Page 9 Logging Port and set to [RS232].

To enable data logging to take place the HP 3784A Protocol parameters (Speed, Stop Bits etc.) on Page 9 Logging Port must match those of the RS-232-C Printer being used.

```
9 Logging Port. [RS232]
Speed [9600]          Parity [ 0's ]
Stop Bits [1]        Enq/Ack [NO ]
Xon/Xoff [NO ]
```

The settings shown in the display above are those suitable for an HP ThinkJet Printer. If you are using another type of Printer, adjust the settings to suit the Printer being used.

Refer to the following procedure for instructions on how to configure an HP ThinkJet Printer for HP-IB or RS-232-C operation. If the Printer to be used is not an HP ThinkJet, refer to its user documentation for setting-up instructions.

Configure an HP-IB ThinkJet Printer

Select Page 9 Logging Port.

Ensure the Logging Port field is set to [HP-IB].

Press the front panel HELP key for instructions on setting an HP ThinkJet printer for HP-IB operation. (see following display)

```
HELP. THINKJET Talk-only switch setup.  
LISTEN-> 1XXXXX  
SRQ EN-> 0 XXXXX  
ADDRESS SWITCHES, DON'T CARE
```

Configure an HP RS-232-C ThinkJet Printer

Select Page 9 Logging Port.

Ensure the Logging Port field is set to [RS232].

Press the front panel HELP key for instructions on setting an HP ThinkJet Printer for RS-232-C operation. (see following display)

```
HELP. Preset Panel▶THINKJET MODE RS232  
0 has RS-232 setup▶Switch 1-----8 1---5  
for THINKJET. See ▶Set 1> 1 1  
also page 8 HELP ▶Set 0> 00 00000 0000
```

NOTE

The Printer reads the switch settings only when it is first turned on. Therefore, if you do change the settings, you must turn the Printer off for a few seconds and back on before printing.



Quick Guide to Data Logging with the HP 3784A

Use this guide for a quick reference on the type of logging available and how to select each mode. Refer to the pages intimated in the figure below for detailed logging modes.

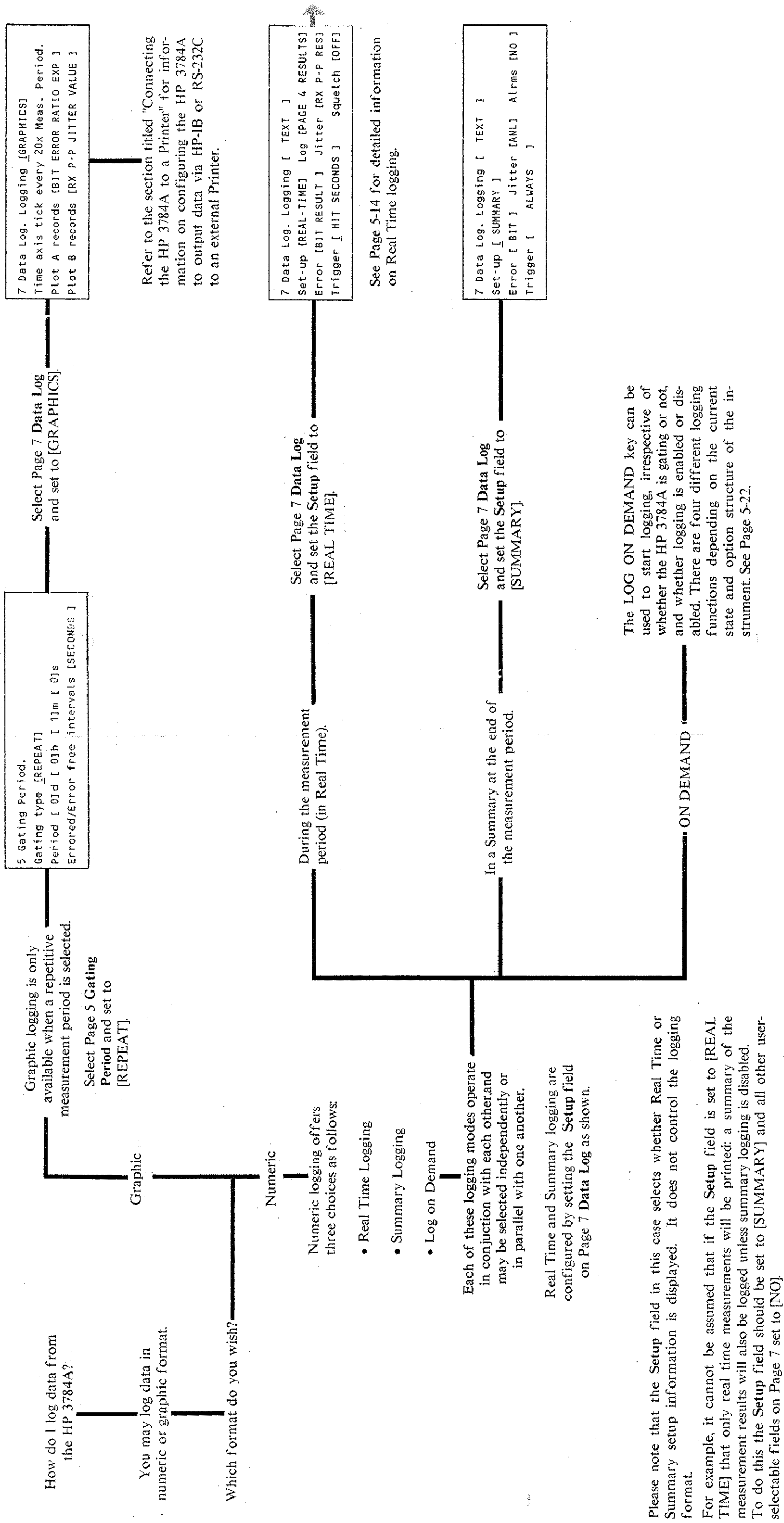

[PAGE 4 RESULTS]

Only available in Manual/Single gating.

The measurement result to be logged is the one selected in the Error field (on Page 7). On option 002 instruments the Jitter field selection can also be logged. See Page 5-16 for detailed information.

7 Data Log. Logging [TEXT]
Set-up [REAL-TIME] Log [PAGE 4 RESULTS]
Error [BIT RESULT] Jitter [RX P-P RES]
Trigger [ONLY ON DEMAND]

The Measurement Gating Period selected on Page 5 Gating Period directly affects the choices offered in the Log field on Page 7 Data Log. For example: the [PAGE 4 RESULTS] choices are not available for Repetitive gating periods.

[REAL TIME] Setup from Page 5-5.

There are three choices in the Log field as follows:

[NO RESULTS]

Only front panel ALARMS (i.e. POWER LOSS, SYNC LOSS etc) are logged.

7 Data Log. Logging [TEXT]
Set-up [REAL-TIME] Log [NO RESULTS]

[COUNTS/SECOND]

The number of Bit Errors or Code Errors in a second can be logged. See Page 5-15.

7 Data Log. Logging [TEXT]
Set-up [REAL-TIME] Log [COUNTS/SECOND]
Type [BIT ERROR]
Squelch [OFF]

Logging Bit Error Measurement Results

Introduction

The following procedure gives a practical example of how to configure the HP 3784A to perform a Bit Error measurement, and log the results in a summary at the end of the measurement period.

Procedure

Perform a Bit Error measurement over a Single 10 second gating period, and log the results in a summary at the end of the measurement period.

1. Connect a cable from the rear panel HP-IB or RS232 ports to the Printer. If an HP-IB Printer is being used set it to "Listen Always".
2. Switch on the HP 3784A.
3. Connect the Tx DATA OUT (75ohm) port to the RX TERNARY DATA IN (75ohm) port.
4. Select Page 1 Preset Panel, and set the HP 3784A to its default settings by setting the Function field to [RECALL FROM], Panel Memory to [0] and pressing the key.
5. Select Page 2 Tx Setup.....use the PAGE key. Set the Er Add field to [BIT] [RATE]-[3].....use the CURSOR POSITION and UPDATE keys.

```
2 Tx Setup.   Data Out [ 75 TERM] [HDB3]
Clock [STD RATE] [34 MHz] Offset [ +0]ppm
Pattern [PRBS]- [23]      Zero Sub [000]
Er Add [BIT ] [RATE]- [3] Clock Out [NORM]
```

Note: For this procedure we leave the Receiver Setup on Page 3 as per the default settings, i.e. identical to the Transmitter.

```
3 Rx Setup   [AS TX ]

Jitter Display Rate [FAST]
```

6. Select Page 4 Measurements.....use the PAGE key. Set Page 4 as follows:

```
4 [ ERROR RESULTS ] (Tx Jitter On)
  Elapsed time..... 00d 00h 00m 05s
Rx [CODE ERR.] [COUNT ].....
Rx Bit Error [RATIO ].....
```

7. Select Page 5 Gating Period.....use the PAGE key. Set the Gating type to [SINGLE] and period to [0], [0], [0], [10].

```
5 Gating Period.
Gating type [SINGLE]
Period [ 0]d [ 0]h [ 0]m [10]s
Errored/Error free intervals [SECONDS ]
```

8. Select Page 7 Data Log.....use the PAGE key. Set the Logging field to [TEXT], and the Setup field to [SUMMARY]. Set all other fields as shown below:

```
7 Data Log. Logging [ TEXT ]
Set-up [ SUMMARY ]
Error [ BIT ] Jitter [NO ] Alrms [NO ]
Trigger [ ALWAYS ]
```

Note: We only want to log a summary of measurement results at the end of the measurement period, and do not wish to log results during Real Time; therefore we also require to set the Setup field to [REAL TIME] and the Log field to [NO RESULTS].

```
7 Data Log. Logging [ TEXT ]
Set-up [REAL-TIME] Log [NO RESULTS]
```

10. If you wish to log data via HP-IB; proceed to step 11.
If you wish to log data via RS232; proceed to step 13.

11. **HP-IB Operation:**

Select Page 8 Remote Port.....use the PAGE key.

Set the Remote Port field to [RS232] - ignore other fields on this page for HP-IB operation. Proceed to step 12.

```
8 Remote Port. [RS232] Subpage [SETUP A]
Connection [ MODEM ] Duplex [FULL]
Enq/Ack [ON ] Xon/Xoff [RX & TX]
```

12. Select Page 9 Logging Port.....use the PAGE key. Set to [HP-IB], and then proceed to step 14.

```
9 Logging Port. [HP-IB]

Status. Talk only mode
```

13. **RS232 Operation:**

Select Page 9 Logging Port.....use PAGE key. Set to [RS232] as shown below: Set the other user-definable fields on Page 9, to suit the RS232 Printer being used.

```
9 Logging Port. [RS232]
Speed [9600] Parity [ 0's]
Stop Bits [1] Enq/Ack [NO ]
Xon/Xoff [NO ]
```

14. Press the key to start gating. The Printer output should be similar to the following:

```
Link      :                               Instrument : HP3784A
Tx Location:                               Tx Interface: 75ohm TERM HDB3
Rx Location:                               Tx Clock   : STD RATE 34MHz +0ppm
                                           Tx Pattern : PRBS 23 ZERO SUB 000
                                           Rx Interface: AS PER Tx'
                                           Rx Clock   : 34MHz
                                           Rx Pattern : AS PER Tx
                                           Rx Hit Thres: 5.00UIP
```

Sun, Jan 01, 1984 01:02:58 START OF SINGLE GATING 0d 0h 0m 10s

Sun, Jan 01, 1984 01:03:08 STOP, ELAPSED TIME 00 Days 00 Hours 00 Mins 10 Secs

SUMMARY:

Bit Error Result

```
Bit Error Count..... 343680 Bit Error Ratio..... 1.000E-03
Bit Error Secs..... 10 Bit Error Free Secs..... 0
```

Graphics Mode

Two measurement results can be plotted simultaneously against an x axis of time. One pair of points is recorded at the end of each instrument gating period. It is recommended that only HP ThinkJet and QuietJet Printers be used to log data graphically.

To select Graphics mode the HP 3784A Gating type (on Page 5 Gating Period) must be set to [REPEAT], and Page 7 Data Log set to Logging [GRAPHICS].

```
5 Gating Period.  
Gating type [REPEAT]  
Period [ 0]d [ 0]h [ 1]m [ 0]s  
Errored/Error free intervals [SECONDS ]
```

```
7 Data Log. Logging [GRAPHICS]  
Time axis tick every 20x Meas. Period.  
Plot A records [BIT ERROR RATIO EXP ]  
Plot B records [RX P-P JITTER VALUE ]
```

Plotted Results are:

- Bit Error ratio Exponent
- Code Error Ratio Exponent or Rx Frequency Offset (as selected on Page 4 Measurements).
- Note: Code Error Ratio Exponent or Rx Frequency Offset are not available for Binary Input signals, i.e. when the Receiver is set to [BINARY].

Option 002 Instruments

The following results in addition to those given above are plotted for option 002 instruments.

- Tx P-P Jitter Value
- Rx +PK Jitter Value
- Rx -PK Jitter Value
- Rx P-P Jitter Value

Typical Graphic Log of Results

The following printout gives an example of the format in which results are logged graphically.

```

Link      :                               Instrument : HP3784A
Tx Location:                               Tx Interface: 75ohm  TERM HDB3
Rx Location:                               Tx Clock   : STD RATE 34MHz  +0ppm
                                              Tx Pattern : PRBS 23 ZERO SUB 000
                                              Rx Interface: AS PER Tx
                                              Rx Clock   : 34MHz
                                              Rx Pattern : AS PER Tx
                                              Rx Hit Thres: 5.00UIP
    
```

Sun, Jan 01, 1984 01:05:48 START OF REPEAT GATING 0d 0h 0m 5s

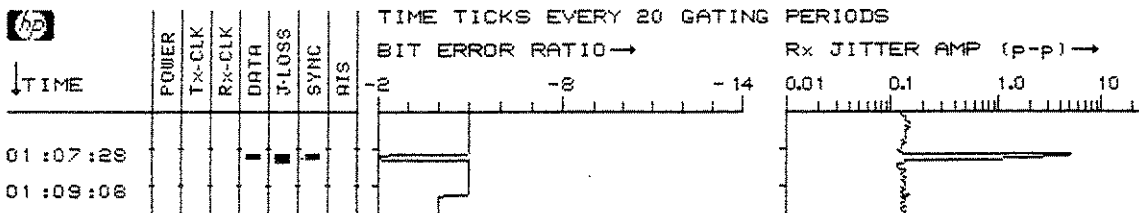

Sun, Jan 01, 1984 01:10:27 STOP, ELAPSED TIME 00 Days 00 Hours 00 Mins 03 Secs

Demonstration Procedure

An example giving simple step by step instructions on how to configure the HP 3784A to perform a measurement and log the results graphically is given on page 5-13.

Jitter Tolerance Plot

An example of a Jitter Tolerance plot is given on page 5-12.

Link :
Tx Location:
Rx Location:

Instrument : HP3784A
Tx Interface: 75ohm TERM HDB3
Tx Clock : STD RATE 34MHz +0ppm
Tx Pattern : PRBS 23 ZERO SUB 000
Rx Interface: AS PER Tx
Rx Clock : 34MHz
Rx Pattern : AS PER Tx
Rx Hit Thres: 5.00UIP

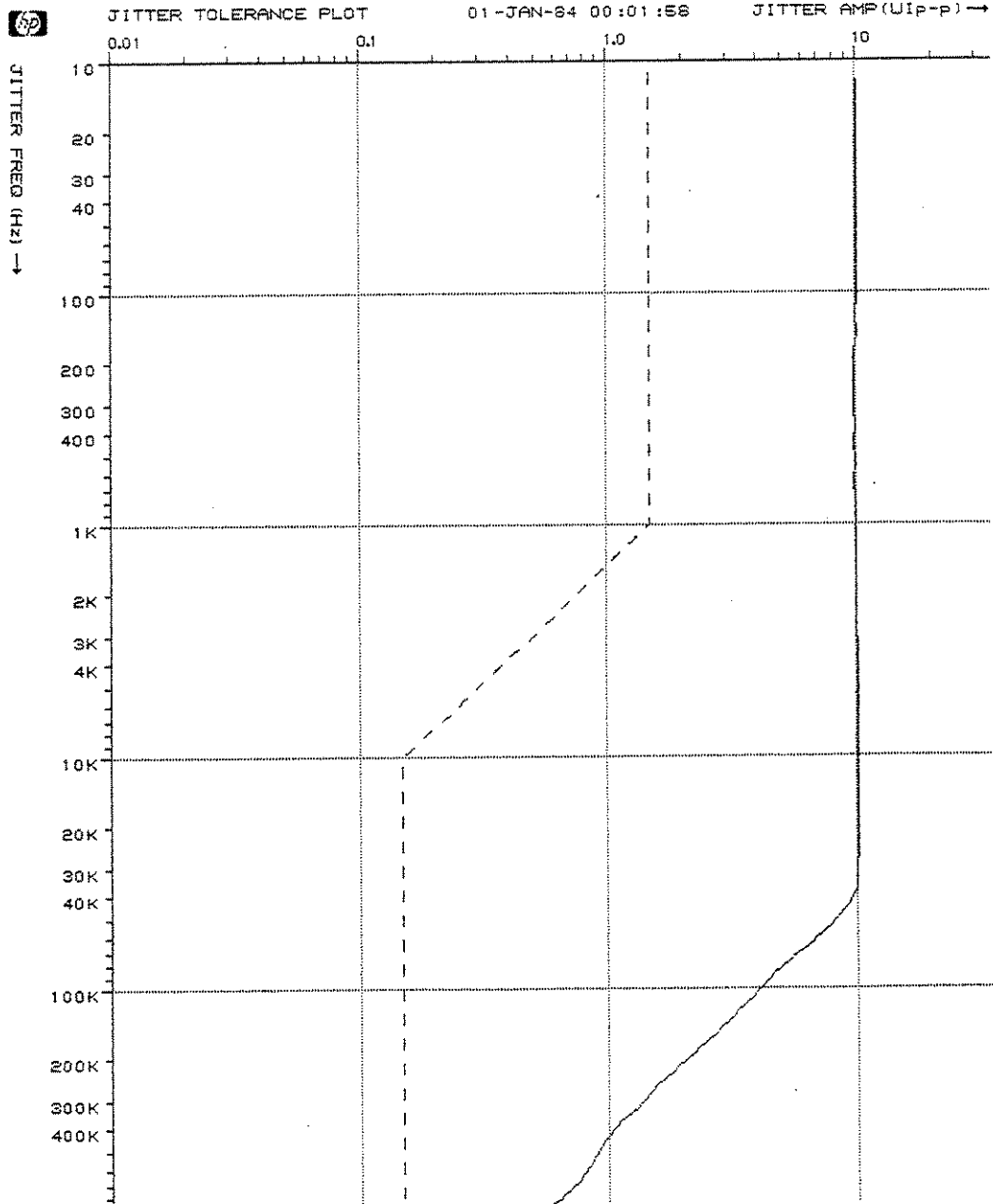

END OF JITTER TOLERANCE PLOT

Log Code Error Results Graphically

Introduction

The following demonstration procedure gives step by step instructions on how to configure the HP 3784A to perform a Code Error measurement and log the results graphically. Bit error ratio results are also logged.

1. Connect the HP 3784A to an external Printer via the rear panel HP-IB or RS232 Printer ports.
2. Connect the HP 3784A TX DATA OUT port to the HP 3784A RX TERNARY DATA IN port.
3. Switch on the HP 3784A.
4. Select Page 1 Preset Panel . Set the HP 3784A to its default settings by setting the Function field to [RECALL], Panel Memory to [0], and then press the key.
5. Select Page 2 Tx Set-up.
Set the Er add field to [CODE] [RATE]-[3].

```
2 Tx Setup.   Data Out [ 75 TERM] [HDB3]
Clock [STD RATE] [34 MHz] Offset [ +0]ppm
Pattern [PRBS]- [23]      Zero Sub [000]
Er Add [CODE] [RATE]- [3] Clock Out [NORM]
```

6. Select Page 3 Rx Setup and set as follows:

```
3 Rx Setup.   [ AS TX ]

Jitter Display Rate [FAST]
```

7. Select Page 4 Measurements .
Set the ERROR RESULTS measurements as follows:

```
4 [ ERROR RESULTS ] (Tx Jitter On)
Elapsed time..... 00d 00h 00m 00s
Rx [CODE ERR.] [COUNT].....
Rx Bit Error [COUNT].....
```

8. Select Page 5 Gating Period.
Set Gating type to [REPEAT] and period to [0], [0], [0], [4]s.

9. Select Page 7 Data Log.
Set Logging field to [GRAPHICS].

```
7 Data Log. Logging [GRAPHICS]
Time axis tick every 20x Meas. Period.
Plot A records [BIT ERROR RATIO EXP ]
Plot B records [CODE ERROR RATIO EXP]
```

10. For RS232-C Operation:

Select Page 9 Logging Port and set to [RS232]. Set the other fields on Page 9 to suit the RS232-C Printer being used. The settings given in the display below are those suitable for an HP ThinkJet Printer.

```
9 Logging Port. [RS232]
Speed [9600]          Parity [ 0's]
Stop Bits [1]        Enq/Ack [NO ]
Xon/Xoff [NO ]
```

11. For HP-IB Operation:

Select Page 8 Remote Port and set to [RS232], then select Page 9 Logging Port and set to [HP-IB].

```
8 Remote Port. [RS232] Subpage [SETUP A]
Connection [ MODEM ] Duplex [FULL]
Enq/Ack [ON ] Xon/Xoff [RX & TX]
```

```
9 Logging Port. [HP-IB]
Status. Talk only mode
```

12. Press the **START/STOP** key to start the HP 3784A gating.
13. Select Page 2 Tx Setup and try altering the Er Add [RATE]; the graph printed should indicate the change in error rate. Leave the error rate steady for >20 seconds in order to obtain a suitable printout.
14. Press the **START/STOP** key when you wish to stop the instrument gating and results being logged.

Results Printed in Real Time

Results logged for Manual/Single gating periods.

- Alarms only
- Counts/Second
- Page 4 Results

Results logged for Repeat gating period.

- Alarms only
- Counts/Second

Counts/Second

The number of bit or code errors occurring in a second can be logged. On option 002 instruments Jitter Hits may also be logged. On the occurrence of an error second the number of errors in that second, either Bit or Code will be logged. The relevant error second is the trigger for this logged result and no other trigger is provided.

The type of result to be logged is selected in the Type field on Page 7. Jitter Hit Counts/Second: Option 002 instruments

If [JITTER HIT] is selected in the Type field on Page 7, then on the occurrence of a Hit Second, the number of Hits in that second will be logged. The Hit Second is the trigger for this logged result and no other choice is provided.

An example of Page 7 Data Log with logging set to [COUNTS/SECOND] is shown below.

Note: Code Errors are not available if the HP 3784A Receiver Interface (Data In field on Page 3 Rx Setup) is set to Binary, or Rx [FREQUENCY] Offset is selected on Page 4 Measurements.

```
7 Data Log. Logging [ TEXT ]
Set-up [REAL-TIME] Log [COUNTS/SECOND]
                                Type [BIT ERROR ]
                                Squelch [OFF]
```

Page 4 Results Explained

When the Log field is set to [PAGE 4 RESULTS] the results of measurements displayed on Page 4 Measurements can be logged. The measurement results logged are those selected in the Error fields (on Page 7). On option 002 instruments the Jitter field selection can also be logged.

For example - if the HP 3784A includes option 002, and the Error and Jitter fields (on Page 7) are set to [BIT RESULT] and [TX JIT FRQ] respectively, the printout will be similar to the following:

<pre>4 [ERROR RESULTS] (Tx Jitter On) Elapsed time..... 00d 00h 00m 00s Rx [CODE ERR.][COUNT]..... Rx Bit Error [COUNT].....</pre>	<pre>7 Data Log. Logging [TEXT] Set-up [REAL-TIME] Log [PAGE 4 RESULTS] Error [BIT RESULT] Jitter [TX JIT FRQ] Trigger [BIT ERR SECS] Squelch [OFF]</pre>
--	--

```
Wed, Feb 01, 1989 10:39:55 START OF SINGLE GATING 0d 0h 0m 5s
Bit Error Result
Tx Jitter Frequency
and Alarm Conditions.
Real Time Trigger: Bit Errored Second
```

```
01-Feb-89 10:40:00 Bit Error Count..... 2
01-Feb-89 10:40:00 Tx Jitter Freq..... 1000Hz
```

```
Wed, Feb 01, 1989 10:40:00 STOP, ELAPSED TIME 00 Days 00 Hours 00 Mins 05 Secs
```

```
SUMMARY:
Bit Error Result
Bit Error Count..... 2 Bit Error Ratio..... 1.2E-08
Bit Error Secs..... 1 Bit Error Free Secs..... 4
```

Note: It is not possible to log Page 4 Results in Real Time when the instrument Gating type (on Page 5 Gating Period) is set to [REPEAT].

Table 5-1 lists the Page 4 Measurement and Page 7 Error field Logging choices, when the HP 3784A Receiver Interface is set to Binary and Ternary.

Table 5-1. Measurement/Error field choices

Receiver Interface	Page 4 Measurements	Page 7 Error field logging choices
Binary	Bit Error Rx Frequency	[BIT ERROR RESULT], [RX FREQ] [BIT ERROR & RX FREQ]
Ternary	Bit Error Code Error -or - Rx Frequency Offset	[BIT ERR], [CODE ERR], [BIT ERR & CODE ERR] OR [BIT ERR], [RX FREQ], [BIT ERR & RX FREQ]

Page 7 Jitter Field Choices: Option 002 instruments

[Rx P-P RES] - [HITS RESULT] - [P-P & HITS] - [Tx JIT FRQ] or [NO LOGGING].

End of Period Results Summary Explained

To log results in a summary, select Page 7 Data Log and set the Set-up field to [SUMMARY]. The results given in an end of period summary, are selected from the choices offered in the Error, Jitter and Alarms fields on Page 7.

If you do not wish an End of Period Summary set the Error, Jitter and Alrms fields to [NO].

An example of Page 7 with [SUMMARY] selected and typical printouts for each of the result choices offered is given below.

```
7 Data Log. Logging [ TEXT ]
Set-up [ SUMMARY ]
Error [ BIT ] Jitter [ANL] Alrms [YES]
Trigger [BIT ERR RATIO] > 1.0E- [3]
```

Error Field Choices:

Bit Error Results - [BIT]

SUMMARY:

Bit Error Result

```
Bit Error Count..... 5 Bit Error Ratio..... 1.8E-08
Bit Error Secs..... 2 Bit Error Free Secs..... 6
```

Code Error Results - [CODE] Ternary operation only.

SUMMARY:

Code Error Result

```
Code Error Count..... 12 Code Error Ratio..... 4.4E-08
Code Error Secs..... 2 Code Error Free Secs..... 6
```

Bit Error Analysis - [ANLYS]

SUMMARY:

Bit Error Analysis

```
Availability..... 100.00%   Number of Error Seconds with N errors:
Unavailability..... 0.0000%   1 error..... 1
Severely Errored Seconds. 0.0000%   2-10 errors..... 7
Error Secs..... 75.0000%   >10 errors..... 7
Degraded Minutes..... N/A
Error Bursts>100 Errors..... 1   L.T.Mean Err.Ratio... 1.203E-05
```

Receiver Frequency Offset - [RX FR OFST] Ternary Operation Only

SUMMARY:

Rx Clock Frequency Offset

```
Rx Clock Freq Offset..... +36ppm
```

Receiver Frequency - [RX FREQUENCY] - Binary operation only.

SUMMARY:

Rx Clock Frequency
Rx Clock Frequency..... 34369239Hz

[ALL] - All of the results shown above (BIT, CODE or RX FREQ OFFSET plus ANLYS and RX FREQ) are logged.

Link	:	Instrument	: HP3784A
		Tx Interface:	75ohm TERM HDB3
Tx Location:		Tx Clock	: STD RATE 34MHz +36ppm
		Tx Pattern	: PRBS 23 ZERO SUB 000
Rx Location:		Rx Interface:	AS PER Tx
		Rx Clock	: 34MHz
		Rx Pattern	: AS PER Tx
		Rx Hit Thres:	5.00UIP

Wed, Feb 01, 1989 10:58:27 START OF SINGLE GATING 0d 0h 0m 8s
Bit Error Result
Tx Jitter Frequency
and Alarm Conditions.
Real Time Trigger: Bit Errored Second

01-Feb-89 10:58:28 Bit Error Count..... 34
01-Feb-89 10:58:28 Tx Jitter Freq..... 1000Hz

01-Feb-89 10:58:29 Bit Error Count..... 69
01-Feb-89 10:58:29 Tx Jitter Freq..... 1000Hz

01-Feb-89 10:58:30 Bit Error Count..... 103
01-Feb-89 10:58:30 Tx Jitter Freq..... 1000Hz

01-Feb-89 10:58:31 Bit Error Count..... 125
01-Feb-89 10:58:31 Tx Jitter Freq..... 1000Hz

Wed, Feb 01, 1989 10:58:35 STOP, ELAPSED TIME 00 Days 00 Hours 00 Mins 08 Secs

SUMMARY:

Bit Error Result

Bit Error Count..... 125 Bit Error Ratio..... 4.55E-07
Bit Error Secs..... 4 Bit Error Free Secs..... 4

Bit Error Analysis

Availability..... 100.00%	Number of Error Seconds with N errors:
Unavailability..... 0.0000%	1 error..... 0
Severely Errored Seconds. 0.0000%	2-10 errors..... 0
Error Secs..... 50.000%	>10 errors..... 4
Degraded Minutes..... N/A	
Error Bursts>100 Errors..... 1	L.T.Mean Err.Ratio.... 4.55E-07

Code Error Result

Code Error Count..... 0 Code Error Ratio..... 0
Code Error Secs..... 0 Code Error Free Secs..... 8

Jitter: Option 002 instruments.

You may elect to have Jitter Analysis results logged in addition to any of the results available in the standard instrument.

Jitter

Jitter Analysis - [ANLYS]; provides a log of the following:

- Hit Count Result
- Hit Second/Decisecond Count (i.e. number of seconds/deciseconds)
- Hit Free Second/Decisecond Count
- Maximum Rx P-P Value in the last gating period.

SUMMARY:

Rx Jitter Analysis
Hit Count..... 16000 Max Peak-Peak..... 8.02UI
Hit Seconds..... 8 Hit Free Secs..... 0

Alarms:

SUMMARY:

Alarm Durations (seconds)
Power Loss..... 0.0 Tx Clock Loss..... N/A Rx Clock Loss..... N/A
Rx Data Loss..... 3.0 Sync Loss..... 3.1 AIS Secs..... 0.0
Jitter Loss..... 6.2 Slip Secs..... 0.3

Note: The Slip Durations and Alarm Durations results are displayed on Page 6 Alarms.

What Triggers Logging?

The selection of Trigger fields on Page 7 Data Log, and the front panel LOG ON DEMAND key initiate logging.

The type of logging trigger offered will vary, depending on whether data is logged in Real Time, or as an End of Period Summary. This is explained in the following text.

Note: Code Error Triggers are not available when the Receiver Interface is set for Binary operation, or when the [ERROR RESULTS] display on Page 4 is set to Rx [FREQUENCY] Offset.

Logging Trigger during Real Time

The trigger for logging during Real Time for Page 4 Results can be any one of the following:

- Bit Error Seconds
- Code Error Seconds or Rx Frequency Offset
- Only On Demand (i.e. on pressing LOG ON DEMAND key)
- Jitter Hit Seconds - (option 002 instruments)
- Rx Peak Jitter Amplitude >[0.50 to 5.00].....(option 002 instruments)

7 Data Log. Logging [TEXT]
Set-up [REAL-TIME] Log [PAGE 4 RESULTS]
Error [BIT RESULT] Jitter [RX P-P RES]
Trigger [BIT ERR SECS] Squelch [OFF]

Note: The Receiver Peak Jitter Amplitude can also be used to trigger logging when external voltages applied to the rear panel Measurement In port exceed the Trigger threshold value set on Page 7 Data Log. If you wish further information on this refer to the paragraph titled External Triggering at the rear of this section.

Logging Trigger for End of Period Summary

The trigger for logging an end of period summary can be any one of the following:

- Bit Error ratio $>1.0E-3$ to $1.0E-9$
- Bit Error Count >0
- Code Error Ratio $>1.0E-3$ to $[1.0E-9]$
- Code Error Count >0
- Jitter Hit Count >0(option 002 instruments)
- Always
- Rx Frequency Offset $>\pm$ xxxppm (Range: \pm 999ppm)

```
7 Data Log. Logging [ TEXT ]
Set-up [ SUMMARY ]
Error [ BIT ] Jitter [ANL] Alrms [YES]
Trigger [BIT ERR RATIO] > 1.0E- [3]
```

Note: Code Error Ratio/Count and Rx Frequency Offset are mutually exclusive. The [ERROR RESULTS] selection on Page 4 Measurements determines whether the Logging Trigger is Code or Rx Frequency Offset.

Log On Demand

The LOG ON DEMAND key can be used to start logging, irrespective of whether the HP 3784A is gating or not, and whether logging is enabled or disabled. There are four different logging functions depending on the current state and option structure of the instrument.

Note: Data will not be logged unless the Logging Port field (on Page 9 Logging Port) is set correctly, and a Printer connected to the appropriate rear panel HP-IB or RS-232 port.

The following text explains the operation of the LOG ON DEMAND key with four specific instrument functions.

1. Instrument Gating in Manual or Single modes with Logging disabled:

Standard Instrument	The Trigger field on Page 7 Data Log is set to [ONLY ON DEMAND] and the current Real Time, Page 4 Error Results of [BIT & CODE] are logged. Note that a summary of Alarm Durations will also be given if the ALRMS field had been set to [YES] prior to switching the logger off.
----------------------------	---

Option 002 Instruments	As for standard instruments plus Jitter P-P and Hits logged.
-------------------------------	--

2. Instrument Gating in Repeat mode with Logging disabled:

Standard Instrument	Logging is enabled for Interval Counts during Real Time with Squelch ON, and for an End of Period Summary of Bit Error results, without Alarm Durations, and with a Trigger of Bit Error Count >0. The HP 3784A will continue logging results during each gating period until stopped by the user. (press STOP key)
----------------------------	---

Option 002 Instruments	As for the standard instrument. Jitter Analysis results are not logged.
-------------------------------	---

3. Instrument Gating in Manual or Single modes with logging enabled for Real Time [PAGE 4 RESULTS].

Standard Instruments	The Logging setup on Page 7 Data Log is not changed, but the selected results from the Error field on Page 7 are logged as if the selected Trigger had been triggered. Note: An End of Period Summary will also be given unless the Error, Jitter and Alrms fields on the [SUMMARY] Set-up page are set to [NO].
-----------------------------	---

Option 002 Instruments	Identical to the standard instrument with the addition of results selected from the Jitter field on Page 7 logged.
-------------------------------	--

4. Instrument Not Gating:

The complete Summary of results analysis and Alarms is printed for the measurements from the last gating period.

The Real Time Set-up on Page 7 is set to [PAGE 4 RESULTS]; Error [BIT & CODE]; Jitter [P-P & HITS] and Trigger [ONLY ON DEMAND].

The SUMMARY page is set to: Error [NO]; Jitter [NO], but Alarms will stay at [YES] if previously selected. The Trigger is [ALWAYS].

What Stops Logging?

Press the front panel LOGGING STOP key to terminate all logging operations. The Logging field on Page 7 Data Log is set to [DISABLED].

Squelch

The Squelch field is only displayed when [REAL TIME] Set-up is selected, and operates for both Page 4 Results and Interval Counts. This feature inhibits logging if the trigger is operated for 10 consecutive seconds, thus preventing excessive use of Printer paper. The squelch inhibit is lifted after one error free second.

External Triggering (option 002 only)

Using the MEASUREMENT IN port on the rear panel it is possible to trigger logging when an externally applied voltage (eg. an a.g.c. voltage) exceeds the trigger threshold. Although the jitter trigger is shown in terms of U.I. this can be converted to a voltage threshold using the sensitivity specification of the MEASUREMENT IN port (same as DEMOD JITTER OUT port).

When the level of the input signal exceeds a user defined threshold logging will occur. To enable data logging to be triggered via the Measurement In port set the HP 3784A as follows:

1. Select Page 10 Rear Panel Ports and set the Measurement In field to [ENABLE].

```
10 Rear Panel Ports.   Error Out [CODE]
                      Measurement In [ENABLE ]
                      Rx Reference Clock [INT]
                      Selectable Port [TX TRIG OUT ]
```

2. Select Page 7 Data Log.
Set the HP 3784A to log [PAGE 4 RESULTS] in [REAL TIME].
Set the Trigger field to [PK AMP] and the >[*]**] field as required.

```
7 Data Log. Logging [ TEXT ]
Set-up [REAL-TIME] Log [PAGE 4 RESULTS]
Error [BIT & CODE ] Jitter [RX P-P RES]
Trigger [PK AMP]>[ 2.50] Squelch [OFF]
```

If the Trigger field is set to [PK AMP] >[2.50], then whenever the Voltage at the Measurement In port exceeds 0.25 volts peak the HP 3784A will log the Page 4 Results selected on Page 7 Data Log.

Introduction

On the title page of this manual, below the manual part number, is a microfiche part number. This number can be used to order this manual in 10 x 15cm microfilm transparencies, each transparency contains up to 96 photo duplicates of the manual pages.

A Remote Operation manual (part number 03784-90001) containing all the necessary information to operate the HP 3784A remotely, is also supplied with the instrument.

Option 915 provides a service manual (part number 03784-90002) which contains the information necessary to maintain and repair the HP 3784A.

Specifications

Instrument specifications are listed on page 6-3. These specifications are performance standards or limits, against which the instrument is tested.

Safety Considerations

The HP Model HP 3784A Transmission Analyzer is a Safety Class I (IEC) instrument. This instrument has been designed according to international safety standards. The instrument and manuals should be reviewed for safety markings and instructions before operation.

This manual contains information, cautions and warnings which must be followed by the user to ensure safe operation and retain the instrument in a safe condition.



REFER TO SERVICE MANUAL: This symbol on the instrument means the user must refer to the Service Manual to protect the instrument from damage.



PROTECTIVE EARTH GROUND: Indicates protective earth ground terminal of the ac power source on the instrument. All exposed metal surfaces on the instrument must connect to a protective earth ground terminal.



FRAME OR CHASSIS TERMINAL: This symbol identifies a terminal that is normally common to all exposed metal surfaces on the instrument.

WARNING

The **WARNING** sign denotes a hazard to the operator. It calls attention to a procedure, practice, or the like, which, if not correctly performed or adhered to, could result in injury or loss of life. Do not proceed beyond a **WARNING** sign until the indicated conditions are fully understood and met.

CAUTION

The **CAUTION** sign denotes a hazard to the instrument. It calls attention to an operating or maintenance procedure, practice, or the like, which, if not correctly performed or adhered to could result in damage to or destruction of part or all of the instrument. Do not proceed beyond a **CAUTION** sign until the indicated conditions are fully understood and met.

Instruments Covered By Manual

Attached to the rear panel of the instrument is a serial number plate. The serial number plate has a four digit serial prefix, a reference letter denoting country of origin (U=United Kingdom) and a five digit serial number. The serial prefix is the same for all identical instruments, it changes only when a change is made to the instrument. The serial number is unique to each instrument.

The contents of this manual apply directly to all instruments with a serial number prefix listed under **SERIAL NUMBERS** on the title page. An instrument manufactured after the printing of this manual may have a serial number prefix that is not listed on the title page. This unlisted serial number prefix indicates that the instrument is different from those described in the manual. The Operating and Calibration Manual for this instrument is supplied with a blue Manual Changes supplement, which contains the change information that documents the differences and explains how to adapt these manuals to the newer instruments.

In addition to change information, the Manual Changes supplement may contain information for correcting errors in the manuals. To keep this manual as current and as accurate as possible, Hewlett-Packard recommends that you periodically request the latest Manual Changes supplement, quoting this manual's print date and part number (both of which appear on the title page). Complimentary copies of the supplement are available from Hewlett-Packard.

For information concerning a serial number prefix which is not listed on the title page or in a Manual Changes supplement contact your nearest Hewlett-Packard office.

Specifications

Except where otherwise stated, the following parameters are warranted performance specifications. Parameters described as "typical" or "nominal" are supplemental characteristics which provide a useful indication of typical, but non-warranted, performance characteristics.

User Assistance Features

Measurement Preset Panels

Five completely independent instrument setups can be stored in non-volatile memory for later recall. A separate fixed memory location contains a default setup.

Autoconfigure of Receiver

The HP 3784A receiver can be set to automatically identify the bit rate, line code and test pattern of a signal applied to its input ports. Zero substitution, and non-standard and severely errored signals are not recognized.

Keyboard Lock

This feature locks front panel keys which change settings or control measurements.

Help Key

Pressing this key displays helpful information relevant to the current instrument settings.

Audio Error Indicator

When this is switched on the HP 3784A emits a tone whose pitch is proportional to the detected error rate.

Self Tests

Automatic self tests are provided which can be used to check the functional operation of the instrument after transportation or a long period of storage.

Transmitter

Internal Fixed Clock

Rates: 704, 2048, 8448 and 34368 kHz.

Accuracy: ± 3 ppm.

Aging: Typically $\leq \pm 1$ ppm per year.

Offsets: Settable in the range 0 to ± 99 ppm, in 1 ppm steps.

Internal Variable Clock

Range: 1 kHz to 50 MHz.

Resolution:

1 to 312 kHz, in 100 Hz steps;

312 to 3126 kHz, in 1 kHz steps;

3126 to 6252 kHz, in 2 kHz steps;

6252 to 12504 kHz, in 4 kHz steps;

12504 to 25008 kHz, in 8 kHz steps;

25008 to 50016 kHz, in 16 kHz steps.

Accuracy: ± 3 ppm.

Aging: Typically $\leq \pm 1$ ppm per year.

Offsets: Settable in the range 0 to ± 99 ppm, in 1 ppm steps.

External Clock Input

Range: 1 kHz to 50 MHz.

Displayed Frequency

Accuracy: ± 3 ppm, ± 1 count.

Input Impedance: 75 Ω nominal to ground.

Sensitivity: ≥ 500 mV p-p.

Max Amplitude: 5 V p-p (within limits of ± 5 V).

Min Pulse Width:

1 kHz to 10 MHz: 10% pulse or space.

10 MHz to 50 MHz: 10 ns pulse or space.

The output clock (and ternary data) pulse width is dependent upon the pulse width of the external clock, except when jitter generation is employed.
Connector: BNC.

PRBS Test Patterns

2⁶-1;

2⁹-1, as in CCITT Rec V.52;

2¹¹-1, as in CCITT Rec O.152;

2¹⁵-1, as in CCITT Rec O.151;

2¹⁷-1;

2²⁰-1 (not zero-limited);

2²³-1, as in CCITT Rec O.151.

Zero Substitution: 1 to 999 zeros can be substituted for data starting at the first bit in the longest run of zeros in any PRBS. The bit after the substituted zeros is set to 1.

Word Test Patterns

N-bit fully programmable, where N can be set from 1 to 16 bits.

Pattern Trigger Output

Output appears at rear panel Selectable port. One pulse per PRBS or Word pattern. (Pulse precedes the longest run of zeros in the PRBS and precedes the first bit in the Word pattern.)
Pulse Width: Nominally one clock period.

Selectable Port

Level: Nominal ECL.

Impedance: Nominal low, unbalanced to ground.

External Load: 50 Ω to -2 V, dc coupled; 50 Ω to ground, ac coupled.

Connector: BNC, rear panel.

Alternating Word Test Pattern

2 x 8-bit fully programmable words alternated by a signal applied to the Ext Modulation In port. See also Option 002.

Frequency Range:

dc to 100 kHz for square waves.

Voltage Range: 600 mV to 3 V p-p.

Switch Threshold: Nominally ground.

Impedance: 50Ω nominal to ground.

Connector: BNC.

Error Injection

Error Types: Bit or code.

Error Add: Single or at a fixed rate of 1 in 10^n . n = 3, 4, 5, 6.

Binary Data: Only bit errors can be added.

Ternary Data: Bit or code errors may be added.

Note: Bit errors are added before encoding.

HDB3 Code Errors: Positive or negative marks are set to zero and zeros are set to positive marks. This also causes bit errors to be induced.

AMI Code Errors: Positive marks are set to negative marks and vice versa.

Clock Output

Level: Selectable, nominal TTL into 75Ω to ground or nominal ECL into 75Ω to -2 V.

Note: The selection of ECL or TTL is common for data and clock. The receiver data input level selection is linked to the transmitter.

Impedance: 75Ω.

Duty Cycle (When using internal fixed clock): 50 ± 6 %.

Polarity: Selectable normal or inverted.

Connector: BNC

Data Output – Binary Mode

Format: NRZ.

Level: Selectable, nominal TTL into 75Ω to ground or nominal ECL into 75Ω to -2 V.

Note: The selection of ECL or TTL is common for data and clock. The receiver data input level selection is linked to the transmitter.

Impedance: 75Ω.

Data Output – Ternary Mode

Format: RZ.

Line Code: Selectable AMI or HDB3.

Amplitude:

704, 2048, 8448 kb/s:

Unbalanced, 2.37 V peak ± 10%;
704, 2048 kb/s: Balanced, 3.0 V peak ± 10%.

34368 kb/s: Unbalanced, 1.0 V peak ± 10%.

Amplitude Ratio +ve/-ve: 1:1.0 ± 0.05.

Transition Times: 20% to 80%; unbalanced, <5 ns; balanced, <10 ns.

Overshoot: <10% of pulse amplitude.

Impedance: Selectable 75Ω unbalanced to ground at all four fixed rates or 120Ω balanced at 704 and 2048 kb/s.

Protection: Open and short circuit protected, ± 6 V short term.

Connector:

Unbalanced Output: BNC.

Balanced Output: 3-pin Siemens.

Receiver

The Receiver interface clock rate and pattern can be linked to the Transmitter or set independently.

Clock Input

Level: Suitable for TTL or ECL

Frequency Range: 1 kb/s to 50 Mb/s.

Impedance: ac coupled, terminated in nominal 75Ω.

Polarity: Selectable normal or inverted.

Connector: BNC.

Data Input – Binary Mode

Format: NRZ.

Frequency Range: 1 kb/s to 50 Mb/s.

Level: Selectable, nominal TTL into 75Ω to ground or nominal ECL into 75Ω to -2 V.

Note: The selection of ECL or TTL is common for transmitter data and clock. The receiver data input level selection is linked to the transmitter.

Connector: BNC.

Data Input – Ternary Mode

Format: RZ.

Clock Recovery Rates: 704, 2048, 8448 and 34368 kb/s.

Rate Tolerance: ± 120 ppm.

Line Code:

704, 2048 kb/s: AMI with up to 24 zeros or HDB3.

8448, 34368 kb/s: HDB3.

Amplitude:

704, 2048 and 8448 kb/s:
Unbalanced, 2.37 V nominal peak.
704, 2048 kb/s: Balanced, 3.0 V nominal peak.
34368 kb/s: Unbalanced 1.0 V nominal peak.

Impedance:

Nominal 75Ω unbalanced to ground at all four rates;
Nominal 120Ω balanced to ground selectable at 704 and 2048 kb/s.

Pulse Width: (50 ± 6)% of bit period.

Equalization: Automatic √f equalization conforming to CCITT Rec G.703 operates at all rates. The maximum loss at half the bit rate compensated for is 3 dB at 704 kb/s, 6 dB at 2048 and 8448 kb/s, and 12 dB at 34368 kb/s.

Monitor Mode: At each ternary input rate a "Mon" mode is available which provides additional flat gain for operation at protected monitor points.

This gain is 30 dB at 704, 2048 and 8448 kb/s, and 26 dB at 34368 kb/s.

Connector:

Unbalanced: BNC.
Balanced: 3-pin Siemens.

Receiver Clock Output

Can be selected to appear instead of the Transmitter Pattern Trigger Output signal at the Selectable port. Clock is either recovered from ternary data or is the binary clock input to the Rx Clock In port.

Measurement Timing**Real-time Clock**

Function: Provides time and date information for event logging, gating period timing and error performance measurements.

Date: Day, month, year; the clock compensates for leap years and monthly day variances.

Time: Hours, minutes and seconds.

Elapsed Time: Shows elapsed time since the start of the gating period; resets to zero at the start of each repetitive gating period; holds value when Stop key pressed to terminate the measurement.

Accuracy: +0.015%/-0.005% ± 1 ms.

Resolution: ± 1 second.

Battery Back-up: Allows clock to continue running when the instrument is switched off or power fails.

Gating Periods

Manual: Gating period is controlled by the user Start/Stop key. Accumulating results are displayed throughout the measurement and the end of measurement result is held until a new gating period is started.

Timed Single: Gating period is started by pressing the Start/Stop key and terminates at the end of the gating period set by the user. Accumulating results

are displayed throughout the gating period and the end of gating result is held until a new gating period is started.

Timed Repeating: Similar to Timed Single but when one timed gating period ends, a new identical period starts. This continues until the measurement is terminated by pressing the Start/Stop key. The measurement result displayed during any period is the final result of the previous period. There is no "deadtime" between consecutive periods.

Min Gating Period: 1 second.

Max Gating Period: 99 days, 23 hours, 59 minutes, 59 seconds.

Resolution: 1 second.

Error Measurements**Error Detection**

Ternary Interfaces: Bit and code errors are detected simultaneously.

Binary Interfaces: Bit errors only are detected.

Bit Errors: Detected by comparing input signal, after decoding, bit-by-bit with internally generated receiver reference pattern.

Receiver Reference Patterns: As transmitter test patterns except no Alternating Word.

Code Errors:

AMI: detected by looking for bipolar violations in data.
HDB3: detected by looking for violations of violations and runs of more than 3 zeros in the data.

Measurement Results

Error Count: The total number of errors during the gating period. The result is presented in integer format with a maximum of 15 digits and is updated every gating period.

Error Ratio: The total number of errors divided by the total number of bits in the gating period. At ternary interfaces, the number of bits is calculated from the standard rate selected. At binary interfaces, the number of clock cycles is counted. The result is presented in floating point format and is updated every second.

Format: $N.N \times 10^{-NN}$ for 1 to 100 errors;

$N.NN \times 10^{-NN}$ for 101 to 1000 errors;

$N.NNN \times 10^{-NN}$ for >1000 errors.

Error Intervals: Intervals of the real-time clock during which one or more errors occurred.

These can be selected to be errored seconds or deciseconds. The result is presented in integer format with a maximum of 15 digits and is updated every time an errored interval occurs.

Error Free Intervals:

Intervals, selected as seconds or deciseconds, during which no errors occurred. Updated every time an error free interval occurs.

Error Output

Selectable as output of either bit or code errors. One output pulse for each error.

Pulse Width: Nominally one clock period.

Level: Nominal ECL.

Impedance: Nominal low unbalanced to ground.

External Load: 50Ω to -2V dc coupled; 50Ω to ground ac coupled.

Connector: BNC, rear panel.

Alarm Duration Measurements

Alarm Durations

Power Loss: Total number of seconds the power was lost during the gating period.

AIS: Total number of seconds that the AIS (< 3 zeros in 2200 bits) was detected by the receiver during the gating period.

Sync Loss: Total number of seconds during the gating period, in which pattern sync was lost in the receiver.

Sync Loss Criteria:

Sync loss - error ratio worse than or equal to 1/9 over last 100 ms.

Sync Gain -

PRBS: < 10 errors in 90 clocks.

Word: < 10 errors in 170 clocks.

Rx Data Loss (Ternary Mode only): Total number of seconds during the gating period that no transitions were detected on the Rx Ternary Data In port.

Rx Data Loss Criterion: No transitions in the last 100 ms.

Rx Clock Loss: Total number of seconds during the gating period that no clock transitions were detected on the Rx Clock In port.

Rx Clock Loss Criterion: No transitions in the last 100 ms.

Tx Clock Loss: Total number of seconds during the gating period that no transitions were detected at the Tx Clock In port.

Tx Clock Loss Criterion: No transitions in the last 300 ms.

Slip Measurement

This measurement can be made when the receiver is set to receive a PRBS test pattern. A slip is defined as a phase shift of 1 or more bits of the data pattern with respect to the receiver reference pattern.

Slip Detection Criterion:

A slip is counted if $N + 64$ bits (where N is the PRBS radix number) pass during which the error pattern is of the same form as the selected PRBS.

Cumulative Slip Deciseconds:

Total number of slip deciseconds, divided by 10. A slip decisecond is a decisecond during which one or more slips occurred.

Expressed in seconds, to one decimal place.

Received Frequency or Offset Measurement

Binary Clock Frequency

Measurement Range: 1 kHz to 50 MHz.

Resolution: 1 Hz.

Accuracy: ± 3 ppm.

Ternary Data Clock Offset

The offset of the recovered clock with respect to the standard data rate.

Measurement Range: Fixed rates ± 999 ppm.

Resolution: 1 ppm.

Accuracy: ± 3 ppm.

Error Analysis

The error analysis is based on CCITT Rec G.821 and is derived from the bit error results.

% Unavailability: The error ratio is calculated over 1 second timed intervals during the gating period. An unavailable period begins when the error ratio is worse than 1×10^{-3} for 10 consecutive seconds. These 10 seconds are considered part of the unavailable time. The unavailable period ends when the error ratio is better than 1×10^{-3} for 10 consecutive seconds. These 10 seconds are considered part of the available time. **% Unavailability** is the ratio of the unavailable seconds to the total gating period expressed as a percentage. If AIS, Data Loss, Ext Clock Loss or Pattern Sync Loss is detected then this is considered as an error ratio worse than the availability threshold for error analysis calculations.

% Availability: The ratio of the available seconds to the total gating period expressed as a percentage.

% Error Seconds: The ratio of the errored seconds in the available time to the total number of seconds in the

available time, expressed as a percentage.

% Severely Errored Seconds: The ratio of the total number of available seconds with an error ratio worse than 1×10^{-3} to the total number of available seconds, expressed as a percentage.

% Degraded Minutes: Severely errored seconds are discarded from the available time and the remaining seconds are grouped into blocks of 60 seconds. Blocks which have an error ratio worse than 1×10^{-6} are called degraded minutes and **% degraded minutes** is the ratio of the total number of degraded minutes to the total number of 60 second blocks in the available time expressed as a percentage.

Long Term Mean Error

Ratio: Error ratio calculated for available time excluding severely errored seconds.

Error Distribution: This analysis classifies error seconds or error deciseconds containing 1 error, 2 to 10 errors, and more than 10 errors. The totals for each of these groups are presented for the full gating period, not just the available time.

Error Bursts: This analysis totals the number of error bursts which occur during the gating period. An error burst is defined as a group of >100 errors occurring in a time frame within the gating period. The time frame begins with the first error in the burst and ends ten error free intervals after the last

error in the burst. The error intervals can be selected as seconds or deciseconds.

Pass/Fail Tests: These tests allow the user to set thresholds against which the analysis results are compared. Any end-of-gating result which is worse than the threshold is indicated as a Fail. Thresholds which are not required can be turned off. An overall Pass result indicates that all the individual measurements have passed. An overall Fail indicates that at least one measurement result was worse than its respective threshold value.

Result Logging

Results can be logged to most standard HP-IB or RS-232-C 80-column printers.

HP-IB Interface

See Remote Control.
Talk-only mode.

RS-232-C Printer Interface

Port Configuration: DCE.

Handshakes:

Xon/Xoff (DC1/DC3): On/Off.

Enq/Ack: On/Off.

Bit Rate: 110, 150, 300, 600, 1200, 2400, 4800, 9600.

Parity: None/Even/Odd/1s/0s.

Bits per Character: Either 8 data bits and no parity bits or 7 data bits and a single parity bit. When the instrument is set to log graphically, the parity is automatically set to None.

Stop Bits: 1 or 2.

Connector: Female, rear panel.

Print Modes

Three modes are provided:

On-Demand: Prints time-of-day and selected set of results when Log On Demand key is pressed.

Text Mode: Logs time stamped events during gating and/or a user selected summary of measured results and alarm durations at the end of each gating period. A conditional printing trigger can be set so that printing only occurs if bit or code error count or ratio or the frequency offset exceeds a value selected by the user.

Graphic Mode: Available when gating repetitively. The Bit Error Ratio and Code Error Ratio or Recovered Clock Frequency Offset are plotted against an X-axis of time. One pair of points is plotted at the end of each gating period. The HP ThinkJet and QuietJet printers are recommended.

Remote Control

HP-IB Interface

IEEE standard 488, 1978.

Capability: SH1, AH1, T5, TE0, L4, LE0, SR1, RL1, PP0, DC1, DT0, C0. The HP-IB capability conforms to IEEE standard 728, 1982, for codes and formats.

Modes:

Addressable: An external controller has access to all the current results and alarms and can control all front panel functions except HP-IB address and power switch.

Talk-only: The HP 3784A outputs results to an external printer over HP-IB without an external controller.

RS-232-C Modem Interface

Port Configuration: DTE.

Connection: Hardwired or modem, dial-up or leased.

Duplex: Full or half (no half duplex in hardwired mode).

Handshakes:

Xon/Xoff (DC1/DC3): Full duplex only.

Rx Only: HP 3784A paces rate at which it receives data by sending Xon/Xoff.

Tx Only: Controller paces the rate at which it transmits data by sending Xon/Xoff.

Rx & Tx: As for both above.

Enq/Ack: On/Off.

DTR: On/Off (this choice is made available by setting an internal switch).

Bit Rate: 300, 600, 1200, 1800, 2400, 4800, 9600.

Selectable Data Rate

(controlled by CI signal from dual rate modem): High and low rates individually selectable from above list.

Parity: Even/odd/1s/0s.

Bits per Character: 7 data bits and one parity bit.

Stop Bits: 1 or 2.

Connector: Female, rear panel.

General

Power Supply

Voltage Range: Selectable, 90 to 126 V ac, nominally 115 V ac; 190 to 253 V ac, nominally 230 V ac.

Frequency Range: 48 to 66 Hz.

Power Consumption: 140 Watts.

Physical

Dimensions: 195 mm high, 335 mm wide, 475 mm deep.

Weight: 12 kg net; 14.5 kg shipping.

Environmental

Operating Temperature Range: 0 to 50°C.

Storage Temperature Range: -20 to +70°C.

Option 002 - Jitter Measurements

This option adds jitter generation and measurement at 2, 8 and 34 Mb/s to the standard instrument. Additional specifications for Option 002 follow. Some restrictions on the standard specification which apply when jitter measurements are in use are highlighted in the text.

Note: Option 002 cannot be fitted with Option 006 (64 kb/s measurements).

Transmitter

Clock

Internal Clock Range: Jitter can be added to the transmitter output at any of the standard fixed rates 2, 8 and 34 Mb/s, or, using the internal synthesizer in variable mode, within $\pm 10\%$ of 2.048, 8.448 and 34.368 Mb/s.

External Clock Range: When operating the transmitter from an external clock source while adding jitter, the external clock should be within $\pm 10\%$ of 2.048, 8.448 and 34.368 Mb/s. The correct jitter range for the external clock rate is selected automatically.

Intrinsic Jitter: Typically ≤ 0.020 UI pk-pk. (Measured with receiver set to Range 1, HP1 selected and jitter modulator switched on.) For optimum intrinsic jitter performance, the transmitter and receiver should either be used at identical bit rates, ie from the same clock source, or at rates differing by $> 1\%$.

Tx Reference Clock Output

The unjittered Transmitter Reference Clock is provided on a rear-panel port except in Through-data (Thrudata) jitter modulation mode (when the reference is available at the rear panel Selectable port – see transmitter, standard instrument).

Source: Internal or External clock.

Level: Nominal ECL.

Impedance: Nominal low.

External Load: 50Ω to $-2V$ dc coupled or 50Ω to ground ac coupled.

Connector: BNC.

Alternating Word

As standard. In addition, can be switched by internal modulation source.

Jitter Modulation

Jitter can be applied to any internally generated test pattern or to a signal applied in the Thrudata mode.

Figure 1

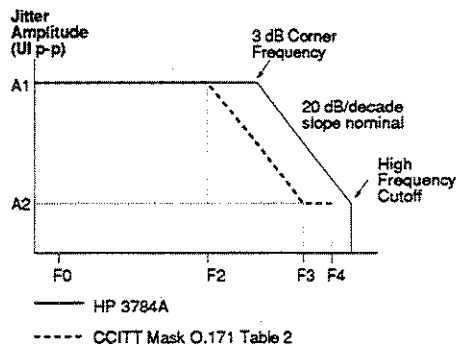

Nominal Bit Rate (kb/s)	704	2048	8448	34368
A1 (UI p-p)	—	10.0	10.0	10.0
A2 (UI p-p)	—	0.5	0.5	0.5
F0 (Hz)	—	2	2	2
F2 (kHz)	—	2.4	10.7	1.0
F3 (kHz)	—	45	200	20
F4 (kHz)	—	100	400	800
Corner Freq (kHz)*	—	13	50	210
Cut-off Freq (kHz)*	—	102	422	840

*Typical figures

The jitter may be internally or externally modulated.

In Thru data mode, jitter can be added to a ternary or binary data input signal, without altering its pattern, format or coding. For binary data, the receiver must also be supplied with the corresponding clock signal.

Internal Modulation

Figure 1 shows the typical range of jitter modulation amplitudes and frequencies available at each bit rate.

Max Jitter Amplitude:

10.10 UI p-p.

Min Jitter Frequency: 1 Hz.

Distortion at 1 kHz: Typically better than 30 dB (measured at the Rx Demod Jitter Out port for a jitter amplitude of 5.0 UI p-p).

Jitter Frequency Resolution:

- 1 to 500 Hz, in 1 Hz steps;
- 500 Hz to 5 kHz, in 10 Hz steps;
- 5 to 50 kHz, in 100 Hz steps;
- 50 to 500 kHz, in 1 kHz steps;
- 500 to 840 kHz, in 10 kHz steps.

Jitter Frequency Accuracy:

± 1.0%.

External Modulation

The test pattern can be jittered by a signal applied to the Ext Modulation In port.

Modulating Frequency

Range: Typically as shown in Figure 1 with F0 extended down to dc.

Max Input Voltage: 1.5 V p-p

(excessive voltage results in modulation distortion).

Max Jitter Amplitude: 10.10

UI p-p, depending on jitter frequency (as indicated by transmitter jitter amplitude display), see Figure 1.

Flatness: Nominally ± 0.3 dB (dc to 3 kHz).

Sensitivity: Nominal 10 UI/V (p-p figures at 5 Hz).

Impedance: Nominal 50Ω unbalanced to ground.

Connector: BNC.

Jitter Amplitude Accuracy

See Figure 2. The transmitter display rate determines the lowest frequency of jitter that can be measured within the quoted accuracy.

For internal modulation, the display rate automatically changes from Fast to Med for jitter modulation frequencies < 10 Hz.

For external modulation, the appropriate display rates should be selected for modulation frequencies in the following ranges:

- ≥ 10 Hz - Fast
- ≥ 1 Hz - Med
- ≥ 0.1 Hz - Slow

Figure 2

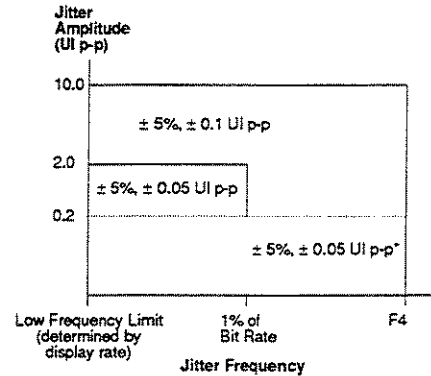

* 34 Mb/s: ± 5% +0.07 -0.03 UI p-p

Figure 3

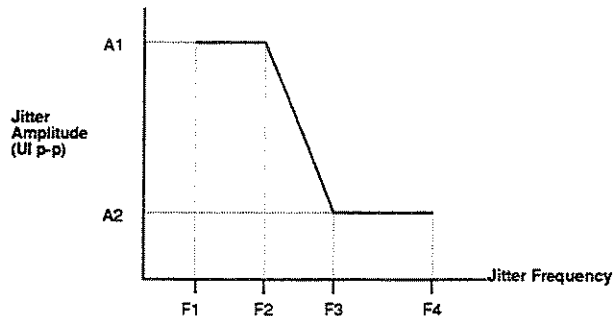

Nominal Bit Rate (kb/s)	704	2048	8448	34368
A1 (UI p-p)	—	1.5	1.5	1.5
A2 (UI p-p)	—	0.2	0.2	0.15
F1 (Hz)	—	20	20	100
F2 (kHz)	—	2.4 (0.093)	10.7 (0.4)	1.0
F3 (kHz)	—	18 (0.7)	80 (3)	10
F4 (kHz)	—	100	400	800

The values shown in () apply when the high Q system is selected.

Fixed Jitter Tolerance Masks

Five pre-programmed jitter tolerance masks with p-p jitter amplitudes and modulating frequencies in accordance with CCITT Rec G.823 Table 2/Fig 2, are provided covering 2, 8 and 34 Mb/s with high and low Q systems catered for. The masks can be used to measure tolerance to jitter amplitude at spot jitter frequencies (Spot Mask), or can be swept automatically in 20% frequency increments and decrements (Swept Mask). The values of jitter amplitude at each point on the masks are shown in Figure 3.

Programmable Masks

Jitter masks with between 2 and 6 breakpoints can be programmed by the user. Interpolation between breakpoints is linear on a log:log plot. The frequency values must lie within the limits shown for transmitter modulation shown in Figure 1.

Receiver

Jitter can be measured on the clock recovered from an input ternary data signal or on a binary clock input.

Reference Clock: This is derived internally from the input data/clock or can be supplied externally at the Rx Ref Clock In port.

Ternary HDB3 Data or Binary Clock Input:

Frequency Range: Restricted to ± 50 ppm of 2.048, 8.448 and 34.368 Mb/s when using the internal reference clock.

Binary Clock Input:

Frequency Range: Jitter can be measured on any binary clock signal in the range 2.048 to 34.368 Mb/s if an external reference clock is used.

Jitter Measurement Ranges

Display Range 1: 0.000 to 1.010 UI p-p (0.505 UI peak).

Display Range 10: 00.00 to 10.10 UI p-p (5.05 UI peak).

Jitter amplitude measurement ranges versus jitter frequency are based on CCITT Rec O.171 Table 3. The nominal measurement ranges for the Data Input and Clock Input are shown in Figure 4.

Note: The measurement range can be extended down to 0.1 Hz using an external reference clock.

Figure 4

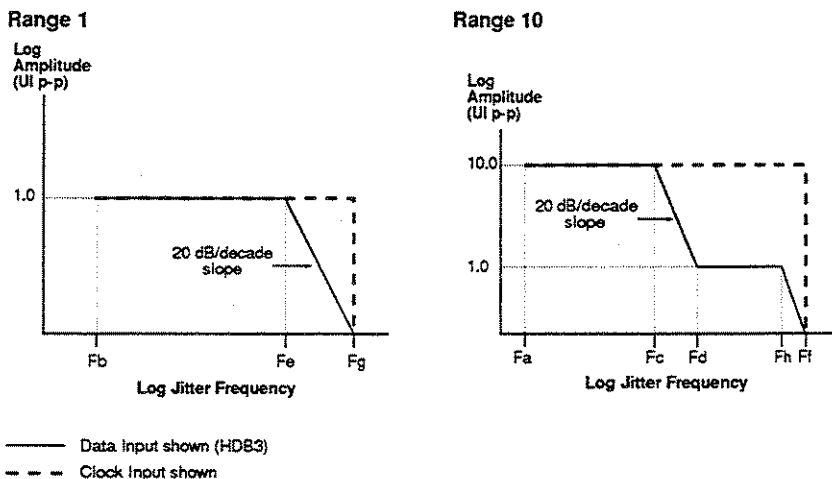

Nominal Bit Rate (kb/s)	704	2048	8448	34368
Fa (Hz)	—	10	10	10
Fb (Hz)	—	20	20	20
Fc (kHz)	—	2.4	10.7	1.0
Fd (kHz)	—	27	100	10
Fe (kHz)	—	30	120	240
Ff (kHz)	—	27	110	344
Fg (kHz)	—	100	400	800
Fh (kHz)	—	Ff	Ff	240

Measurement Accuracy

Peak-Peak: $\pm 4\%$ + additional error shown in Table 1 (a) and (b).

+ve Peak/-ve Peak: (without using the internal filters).

Range 1: $\pm 5\% \pm 0.01 \pm$ additional error. Shown in Table 1 (a).

Range 10: $\pm 5\% \pm 0.10 \pm$ additional error. Shown in Table 1 (b).

Note: For measurements where an external reference clock is required, the receiver display rate must be set according to the frequency of the measured jitter as follows to ensure the above accuracy:

- ≥ 10 Hz - Fast
- ≥ 1 Hz - Med
- ≥ 0.1 Hz - Slow

For measurements using the internal reference clock, the Fast rate is always selected.

The receiver display rate control is shared with the transmitter when the transmitter is modulated externally.

Measurement Filters

Three measurement filter combinations are available at each bit rate as specified in CCITT Rec O.171. These filters pre-shape the demodulated jitter signal before jitter amplitude measurement and before providing a demodulated jitter output at the rear-panel connector.

Selection Choices:

- Filters Off;
- Low Pass;
- High Pass 1 + Low Pass;
- High Pass 2 + Low Pass.

Note: All filters have a nominal 20 dB/decade slope.

Filter Cut-off Frequencies:

See Table 2.

Rx Reference Clock Port

This port can be selected as either the Output of the internal jitter measurement reference clock or used as an Input to supply an external reference clock to the jitter demodulator.

In the latter case, when using Range 1, correction of the phase offset of the reference clock with respect to the input ternary data or binary clock signal may be required by, for example, adjusting the relative cable lengths.

Table 1

Table 1 (a) Additional Error (Range 1) with any internal receiver filter

Nominal Bit Rate (kb/s)	704	2048	8448	34368
Any HDB3 Pattern	—	0.035 (0.035)	0.035 (0.035)	0.060 (0.035)
Clock Input	—	0.020 (0.01)	0.020 (0.01)	0.025 (0.01)

Figures in () are typical.

Table 1 (b) Additional Error (Range 10) with any internal receiver filter

Nominal Bit Rate (kb/s)	704	2048	8448	34368
Any HDB3 Pattern	—	0.23 (0.12)	0.23 (0.12)	0.25 (0.12)
Clock Input	—	0.20 (0.1)	0.20 (0.1)	0.25 (0.1)

Figures in () are typical .

Table 2

Table 2 Nominal 3 dB Corner Frequencies

Nominal Bit Rate (kb/s)	704	2048	8448	34368
High Pass HP1	—	20 Hz	20 Hz	100 Hz
High Pass HP2	—	18 kHz	80 kHz	10 kHz
Low Pass LP	—	100 kHz	400 kHz	800 kHz

Connector: BNC, rear panel.
Reference Clock Output Level: Nominal ECL.
Impedance: Nominal low unbalanced to ground.
External Load: 50Ω to -2V dc coupled or 50Ω to ground ac coupled.
Reference Clock Input Frequency Range: Nominal, 2.048 to 34.368 Mb/s.
Level: Nominal ECL.
Impedance: Unbalanced 50Ω nominal.
Termination: -2V.

Demodulated Jitter Output

The demodulated waveform appears at the rear panel Demod Jitter Output port after shaping by the measurement filters.

Bandwidth: As jitter measurement ranges after filtering has been applied.

Amplitude:

Range 1: 1.0 V/UI (p-p values).

Range 10: 0.1 V/UI (p-p values).

dc Content: Nominally ≤ 5 mV.

Accuracy: As measurement accuracy.

Impedance: Nominal low.

Connector: BNC, rear panel.

Measurement Input

When enabled this input can be used to make jitter amplitude and jitter hit measurements on a signal supplied from an external source. This allows the user to insert external filters between the Demodulated Jitter Output and the measurement circuits.

Impedance: Nominally 1 kΩ to ground.

Connector: BNC, rear panel.

Jitter Analysis

Time-varying jitter amplitude can be analyzed using the following measurements.

Max Peak-Peak: Records the maximum peak-peak jitter amplitude measured in a gating period.

Note: p-p measurements are intended for repetitive waveforms only.

Hit Count: Counts the number of times the measured jitter amplitude exceeds a threshold value set by the user.

Threshold Setting Range:

Range 1: 0.05 to 0.5 UI peak.

Range 10: 0.5 to 5.0 UI peak.

Hit Intervals: Counts the number of time intervals in which one or more jitter amplitude hits have occurred. The time interval can be set as a second or a decisecond.

Hit Free Intervals: Counts the number of time intervals in which no jitter amplitude hits have occurred.

Result Logging

Jitter results can be logged with error results to permit correlation of error activity with jitter amplitude. In addition there are two automatic jitter measurements which present results in the form of a graph on the external printer, as follows.

Automatic Jitter Tolerance Plot

The HP 3784A transmitter automatically steps through a range of jitter frequencies and at each frequency point increases the jitter amplitude until the onset of errors is detected by the HP 3784A receiver. The results are plotted as a graph of jitter tolerance against frequency.

Automatic Jitter Transfer Function Plot

The HP 3784A transmitter automatically steps through a range of jitter frequencies and at each frequency calculates the jitter gain as the ratio of the jitter amplitude measured by the HP 3784A receiver to the transmitted jitter amplitude. Values of transmitted jitter amplitude are obtained from an automatic calibration routine. The results are plotted as a graph of jitter gain expressed in dB against jitter frequency.

General

Weight: 13 kg net; 15.5 kg shipping.

Option 006 - 64 kb/s Measurements

This option adds the capability to generate and make measurements with test signals at 64 kb/s codirectional interfaces, coded in accordance with CCITT Rec G.703.

Note: Option 006 cannot be fitted with Option 002 (Jitter Measurements).

Transmitter

Codirectional Interface

Clock Source:

Internal Fixed Rate: 64 kb/s; accuracy, aging and offsets as for standard instrument.

External Clock Input: May be used for looped timing with Rx Ref Clock Out.

Pulse Shape: In accordance with CCITT Rec G.703 Fig 5/G.703.

Coding: In accordance with CCITT Rec G.703 Fig 4/G.703 with 8 and 16-bit words synchronized to the octet timing. The violation block marks the last bit in an octet.

Impedance: nominal 120 Ω balanced to ground.

Connector: 3-pin Siemens.

Receiver

Codirectional Interface

Pulse Shape: In accordance with CCITT Rec G.703 Fig 5/G.703.

Decoding: In accordance with CCITT Rec G.703 Fig 4/G.703.

Rate Tolerance: ± 120 ppm.

Clock: Recovered from codirectional signal.

Monitor Mode: Automatic gain control compensates for up to 30 dB of monitor point attenuation.

Impedance: Nominal 120 Ω balanced to ground.

Connector: 3-pin Siemens.

Error Analysis

Performed on the basis of error count thresholds rather than the error ratio thresholds used for higher bit rates. (See CCITT Rec G.821.)

Introduction

This section contains information and instructions required to prepare the HP 3784A for use. Included in this section are the initial inspection procedures, power and grounding requirements, fuse selection procedure, installation information and instructions on repacking for shipment.

Initial Inspection

WARNING

To avoid hazardous electrical shock, do not perform electrical tests when there are signs of shipping damage to any portion of the outer enclosure (covers, panels, meters).

Inspect the shipping container for damage. If the shipping container or cushioning material is damaged, it should be kept until the contents of the shipment have been checked for completeness and the instrument has been checked both mechanically and electrically. Procedures for checking the electrical operation are given in Section VIII of this manual. If the contents of the shipment are incomplete, if there is mechanical damage or defect, or if the instrument does not pass the electrical Performance Tests, notify the nearest Hewlett-Packard office. If the shipping container is also damaged, or the cushioning material shows signs of stress, notify the carrier as well as the Hewlett-Packard office. Keep the shipping materials for carrier's inspection. The Hewlett-Packard office will arrange for repair or replacement without waiting for claim settlement.

Contents

HP 3784A Transmission Analyzer
Power Cord
Operating /Calibration Manual
Remote Operating Manual (part number 03784-90001)
RS-232-C Cable (Part No. 5060-4461)
RS-232-C Test Plug (Part No. 5060-4462)

Preparation For Use

Power Requirements

The HP 3784A requires a power source of 115V (+10%, -22%) or 230V (+10%, -15%), 48 - 66Hz single phase. Total power consumption is approximately 160VA.

Line Voltage Selection

The line voltage is selected by the rear panel switch labelled 120V/240V, 48-66Hz.

CAUTION

Before connecting this instrument to a power outlet ensure that the voltage selector is correctly set for the voltage of the power source and a fuse of the correct rating is fitted.

Table 7-1. Fuses

Nominal Line	Fuse Rating	HP Part Number
120V	3A	2110-0381
240V	5A	2110-0304

Power Cable

This instrument is equipped with a three-wire power cable. When connected to a power outlet, this cable grounds the instrument case. The type of power cable shipped with each instrument depends on the country of destination. Refer to Figure 7-1 for part numbers of the power cable and plug configurations available. The number shown below each plug is the Hewlett-Packard part number of a power cord equipped with that plug. If the appropriate power cord is not included with the instrument, notify the nearest Hewlett-Packard Sales and Service Office and a replacement will be provided.

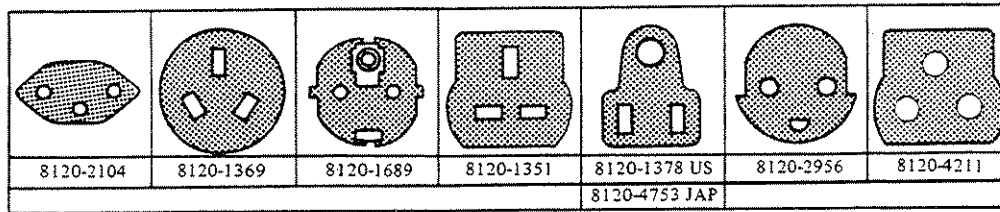

Figure 7-1 Power Receptacles

The colour code used in each power cable is given below:

Line	Brown
Neutral	Blue
Ground	Green/Yellow

HP 3784A Display Contrast Adjustment

An adjustment R2 on the A11 Assembly allows the contrast of the HP 3784A display to be set. It is not necessary to remove instrument covers to adjust R2. A suitable adjusting tool can be inserted through the perforated right hand side cover (approximately 50cm in and down from top of front panel). R2 is the blue coloured, square shaped potentiometer on A11.

Internal Battery

WARNING

DO NOT INCINERATE OR MUTILATE THE BATTERY. IT MIGHT BURST OR RELEASE TOXIC MATERIALS CAUSING PERSONAL INJURY.

The lithium battery on A11 used as a power supply for the non-volatile memory, should be checked annually. Life expectancy of the battery is approximately 5 years. (Part Number 1420-0177)

Battery Failure

If the battery fitted on the A11 Assembly fails the HP 3784A responds by displaying the following at power-up.

NON VOLATILE MEMORY FAILURE
 Instrument Type: HP 3784A
 Default settings assumed.
 Press any key to continue.

Battery Replacement

- a. Switch off the HP 3784A and remove the power cord.
- b. Remove the HP 3784A top cover.
- c. Unsolder and remove the faulty Battery from the A11 Assembly.
- d. Solder a new battery in place of the old one, ensure that the polarity connection is correct.
- e. Replace the instrument top cover.

Operating Environment

Temperature	The instrument may be operated in temperatures from 0°C to +55°C.
Humidity	The instrument should be protected from temperature extremes which may cause condensation within the instrument.
Altitude	The instrument may be operated at altitudes up to 4600m (15,000ft).
Air flow	The air intake to the instrument is via a fan mounted on the rear panel. The air exhaust is via the perforated side panels. To provide adequate cooling, an air gap of approximately 3 inches should be maintained around the instrument. The fan filter should be removed from the instrument and cleaned in hot soapy water every six months or more frequently if the instrument is operated in a hostile environment.

Storage and Shipment

Environment

The instrument may be stored or shipped in environments within the following limits:

Temperature	-40°C to +75°C
Altitude	15,300m (50,000ft)

The instrument should also be protected from temperature extremes which may cause condensation within the instrument.

Rack Mounting

A Rack Mount Kit (option 061) is available for use with the HP 3784A and can be purchased from your nearest Hewlett-Packard Office. To obtain a retro-fittable Rack Mount Kit, order HP Part Number 03771-60105. Note: This Rack Mount Kit does not give front-panel access to the rear-panel connectors.

Instructions on conversion to rack mounting are included with the rack mount kit and are also reproduced on the following page.

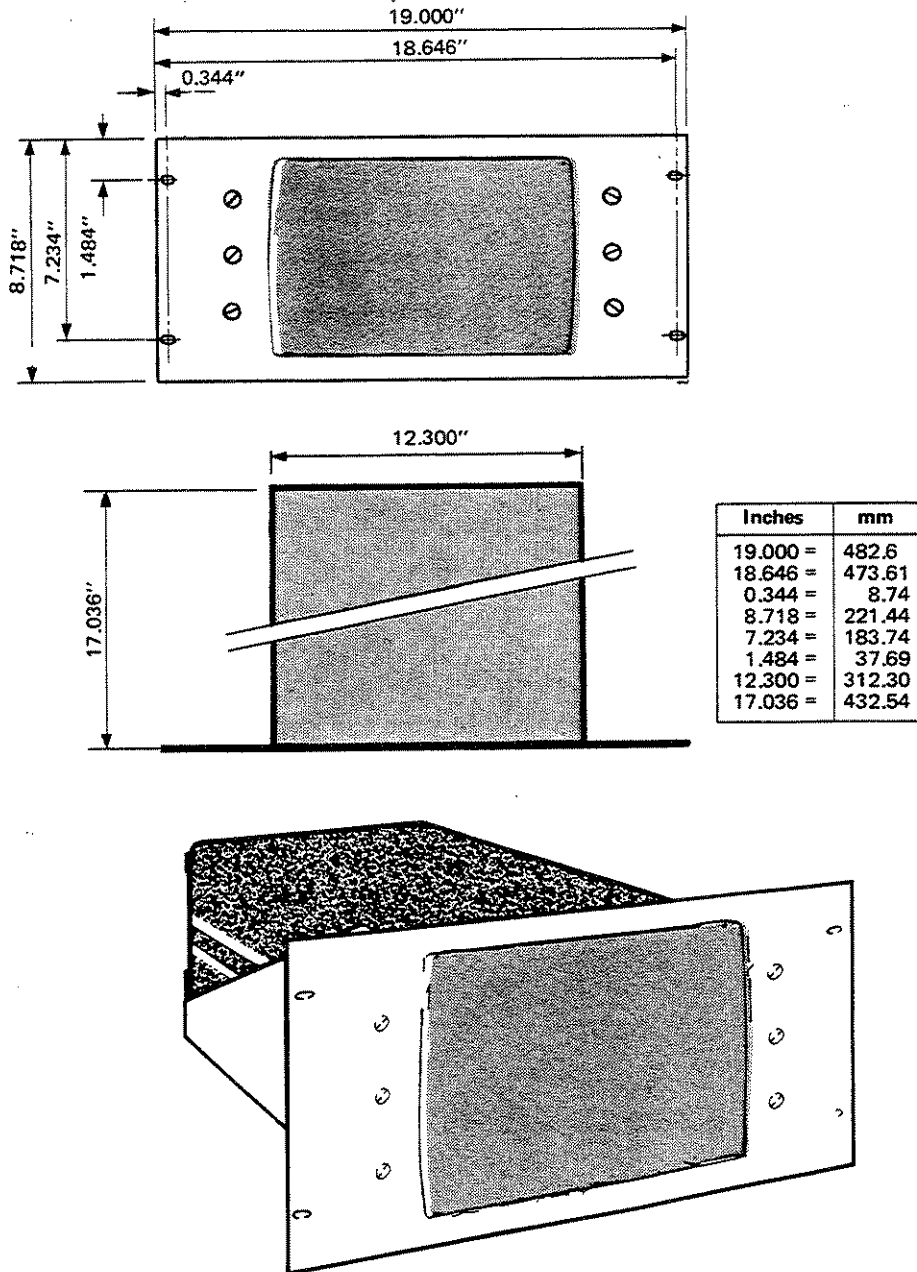

Figure 7-2 Rack Mounting

RETRO-FIT INSTRUCTIONS FOR RACK MOUNTING

If it is required to rack mount this instrument, order Rack Mount Kit HP Part Number 03771-60105. Parts relevant to rack-mounting this instrument, which are contained in this kit, are listed in Table 1.

Table 1 Rack Mount Kit Contents

Description	HP Part Number	Quantity
Rack Front Panel	03771-20056	1
Rack Tray	03770-11160	1
Screw	2940-0115	6
Nut	2950-0004	6
Washer-Lock	2190-0060	6
Screw	2360-0133	2
Washer-Flat	3050-0010	2
Washer-Lock	2190-0006	2
Washer-Flat	3050-8735	6

Discard all other parts contained in kit

Retro-fitting Procedure

1. Ensure that the instrument is switched-off and the power cord is disconnected.
2. Referring to Figure 1, remove the push-fit hub cover (MP5) from both sides of the instrument. (Finger pressure only is required to unclip MP5.) Discard the hub covers.
3. Remove the three locating screws on each side of the handle.
4. Remove and discard the handle (MP4), springs (MP3) and gear rings (MP1).
5. Re-locate the gear hubs (MP2) -- without screws -- to their original locations. (These parts act as spacers between the instrument frame and the rack tray shown in Figure 2.)
6. Locate the instrument into rack tray. Ensure that instrument rubber feet locate into eccentric slots in rack tray and gear hubs (MP2) line-up with holes at side of rack tray.
7. Retain rack tray to instrument by fixing screws (Part No. 2360-0133) through side of rack tray into centre of gear hub (MP2).
Do not tighten screws.
8. Mount rack front panel (MP10) onto rack tray, using six sets of screws, lock washers and nuts. (Note: the rack front panel is asymmetrical and will only fit in one position.)
9. Tighten all screws.

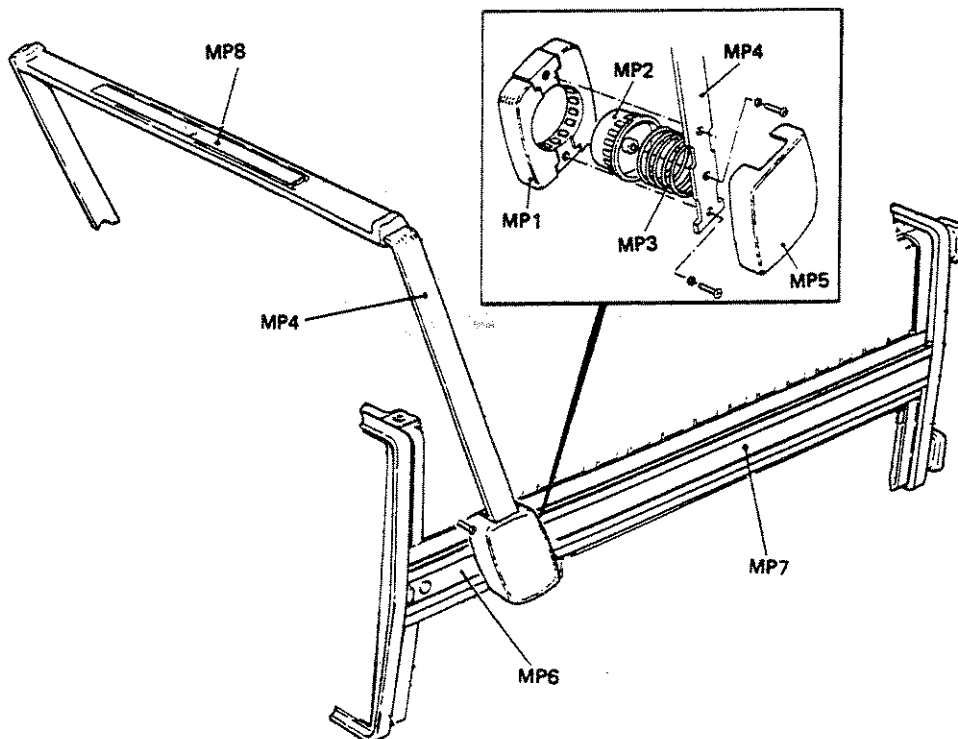

Figure 1 Hardware Details

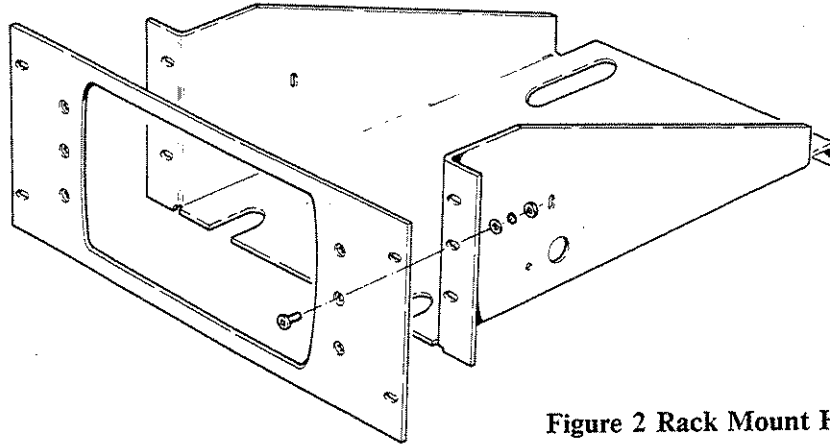

Figure 2 Rack Mount Hardware

Packaging

Tagging For Service

If the instrument is being returned to Hewlett-Packard for service, please complete one of the blue repair tags located at the front of the Operating and Calibration Manual and attach it to the instrument.

Original Packaging

Containers and material identical to those used in the factory are available through Hewlett-Packard offices. If the instrument is being returned to Hewlett-Packard for servicing, attach a tag indicating the type of service required, return address, model number, and full serial number. Also mark the container "FRAGILE" to ensure careful handling. In any correspondence, refer to the instrument by model number and full serial number.

Other Packaging

The following general instructions should be used for repacking with commercially available materials:

- (a) Wrap instrument in heavy paper or plastic. (If shipping to Hewlett-Packard office or service center, attach a tag indicating type of service required, return address, model number and full serial number.)
- (b) Use strong shipping container. A double-walled carton made of 350-pound test material is adequate.
- (c) Use a layer of shock absorbing material 70 to 100mm (3 to 4 inches) thick around all sides of the instrument to provide firm cushioning and prevent movement inside the container. Protect the control panel with cardboard.
- (d) Seal shipping container securely.
- (e) Mark the shipping container "FRAGILE" to ensure careful handling.
- (f) In any correspondence, refer to instrument by model number and full serial number.

Hewlett-Packard Interface Bus (HP-IB) Installation

This section contains information and instructions on the installation of the HP 3784A Transmission Analyzer into a Hewlett-Packard Interface Bus (HP-IB) system.

The HP-IB is Hewlett-Packard's implementation of the IEEE Standard 488-1978 (Digital Interface for Programmable Instrumentation). This standard defines a physical interface and protocol which enables the remote control of instrumentation systems.

Connection To The HP-IB

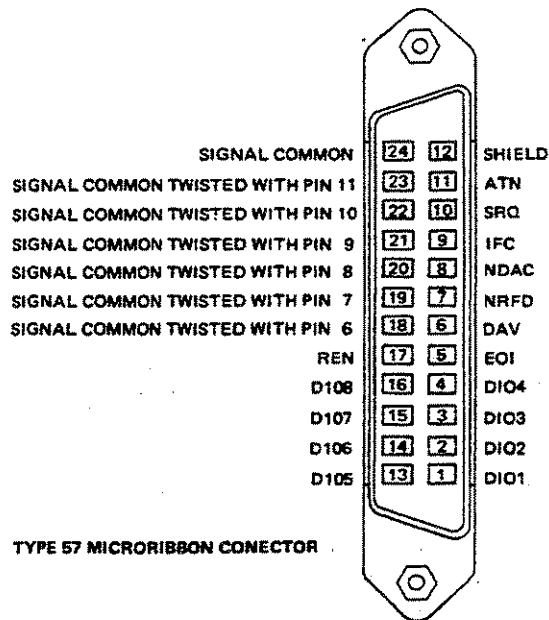

Figure 7-3 HP-IB (rear panel) Connector

The HP-IB connector on the rear panel of the HP 3784A provides the physical interface to connect the HP 3784A into an HP-IB system. Figure 7-3 illustrates the connector pin configuration.

HP-IB Cables

Devices in the HP-IB system may be interconnected in any suitable arrangement (star, delta etc) using the HP-IB cables listed in Table 7-2 provided the following restrictions are obeyed.

Table 7-2. HP-IB Interface Cables

HP-IB Part Numbers	Cable Lengths
HP 10833A	1 meter (3.3ft)
HP 10833B	2 meters (6.6ft)
HP 10833C	4 meters (13.2ft)
HP 10833D	0.5 meters (1.6ft)

To achieve design performance, restrictions are placed on the length of HP-IB system cable as follows:

- (a) The total length of HP-IB cable used to interconnect devices on the HP-IB must not exceed 2 meters (6.6ft) times the number of devices in the system
- (b) The maximum accumulative length of HP-IB cable for any HP-IB system is 20 meters (65.6ft).

RS-232-C Interface Installation

The HP 3784A can be connected to an RS-232-C interface and operated remotely. The HP 3784A Modem port is configured as Data Terminal Equipment (DTE). The HP 3784A Printer port is configured as Data Communications Equipment (DCE).

Connection to the RS-232-C System

The RS-232-C Modem connector on the rear panel of the HP 3784A provides the physical interface to connect the HP 3784A to an RS-232-C system. Figure 7-4 illustrates the connector pin configuration.

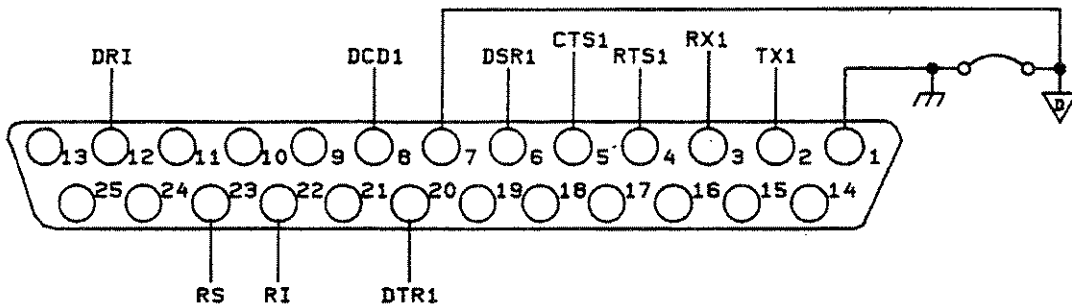

Figure 7-4 RS-232-C Modem Connector

The RS-232-C Printer connector on the rear panel is used when an external printer is desired for data logging. Figure 7-5 illustrates the pin configuration.

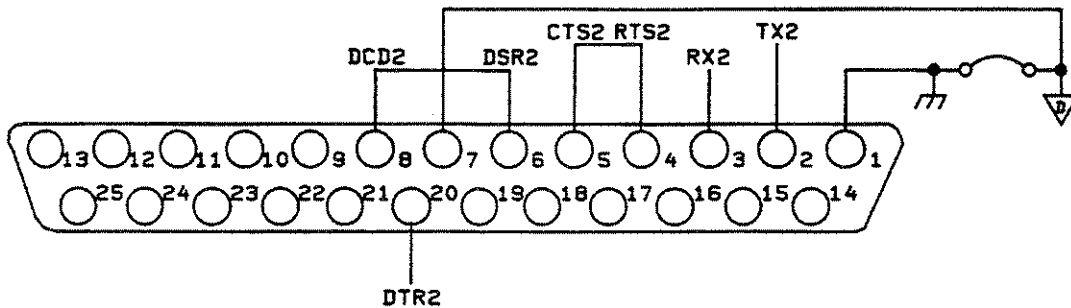

Figure 7-5 RS-232-C Printer Connector

Logic Levels

The RS-232-C functions are ON when the voltage at the receiver is more positive than +3volts and OFF when it is more negative than -3volts. The function is not defined in the transition region between +3volts and -3volts.

RS-232-C Remote Control

To use the HP 3784A remotely over the RS-232-C interface, refer to the HP 3784A Remote Operation manual (part number 03784-90001).

8.1 Introduction

This section contains procedures which test the instrument's electrical performance using the specifications listed in Section 6 as the performance standards. Each test is self contained and therefore may be performed individually or in any order. The sequence in which the tests are listed however, is the sequence recommended for complete performance testing.

8.2 Equipment Required

The equipment required to complete the Performance Tests is listed in Table 8-1. The individual equipment required for each test is listed within the test. Any equipment that satisfies the critical specifications given in the table may be substituted for the recommended model(s).

Table 8-1. Recommended Test Equipment

Instrument	Critical Specification	Model
Frequency Synthesizer	Sinewave to 50MHz, 9 digit resolution	HP 3335A
Universal Counter	Frequency Measurement, AC/DC coupling	HP 5335A
Pulse Generator	1kHz to 50MHz, Minimum Pulse Width 10ns	HP 8116A
Oscilloscope	275MHz Bandwidth, Dual Trace *	
Programmable Signal Source	Sine, Square & Triangle Output, 1MHz - 50MHz	HP 8165A
Attenuator	0 - 99dB in 1dB intervals	HP 3750A
Cable	480ft Belden cable	
Bal to Unbal Converter	120 ohm Balanced/75 ohm Unbalanced	HP 15508C
Computer	HP Series 200/300	
Power Supply	0 - 20V DC	HP 6284A
Voltmeter	> 4 digit resolution	HP 3478A
Pulse Shape Network	See Test 8-28	
Pattern Generator/Error Detector	See Test 8-31	
Termination Network	See Test 8-32	
Cable	120 ohm bal/BNC, See Test 8-32	
Cable	120 ohm bal/120 ohm bal	HP 15512A
Blocking Capacitors (2)	Unique	HP 10240B
75 ohm Termination (2)	BNC	HP 15522A

*Note: The Oscilloscope waveform illustrations in this Section were obtained using an HP 54100D Digital Oscilloscope. If the Option 002 Performance Tests require to be completed, it is recommended that an Analog Oscilloscope is used to allow the Jitter waveforms to be viewed clearly.

8.3 Test Record

The results of the Performance Tests may be recorded on the Test Record at the end of the procedures. The Test Record lists all of the test specifications and their acceptable limits. The results recorded at incoming inspection can be used for comparison in periodic maintenance, when trouble shooting, and after repairs or adjustment.

8.4 Calibration Cycle

This instrument requires periodic verification of performance. Depending on use and environmental conditions, the instrument should be checked, using this performance test procedure at intervals of approximately one year.

8.5 Performance Test Contents

The Performance Test Contents provide a list of the Performance Tests in the order in which they are presented together with page number references. This is located at the front of the manual.

8.6 Operation Verification

The Operation Verification procedure is provided in the HP 3784A Service Manual. This procedure is designed as an overall troubleshooting aid. For basic operational checks, see Self Tests.

8.7 Self Tests

Successful completion of the Self Tests described in Section 2 provides a high confidence level that the instrument is functioning correctly.

8.8 Instrument Default Settings

The Performance Test procedures require the HP 3784A to be set to its Default Settings so that the instrument is in a pre-defined state at the beginning of each test.

To set the HP 3784A to its Default Settings,

1. Select Page 1 Preset Panel, using the PAGE keys. (Note: Option 002 will display [PresetPanel]).
2. Using the CURSOR POSITION and UPDATE keys, set the HP 3784A to Function [RECALL FROM] Panel Memory [0].
3. Press the **EXEC** key. The display will blank momentarily, indicating that the panel has been recalled. The HP 3784A will now be set to its Default Settings.

8.9 External Clock

DESCRIPTION

A signal from an External frequency source may be used as the reference clock for internal pattern generation. This test verifies that pattern generation is possible through the specified external clock frequency range. The sensitivity of the CLOCK IN port to different input levels and the TX CLOCK OUT Mark : Space ratio are also checked.

SPECIFICATION

External Clock Frequency Range	1 kHz - 50 MHz
Sensitivity	Better than 500 mV p - p
Amplitude	5 V p-p (within limits of ± 5 V)
Minimum Input Pulse Width	10% pulse or space width 1kHz-10MHz 10 ns pulse or space width 10MHz-50MHz

The transmitter clock output duty cycle is dependent on the external input duty cycle, unless the instrument is Option 002 and jitter generation is employed. Then it is always 50:50.

TEST EQUIPMENT

Frequency Synthesizer	HP 3335A
Universal Counter	HP 5335A
Pulse Generator	HP 8116A

PROCEDURE

1. Connect the equipment up as shown in Figure 8-1.

NOTE : For Option 002 instruments, Connect the Counter to the rear panel TX REF CLOCK OUT instead of the front panel TX CLOCK OUT.

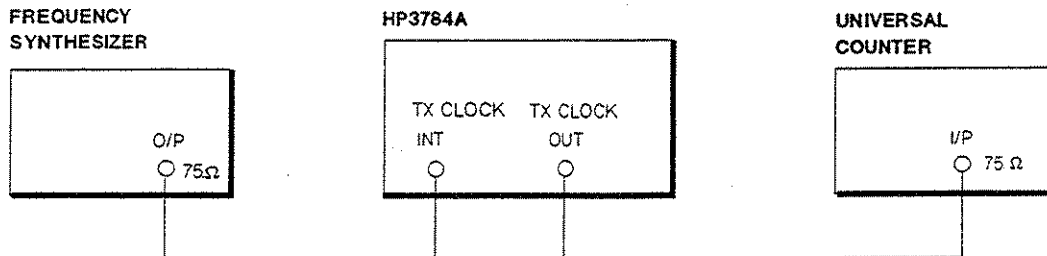

Figure 8-1 External Clock Test Set-up

2. Select HP 3784A Page 1 Preset Panel: and set to Function [RECALL FROM] Panel Memory [0]. Press the **EXEC** key to set instrument to its Default Settings.

NOTE: Option 002 Instruments. Select Page 12 Self Test: and set to Function [TYPE & REVISION] Instrument Type 3784A [Standard]

3. Select Page 2 Tx Setup and set to Clock [EXT].
4. Set the Frequency Synthesizer amplitude to -3.8dBm and the frequency to 1 kHz.

Verify the HP 3784A TX CLOCK IN led is on and the frequency reading on the Universal Counter display is 1000 ± 1 Hz. Check the Duty Cycle reading on the Universal Counter is between 44 and 56 %.

5. Set the Synthesizer amplitude to +11dBm and verify the TX CLOCK IN led is still on. Check the frequency reading on the Universal Counter is still 1000 ± 1 Hz.
6. Set the Frequency Synthesizer amplitude to +5.7dBm and the frequency to each value shown in Table 8-2. For each setting, verify:

- the HP 3784A TX CLOCK IN led is on
- frequency value is displayed correctly on Page 2 Tx Setup Clock[EXT].
- the reading on the Universal Counter is correct
- the Duty Cycle on the Universal Counter is correct

Table 8-2. External Clock Frequency

Frequency Synthesizer Setting	HP 3784A Clock [EXT] (Page 2) (Hz)	Universal Counter Reading (Hz)
1 kHz	1000 ± 2	1000 ± 0.001
10kHz	10000 ± 2	10000 ± 0.01
100kHz	100000 ± 2	100000 ± 0.1
1MHz	1000000 ± 4	$1.0E6 \pm 1$
10MHz	10000000 ± 31	$10.0E6 \pm 10$
50MHz	50000000 ± 151	$50.0E6 \pm 50$

7. Disconnect the Frequency Synthesizer.
8. Now connect the Pulse Generator to the HP 3784A TX CLOCK IN port.
9. Set the Pulse Generator output level to 1 V p-p and select Variable Pulse Width Mode.

10. Set the Pulse Generator output frequency and pulse width to the values shown in Table 8-3.

For each setting, verify the TX CLOCK IN led is on and the reading on the Universal Counter is correct.

Table 8-3. External Clock - Variable Pulse Width

Pulse Generator Frequency Setting	Pulse Generator Width Setting	Universal Counter Reading (Hz)
1kHz	100 μ s	1.000 E3 \pm 30
100kHz	1 μ s	100.00 E3 \pm 5 E3
1MHz	100ns	1.000 E6 \pm 50 E3
10MHz	10ns	10.000 E6 \pm 500 E3
20MHz	10ns	20.000 E6 \pm 1 E6
50MHz	10ns	50.000 E6 \pm 2.5 E6

11. Disconnect all test equipment

8.10 Internal Clock and Frequency Offset

DESCRIPTION

In the HP 3784A there are two types of Internal Clock generation; generation at the Standard Clock Rates and generation at a Variable Rate within a specified range. This test verifies the clock rate and checks the frequency offset circuitry.

SPECIFICATION

Standard Rates..... 704kHz, 2048kHz, 8448kHz and 34368kHz
 Variable Clock Range 1 kHz - 50 MHz
 Accuracy \pm 3 ppm
 Frequency Offset..... \pm 99 ppm
 Clock Duty Cycle (50 \pm 6)%
 Aging Typically \pm 1 ppm / year

TEST EQUIPMENT

Universal Counter HP 5335A
 Oscilloscope See Table 8-1

PROCEDURE

1. Connect the HP 3784A TX CLOCK OUT port to the Universal Counter as shown in Figure 8-2.

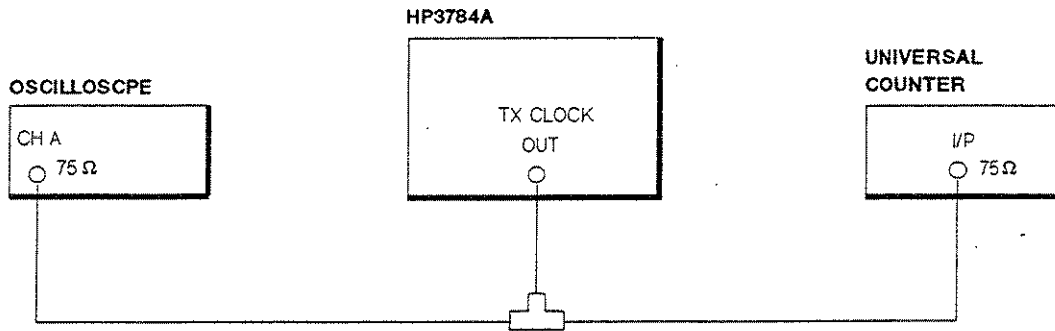

Figure 8-2 Internal Clock Test Set-up

2. Select HP 3784A Page 1 Preset Panel: and set to Function [RECALL FROM] Panel Memory [0]. Press the **EXEC** key to set instrument to its Default Settings.

Standard Rates

3. Select Page 2 Tx Setup on the HP 3784A and set the Clock [STD RATE] [] field to the settings given in Table 8-4. Verify on the counter that frequency readings and duty cycle are as shown in Table 8-4. Use the Oscilloscope for duty cycle at 34MHz.

Table 8-4. Standard Rate Clock Outputs

HP 3784A Clock Rate	Universal Counter Reading Hz		Duty Cycle %	
	Lower	Upper	Lower	Upper
[STD RATE] [704KHz]	703997	704003	44	56
[2MHz]	2047994	2048006	44	56
[8MHz]	8447976	8448024	44	56
[34MHz]	34367898	34368102	44	56

Variable Clock

To verify the HP 3784A Clock Synthesizer accuracy, set-up resolution and the Clock Output Duty Cycle over each of the six frequency bands:

- 1kHz to 312kHz in 100Hz steps
- 312kHz to 3126kHz in 1kHz steps
- 3126kHz to 6252kHz in 2kHz steps
- 6252kHz to 12504kHz in 4kHz steps
- 12504kHz to 25008kHz in 8kHz steps
- 25008kHz to 50016kHz in 16kHz steps

- On Page 2 Tx Setup select Clock [VAR]. Use the CURSOR POSITION **NEXT** and **PREV** keys to set the frequency to the values shown in Table 8-5.
- For each of the Clock [VAR] selections verify the clock frequency accuracy on the Universal Counter and verify the duty cycle on the Oscilloscope display.

Also check that the HP 3784A SYNTH UNLOCK led illuminates each time a new frequency is selected. It should extinguish when this frequency is achieved.

Table 8-5. Variable Clock

Page 2 Tx Setup Clock [VAR] (KHz)	Universal Counter Frequency Reading (Hz)
10.1	10100
150.1	150100
2001.0	2001000 ±6
4322.0	4322000 ±12
10004	10004000 ±30
17008	17008000 ±51
25008	25008000 ±75
50016	50016000 ±150

Clock Offset

The Frequency Offset circuitry applies to all internal clock rates and so it is sufficient to verify the frequency offset values at Standard Rate 34.368 MHz only.

- Select Page 2 Tx Setup and set to Clock[STD RATE][34 MHz]. Set the Offset Frequency to each of the values shown in Table 8-6.

Verify the TX CLOCK OUT accuracy on the Universal Counter.

Table 8-6. Frequency Offset

Frequency Offset (ppm)	Frequency Reading Lower (Hz)	Frequency Reading Upper (Hz)
-99	34 364 495	34 364 701
-20	34 367 211	34 367 415
-5	34 367 726	34 368 070
0	34 367 898	34 368 102
6	34 368 104	34 368 308
50	34 369 616	34 369 820
99	34 371 300	34 371 504

- Disconnect all test equipment

8.11 Binary Clock and Data Outputs

DESCRIPTION

This test verifies the HP 3784A transmitter Clock and Data Output for correct TTL/ECL levels and duty cycle/mark-space ratio over the instrument clock range.

SPECIFICATION

Format..... Clock and NRZ data.
Level TTL or ECL levels selectable
Clock Duty Cycle (50 ± 6)%
Phasing Clock Normal or Inverted selectable

TEST EQUIPMENT

Oscilloscope See Table 8-1
Universal Counter HP 5335A
Blocking Capacitors 2 X HP 10240B

PROCEDURE

1. Select HP 3784A Page 1 Preset Panel: and set to Function [RECALL FROM] Panel Memory [0]. Press the key to set instrument to its Default Settings.
2. Select Page 2 Tx Setup and set to the following:

2 Tx Setup:	Data Out [BINARY][TTL]
	Clock [STD RATE][2 MHz] Offset [+0]ppm
	Pattern [WORD][_2]Bit [10]
	Er Add (bit) [OFF] Clock Out [NORM]

3. Connect the HP 3784A, 75 ohm, TX DATA OUT port to Channel A of the Oscilloscope and TX CLOCK OUT port to Channel B. Terminate both in 75 ohms.

Set the Oscilloscope to trigger on Channel A.

4. Verify the Clock duty cycle is (50±6)% and the signal levels are as shown in Figure 8-3, typically $V_L = 0V$ and $V_H = 3V$.

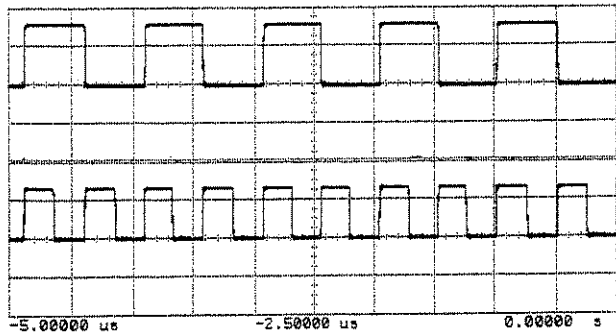

Ch. 1 = 2.000 volts/div Offset = 0.000 volts
 Ch. 2 = 2.000 volts/div Offset = 0.000 volts
 Timebase = 500 ns/div Delay = 0.00000 s

Trigger mode : Edge
 On Pos. Edge on Chan1
 Trigger Levels
 Chan1 = 288.0 mvolts
 Holdoff = 70.000 ns

Figure 8-3 Binary Clock and Data Outputs (TTL)

5. Set to Clock Out[INV]. Verify the clock signal polarity changes.
6. Now connect the HP 3784A, 75 ohm, TX DATA OUT and TX CLOCK OUT ports through blocking capacitors to Channels A and B respectively, terminating the input in 75 ohms.
7. Set the HP 3784A to Data Out [BINARY][ECL] and check the signal levels on the Oscilloscope are as shown in Figure 8-4 , typically $V_L = 1.85V$ and $V_H = -0.55V$.

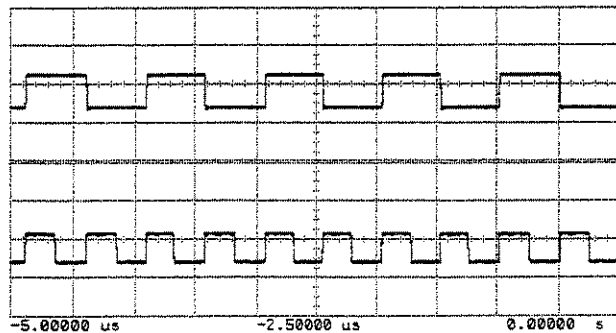

Ch. 1 = 2.000 volts/div Offset = 0.000 volts
 Ch. 2 = 2.000 volts/div Offset = 0.000 volts
 Timebase = 500 ns/div Delay = 0.00000 s

Trigger mode : Edge
 On Pos. Edge on Chan1
 Trigger Levels
 Chan1 = -500.0 mvolts
 Holdoff = 70.000 ns

Figure 8-4 Binary Clock and Data Outputs (ECL)

8. Disconnect the HP 3784A, 75 ohm, TX DATA OUT and TX CLOCK OUT ports from the Oscilloscope and reset the HP 3784A to Data Out [BINARY][TTL].

9. Connect the HP 3784A, 75 ohm, TX DATA OUT port to the Universal Counter Channel A. Verify the frequency count is 1.024 ± 0.003 MHz. (The "10" WORD data is NRZ so the count is half the clock rate).

10. Now select Clock[VAR] and set frequency to the values shown in Table 8-7.

Verify the Universal Counter display reading. (The data rate is half the clock rate because the data is NRZ).

NOTE : Use the Oscilloscope to measure the duty cycle at 50000kHz setting.

Table 8-7. TTL Binary Data Output

Clock [VAR] Frequency (kHz)	Universal Counter Reading (Hz)	
	Lower	Upper
1000	499 998	500 002
10000	4 999 985	5000 015
50000	24 999 925	25 0000 75

11. Disconnect all test equipment

8.12 Transmitter n-Bit Programmable Word

DESCRIPTION

The n-Bit Programmable Word generation is checked bit by bit. "n" is selectable between 1 and 16.

SPECIFICATION

A repeating n-Bit word pattern is generated at the HP 3784A Transmitter. n is selectable between 1 and 16.

TEST EQUIPMENT

Universal Counter HP 5335A

PROCEDURE

1. Select Page 1 Preset Panel on the HP 3784A and set the instrument to its Default Settings.
2. Connect the HP3784A, 75 ohm, TX DATA OUT port to the Universal Counter (terminated in 75 ohms, AC coupled).

3. Select Page 2 Tx Setup and set as follows:

```

2 Tx Setup:      Data Out [BINARY][TTL ]
Clock [STD RATE][ 2 MHz] Offset [ +0]ppm
Pattern [WORD][_2]Bit [10      ]
Er Add (bit) [OFF ]      Clock Out [NORM]
    
```

4. For each WORD in Table 8-8 below, verify the reading on the Universal Counter.

Table 8-8. Transmitter n-Bit Programmable Word

Pattern [WORD] [n]	Word Bits []	Universal FREQ A Counter Reading kHz
2	10	1024
3	100	682
4	1000	512
5	10000	409
6	10 0000	341
7	100 0000	292
8	1000 0000	256
9	10000 0000	227
10	10 0000 0000	204
11	1000 00000000	186
12	1000 0000 0000	170
13	1 0000 0000 0000	157
14	10 0000 0000 0000	146
15	100 0000 0000 0000	136
16	1000 0000 0000 0000	128
16	1010 1010 1010 1010	1024
16	0101 0101 0101 0101	1024

5. Disconnect all test equipment

- Now connect the equipment as shown in Figure 8-5.

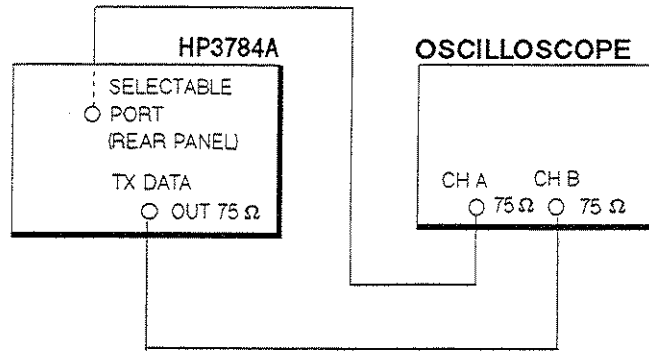

Figure 8-5 Transmitter Pattern Trigger Test Set-up

Set the Oscilloscope to trigger on Channel A.

- Select HP 3784A Page 2 Tx Setup and set to the following:

```

2 Tx Setup:      Data Out [BINARY] [TTL ]
Clock [STD RATE] [ 2 MHz] Offset [ +0] ppm
Pattern [WORD] [_6] Bit [100000 ]
Er Add (bit) [OFF ]      Clock Out [NORM]
  
```

- Check the Oscilloscope display is as shown in Figure 8-6.

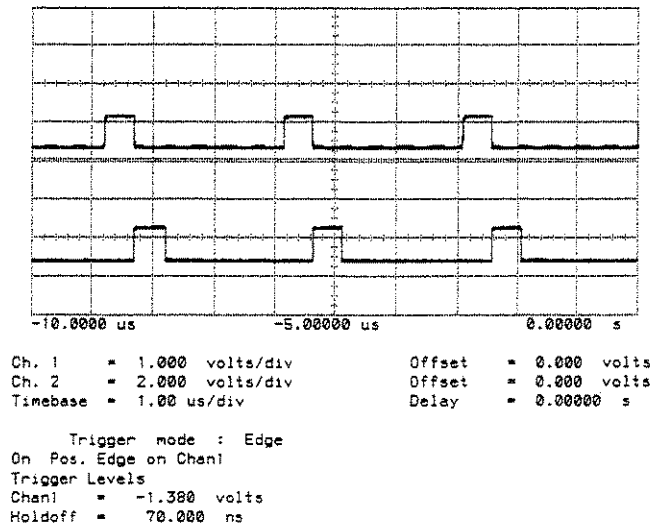

Figure 8-6 Pattern Trigger Output (6-Bit Word)

8. Select Page 10 Rear Panel Ports and set to Selectable Port[RX CLOCK OUT].
9. Connect HP 3784A TX CLOCK OUT port to RX CLOCK IN port and Rear Panel SELECTABLE port to Universal Counter (Input A terminated in 50 Ohms, AC coupled).
10. Verify the frequency reading on the Universal Counter is 2.048 MHz \pm 6Hz. This is now the output of the HP 3784A RX REF CLOCK.
11. Disconnect all test equipment

8.14 Transmitter PRBS Pattern Verification

DESCRIPTION

The HP 3784A offers the choice of seven internally generated PRBS patterns. This test verifies the length and the number of "1"s in each sequence. The Zero Substitution function, which allows part of each sequence to be replaced with zeros, is also checked.

SPECIFICATION

7 different lengths of PRBS pattern are offered:

- $2^6 - 1$
- $2^9 - 1$ to CCITT Rec V.52
- $2^{11} - 1$ to CCITT Rec O.152
- $2^{15} - 1$ to CCITT Rec O.151
- $2^{17} - 1$ French Industry Standard
- $2^{20} - 1$ (Not zero limited)
- $2^{23} - 1$ to CCITT Rec O.151

Zeros Substitution :- Up to 999 zeros may be substituted for the data in each PRBS pattern. Substitution starts at the beginning of the longest run of zeros in the pattern. If the bit following the substituted zeros is also a "0", it is set to a "1".

EQUIPMENT

Universal Counter HP 5335A

PROCEDURE

1. Select Page 1 Preset Panel on the HP 3784A and set the instrument to its Default Settings.
2. Select Page 2 Tx Setup and set to Data Out [BINARY][TTL].
3. Connect HP 3784A TX CLOCK OUT port to Universal Counter Input A (terminated in 75 Ohms) and the rear panel SELECTABLE port to Input B (terminated in 50 Ohms, AC coupled).
4. Set the HP 3784A Pattern to each of the PRBS patterns in Table 8-9 and verify the RATIO A/B readings are as shown in Table 8-9.

Table 8-9. PRBS Sequence Length Verification

Tx Setup Pattern [PRBS] []	Universal Counter RATIO A/B
2 ⁶ - 1 [6]	63
2 ⁹ - 1 [9]	511
2 ¹¹ - 1 [11]	2047
2 ¹⁵ - 1 [15]	32767
2 ¹⁷ - 1 [17]	131071
2 ²⁰ - 1 [20]	1048575
2 ²³ - 1 [23]	8388607

- Connect the HP 3784A 75 ohm TX DATA OUT port to Universal Counter Channel A.
- Again set the HP 3784A Pattern to each of the PRBS Patterns and verify the reading on the Universal Counter for RATIO A/B is as shown in Table 8-10.

Table 8-10. Transmitter PRBS Pattern Verification

PRBS	Tx Data Out RATIO A/B
2 ⁶ - 1	16
2 ⁹ - 1	128
2 ¹¹ - 1	512
2 ¹⁵ - 1	8192
2 ¹⁷ - 1	32768
2 ²⁰ - 1	262144
2 ²³ - 1	2097152

Zero Substitution

- On Page 2 Tx Setup set Pattern to [PRBS]-[6], set the Zerosub field to each of the values shown in Table 8-11 and verify the Universal Counter reading for RATIO A/B.

Table 8-11. Zerosubstitution

Substituted Zeros Zero Sub []	Universal Counter Reading
000	16
001	17
009	15
029	10
039	7
049	4
059	1

- Disconnect all test equipment.

8.15 Transmitter Alternating Word

DESCRIPTION

This test verifies the Transmitter Alternating Word function. Two 8-bit words are programmed and alternated by a signal applied to the EXT MOD/ALT WORD port from an external source. As WORDS A and B are alternated, the output at TX DATA OUT will be a signal equal to the alternating frequency.

Option 002 also allows you to use an internal source to alternate the two words.

SPECIFICATION

Alternating Word Port

Impedance50 ohms nominal to ground
ThresholdNominal to Ground
Frequency Range dc to 100 kHz for square waves

TEST EQUIPMENT

Programmable Signal SourceHP 8165A
Universal CounterHP 5335A

PROCEDURE

1. Connect the equipment as shown in Figure 8-7.

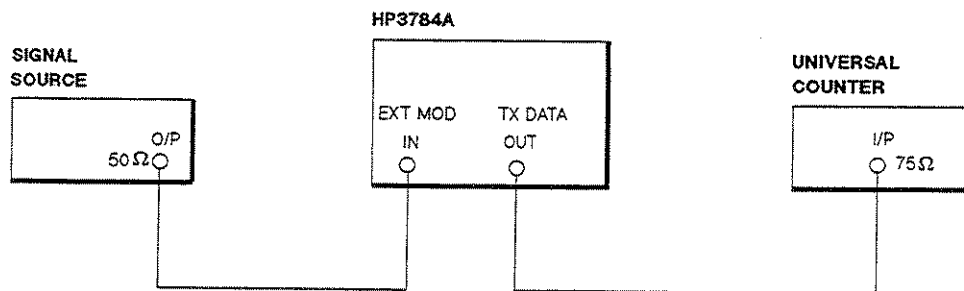

Figure 8-7 Alternating Word Test Set-up

2. Select Page 1 Preset Panel on the HP3784A and set the instrument to its Default Settings.

3. Select Page 2 Tx Setup and set as follows:

2 Tx Setup:	Data Out [BINARY] [TTL]
Clock [STD RATE] [34 MHz]	Offset [+0] ppm
Pattern [ALT WORD]	WORD [A] [11111111]
Er Add (bit) [OFF]	Clock Out [NORM]

4. Now select word [B] and set to [00000000].
5. Set the Signal Source to a 1 V p-p square wave and set the frequency to each of the values shown in Table 8-12. Verify the frequency reading on the Universal Counter is equal to the selected frequency. Channel A trigger on the Counter may require adjustment.

Table 8-12. Alternating Word Verification

Frequency (Hz)	Universal Counter Reading (Hz)
2	2
10	10
100	100
200	200
1000	1000
10 000	10000
100 000	100000 ±1
200 000	200000 ±2

6. Now set the Signal Source amplitude to 600 mV p-p at a frequency of 1 kHz. Verify the TX DATA OUT frequency on the Universal Counter is 1.000kHz.
7. Increase the Signal Source output level to 3 V p-p at 1 kHz. Again verify the Universal Counter reading is 1.000kHz.
8. Disconnect all test equipment

8.16 Ternary Data Outputs

DESCRIPTION

This test verifies the format and coding of the transmitter ternary data output. The pulse shape is verified at all the clock rates and the AMI/HDB3 coding is checked.

SPECIFICATION

Data rates.....	704, 2048, 8448 and 34368 kb/s
Format	RZ
Line Code.....	AMI or HDB3
Amplitude (704, 2048, 8448kb/s unbalanced)	2.37V peak
Amplitude (704, 2048kb/s balanced).....	3.0V peak $\pm 10\%$
Amplitude (34368kb/s unbalanced).....	1.0V peak $\pm 10\%$
Amplitude Ratio +ve/-ve	1:1 ± 0.05
Transition Times(20% - 80%) unbalanced.....	<5ns
Transition Times(20% - 80%) balanced.....	<10ns
Overshoot	<10%
Impedance	75 ohm nominal unbalanced to ground at all four rates 120 ohm nominal balanced at 704 and 2048kb/s

EQUIPMENT

Oscilloscope	See Table 8-1
120 ohm Balanced / 75 ohm Unbalanced Converter	HP 15508C

PROCEDURE

1. Connect the HP 3784A, 75 ohm, TX DATA OUT port to Channel A of the Oscilloscope (terminated in 75 Ohms).
2. Select Page 1 Preset Panel and set the instrument to its Default Settings.
3. Select Page 2 Tx Setup and set to the following:

2 Tx Setup:	Data Out [75 TERM] [AMI]
Clock [STD RATE] [34 MHz]	Offset [+0]ppm
Pattern [WORD] [4]Bit [1000]
Er Add [bit] [OFF]	Clock Out [NORM]

Pulse Shape (Unbalanced Output)

- Adjust the Oscilloscope to obtain an isolated positive pulse as shown in Figure 8-8.

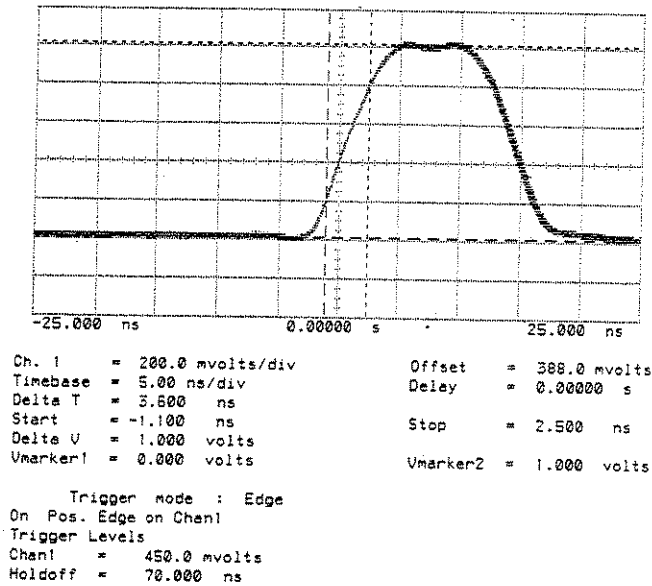

Figure 8-8 Isolated positive pulse at 34MHz

- Check the pulse has the following characteristics (refer to Figure 8-9 for details of pulse characteristics):
 Pulse Amplitude = $1.0V \pm 0.1V$
 Transition Time < 5ns
 Overshoot < 0.1V

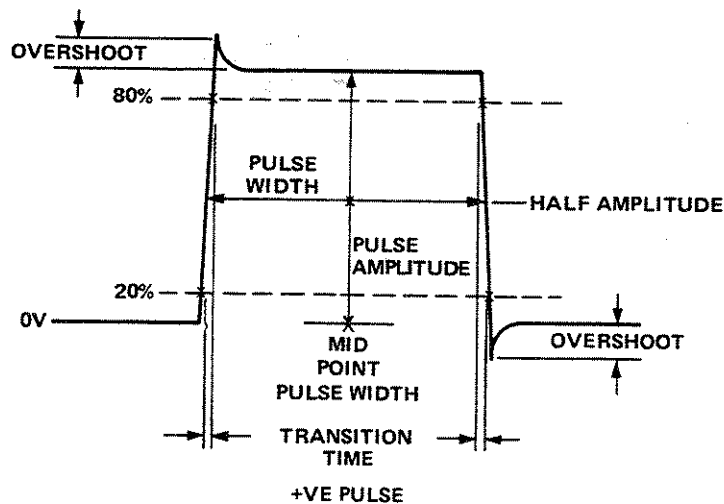

Figure 8-9 Pulse Characteristics

6. Adjust the Oscilloscope to obtain an isolated negative pulse and repeat step 5.
7. Adjust the Oscilloscope to view both the positive and negative pulses and verify the +ve to -ve pulse amplitude ratio is $1:1 \pm 0.05$
8. Set the HP 3784A Page 2 Tx Setup to Clock [STD RATE][8 MHz]
9. Repeat steps 4 to 7 for the following pulse characteristics:

Pulse Amplitude = $2.37V \pm 0.23V$
 Transition Time < 5ns
 Overshoot < 0.1V
 Amplitude Ratio 1:1 ± 0.05

10. Set the HP 3784A Page 2 Tx Setup to Clock [STD RATE][2 MHz]
11. Repeat steps 4 to 7 for the pulse characteristics given in step 9.
12. Set the HP 3784A Page 2 Tx Setup to Clock [STD RATE][704 KHz]
13. Repeat steps 4 to 7 for the pulse characteristics given in step 9.

Pulse Shape (Balanced Output)

14. Disconnect the 75 ohm Tx DATA OUT port from the Oscilloscope and connect the 120 ohm Tx DATA OUT port to the Oscilloscope via the 120 ohm Bal / 75 ohm Unbal Converter and a 120 ohm Balanced Cable.
15. Set the HP 3784A Page 2 Tx Setup to Data Out [120 TRM][AMI]
16. Repeat steps 4 to 7 for the following pulse characteristics:

Pulse Amplitude = $2.37 \pm 0.23V$
 Transition Time < 10ns
 Overshoot < 0.1V
 Amplitude Ratio 1:1 ± 0.05

17. Set the HP 3784A Page 2 Tx Setup to Clock [STD RATE][2 MHz]
18. Repeat steps 4 to 7 for the pulse characteristics given in step 16.

AMI/HDB3 Coding

19. Set the HP 3784A Page 2 Tx Setup to the following:

2 Tx Setup:	Data Out [120TRM][AMI]
Clock [STD RATE][2 MHz]	Offset [+0]ppm
Pattern [WORD][5]Bit [10000]
Er Add [OFF]	Clock Out [NORM]

20. Check that the displayed waveform is as shown in Figure 8-10

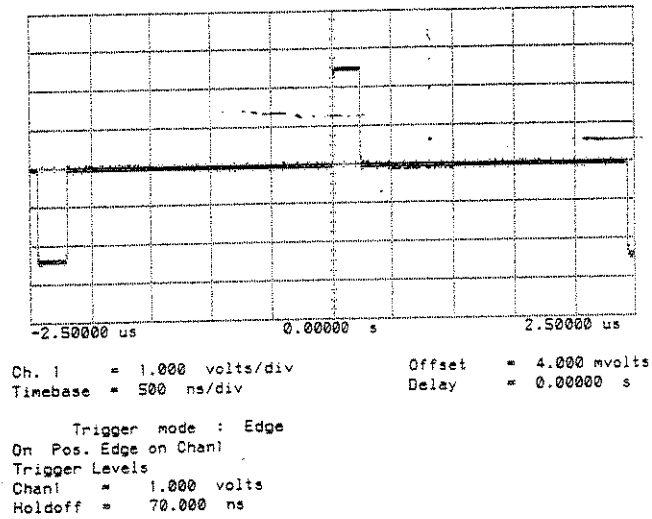

Figure 8-10 Tx DATA (10000 WORD AMI)

21. Set the HP 3784A Page 2 Tx Setup to Data Out [120 TRM][HDB3]
22. Check that the displayed waveform is as displayed in Figure 8-11

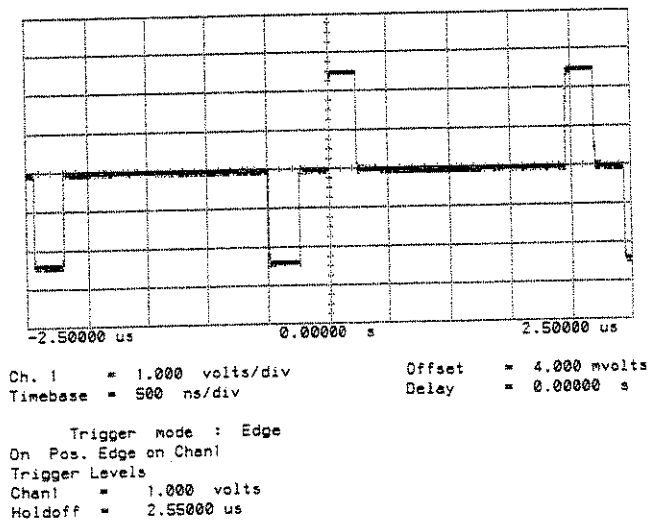

Figure 8-11 Tx DATA (10000 WORD HDB3)

23. Disconnect all test equipment.

8.17 Bit and Code Error Add

DESCRIPTION

This test verifies the HP 3784A Transmitter Error Add function. Bit or Code Errors can be added at a specified rate or singly using the Single Error Add key. When code errors are added to HDB3 ternary data, bit errors may also be introduced.

The Bit Error Add Facility which allows errors to be added at a continuous rate or singly using the ERROR ADD key, is checked using a Universal Counter. Errors are added to a "0000" WORD pattern and measured at the TX DATA OUT port.

Code Error Add is checked by injecting single errors to a ternary data stream and looking at the output on an Oscilloscope. The polarity of the signal changes each time an error is injected.

It is not necessary to check the code error add rates because the circuitry which injects the correct number of errors is the same as for the bit errors.

SPECIFICATION

Bit Error Add	"Zeros" are set to "ones" and vice versa.
Code Error Add	HDB3: Positive and negative "ones" are set to "zeros" and "zeros" are set to positive "ones". AMI: Positive "ones" are set to negative "ones" and vice versa.
Single	One error added for each press of the ERROR ADD key. The led is illuminated when this key is enabled.
Rate	Selectable from 1 in 10^3 , 10^4 , 10^5 or 10^6 .

EQUIPMENT

Universal Counter	HP 5335A
Oscilloscope	See Table 8-1

PROCEDURE

1. Connect the HP 3784A, 75 ohm, TX DATA OUT port to Channel A of the Universal Counter (terminated in 75 Ohms, AC coupled).
2. Select Page 1 Preset Panel on the HP 3784A and set the instrument to its Default Settings.

Bit Error Add

3. Select Page 2 Tx Setup and set as follows:

```

2 Tx Setup:      Data Out [BINARY][TTL ]
Clock [STD RATE][ 34MHz] Offset [ +0]ppm
Pattern [WORD][_4]Bit [0000      ]
Er Add (bit) [RATE]- [3] Clock Out [NORM]
```

4. For each Er Add(bit)[RATE] shown in Table 8-13, verify the frequency reading on the Universal Counter.

Table 8-13. Error Add Rate Check

Error Add (bit) [RATE] Page 2	Universal Counter Reading (Hz)
-[3]	34,368 E3
-[4]	3.4368 E3
-[5]	343.68
-[6]	34.368

5. To verify the Single or Manual Error Add, select Page 2 Tx Setup and set to Er Add(BIT)[MAN].
6. Set the Universal Counter to measure absolute count (TOT A function) and press Gate OPEN key.
7. Press the ERROR ADD key a few times and verify the count on the Universal Counter increments each time the key is pressed.

Code Error Add

8. On Page 2 Tx Setup, set to Data Out [75 TERM][AMI], Pattern[WORD][2][10] and Er Add[CODE][MAN].
9. Connect HP 3784A TX DATA OUT port to Channel A (terminated in 75 ohms) of the Oscilloscope and the rear panel SELECTABLE port to Channel B (terminated in 50 ohms). Set the Oscilloscope to trigger on Channel B.
10. Press the ERROR ADD key a few times and check that the polarity of the data waveform on Channel A of the Oscilloscope inverts each time.
11. Disconnect all test equipment.

8.18 Receiver Binary Data and Clock

DESCRIPTION

The Binary Data and Clock inputs are verified from minimum to maximum clock rates. The interface TTL/ECL select and Clock Inverse function are checked.

SPECIFICATION

Format Clock and NRZ Data
Frequency Range 1kHz to 50MHz
Level - Clock Input TTL/ECL linked to Data Selection.
- Data Input User Selectable TTL/ECL linked to Transmitter
Phasing User selectable Normal or Inverted polarity

EQUIPMENT

Frequency Synthesizer HP 3335A

PROCEDURE

1. Connect the Frequency Synthesizer 75 ohm output to the HP 3784A TX CLOCK IN port.

NOTE: Option 002 Instruments. Select Page 12 Self Test: and set to Function [TYPE & REVISION] Instrument Type 3784A [Standard]

2. Select HP 3784A Page 1 Preset Panel and set the instrument to its Default Settings.
3. Connect TX DATA OUT port to RX BIN DATA IN port and TX CLOCK OUT port to RX CLOCK IN port.
4. Select Page 2 Tx Setup and set to the following:

2 Tx Setup.	Data Out [BINARY] [TTL]
Clock [EXT]Hz	Offset [+0]ppm
Pattern [PRBS]- [23]	Zero Sub [000]
Er Add (bit) [OFF]	Clock Out [NORM]

- Set the Frequency Synthesizer amplitude to +5dB and the frequency to the values in Table 8-14. Verify for each setting that the HP 3784A RX CLOCK IN led is on and that the BIT and CODE ERRORS and SYNC LOSS ALARM leds remain extinguished.

Table 8-14. Received Clock Check

Frequency Synthesizer Setting	HP 3784A Page 4 [ERROR RESULTS] Rx Frequency ...Hz
1.0kHz	1000
10.0kHz	10000
100.0kHz	100 000 ±1
1.0MHz	1000 000 ±3
10.0MHz	10000 000 ±30
50.0MHz	50000 000 ±150

- Set Page 2 Tx Setup to Data Out [BINARY][ECL] and to Clock Out [INV]. Check that at the 50MHz Frequency Synthesizer setting, the HP3784A BIT ERRORS, CODE ERRORS and SYNC LOSS ALARM leds remain extinguished.
- Select Page 3 Rx Setup and set to Clock [INV]. Check that the HP3784A BIT ERRORS, CODE ERRORS and SYNC LOSS ALARM leds are still extinguished.
- Disconnect all test equipment.

8.19 Receiver Clock Recovery

DESCRIPTION

The clock for the coded ternary data is recovered from the incoming data at the RX DATA IN port. This test verifies the capture range of the clock recovery circuitry at each of the standard bit rates and with 24 zeros substituted into the AMI data. The receiver clock output is monitored.

SPECIFICATION

Bit Rates: Dedicated clock recovery constrains to one of four fixed frequencies and is specified for the following codes:
704 kHz AMI with up to 24 zeros together or HDB3.
2048 kHz AMI with up to 24 zeros together or HDB3.
8448 kHz HDB3
34368 kHz HDB3

Rate Tolerance: ± 120 ppm.
Format: RZ AMI or HDB3 code.
Pulse Width: $(50 \pm 6)\%$ of bit period.

EQUIPMENT

Frequency Synthesizer HP 3335A
Universal Counter HP 5335A

PROCEDURE

1. Connect the equipment as shown in Figure 8-12.

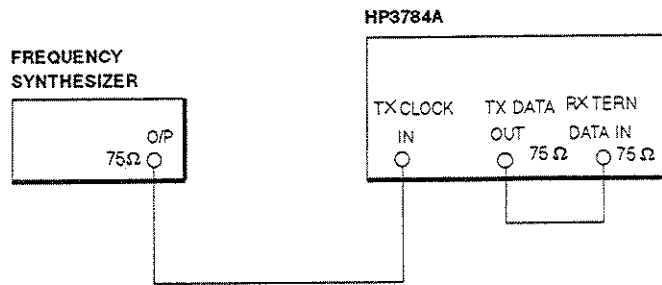

Figure 8-12 Receiver Clock Recovery Test Set-up

2. Select HP 3784A Page 1 Preset Panel and set the instrument to its Default Settings.
3. Select Page 2 Tx Setup and set to Clock[EXT] and Pattern[PRBS][6].

- Select Page 3 Rx Setup and set to the following:

3 Rx Setup [MAN] Data In [75TERM][HDB3] Clock Rate [704kHz] Pattern [AS TX]

- Set the Synthesizer output level to + 5 dBm. Set the frequency and Page 3 Clock Rate values as shown in Table 8-15. Verify for each setting that the HP 3784A BIT ERRORS and SYNC LOSS leds remain extinguished.

Table 8-15. Clock Recovery at Standard Rates

Frequency Synthesizer Setting (Hz)	HP 3784A Page 3 Clock Rate []
703 915 704 085	[704kHz]
2047 754 2048 246	[2MHz]
8446 986 8449 014	[8MHz]
34 363 876 34 372 124	[34MHz]

- Now select Page 2 Tx Setup and set to Data Out [75 TERM][AMI] and Zerosub[024].
- Set the Synthesizer frequency to each value in Table 8-16 and verify that for each setting that the HP 3784A BIT ERRORS and SYNC LOSS ALARM leds remain extinguished.

Table 8-16. AMI Data with 24 Zeros Substituted

Frequency Synthesizer (MHz)	HP 3784A Page 3 Rx Setup
0.704 2.048	[704KHz] [2MHz]

- Disconnect all test equipment.

8.20 Ternary Data Input Levels

DESCRIPTION

Automatic equalization is provided at the receiver ternary data input ports. The equalization is checked by inserting a length of attenuating cable between the Transmitter and Receiver and verifying that the signal can be detected. For each ternary data input level a "MON" mode is available which provides additional gain for operation at protected monitor points. This test checks that the additional gain can be provided.

SPECIFICATION

Format AMI or HDB3 code, RZ
 Pulse Width (50 ±6) % of bit period.
 Amplitude Automatic root f equalization as per CCITT Rec 703 paras 6, 7 and 8

Table 8-17. Root f Equalisation

Nominal Bit Rate (kbit/s)	704	2048	8448	34368
Nominal max peak voltage (75 Ω)	2.37	2.37	2.37	1.00
Nominal max peak voltage (120 Ω)	3.00	3.00	-	-
Max loss at 1/2 bit rate (dB)	3	6	6	12

Table 8-18. Monitor Mode Additional Gain

Nominal Bit Rate (kbit/s)	704	2048	8448	34368
Additional Gain Provided (dB)	30	30	30	26

EQUIPMENT

Attenuator HP 3750A
 Cable 480ft (146.3m) Belden cable

PROCEDURE

1. Connect the equipment as shown in Figure 8-13 below.

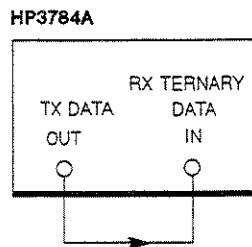

Figure 8-13 Ternary Data Input Test Set-up

2. Select Page 1 Preset Panel on the HP 3784A and set instrument to its Default Settings.

3. Select Page 5 Gating Period and set to Gating Type [SINGLE] Period [0]d [0]h [0]m [5]s. Select Page 4 [ERROR RESULTS] and set to Rx [CODE ERR][COUNT].
4. Press the MEASURE START/STOP key to start the measurement gating and at the end of the 5 second gating period, check the Rx Bit and Code Error count is zero.
5. Select Page 2 Tx Setup and repeat step 4 at [STD RATE], [8MHz], [2MHz], and [704kHz]. Ensure each clock rate is error free.
6. Now connect the Attenuator between the Belden cable and the HP 3784A RX TERNARY DATA IN port.
7. Select Page 3 Rx Setup and set to the following:

```
3 Rx Setup [MAN] Data In [75 MON] [AMI]
                                Clock Rate [704kHz]
Pattern [AS TX]
```

8. Set the Attenuator to 30dB and check all the front panel ALARMS are extinguished.
9. Select Page 4 [ERROR RESULTS] and press the MEASURE START/STOP key. At the end of the gating period, check on Page 4 that the Rx Bit and Code Error Count is zero.
10. Repeat step 9 for a clock rate of [2MHz]. Be sure to change the clock rate on both the Tx and Rx Pages.
11. Disconnect all test equipment.

8.21 Reference WORD and Synchronization

DESCRIPTION

The HP 3784A Receiver n-Bit WORD reference pattern generation Sync Loss and Sync Gain criteria are checked using an output data pattern from the Transmitter.

A binary WORD pattern from the Transmitter is input to the RX BIN DATA IN port. One bit of the Receiver reference pattern is changed to force loss of synchronization. It is then reset to ensure synchronization is regained and the SYNC LOSS led goes out.

SPECIFICATION

Reference n-Bit WORD patterns	n-Bit programmable WORD pattern. n selectable between 1 and 16.
Sync Loss	> or = 1 error in 9 bits over last 100ms.
Sync Gain	≤ 1 error in 100 bits.

Procedure

1. Connect HP3784A, 75 ohm, TX DATA OUT port to RX BIN DATA IN port and TX CLOCK OUT port to RX CLOCK IN port.
2. Select Page 1 Preset Panel on the HP 3784A and set the instrument to its Default Settings.
3. Select Page 2 Tx Setup and set to the following :

```
2 Tx Setup:      Data Out [BINARY][TTL ]
Clock [STD RATE][34 MHz] Offset [ +0]ppm
Pattern [WORD][16]Bit [10101010101010]
Er Add (bit) [OFF ]      Clock Out [NORM]
```

4. Select Page 3 Rx Setup and set to the following :

```
3 Rx Setup [MAN] Data In [BINARY][TTL]
Clock [NORM]      Clock Rate [34 MHz]
Pattern [WORD][16]Bit [10101010101010]
Jitter Display Rate [FAST]
```

5. Verify the Rx CLOCK IN led is on.
6. Verify all front panel ALARM leds are off.
7. Now on both Page 2 Tx Setup and Page 3 Rx Setup, change the pattern [WORD] to [01010101010101]

8. Verify all front panel ALARM leds are still off.
9. Now change the Page 3 Rx Setup Pattern [WORD] to [1101010101010101].
Verify the front panel SYNC LOSS ALARM led remains extinguished.
10. Now change the Page 3 Rx Setup [WORD] to [1111010101010101]
Verify the SYNC LOSS ALARM led is illuminated.
11. Now change the word back to the setting used in step 9.
Verify the SYNC LOSS ALARM led is once again extinguished.
12. Disconnect all test equipment.

8.22 Receiver Reference PRBS Patterns and Zero Substitution

DESCRIPTION

This test uses the HP 3784A Transmitter to verify the seven reference PRBS patterns at the Receiver and to check the zero substitution function.

SPECIFICATION

PRBS Patterns	As Transmitter
Zero substitution	As Transmitter

EQUIPMENT

This test uses the HP 3784A Transmitter to verify the Receiver operation.

PROCEDURE

Reference PRBS Generation

1. Connect the HP 3784A, 75 ohm, TX DATA OUT port to the , 75 ohm, RX BIN DATA IN port and the TX CLOCK OUT port to the RX CLOCK IN port.
2. Select Page 1 Preset Panel on the HP 3784A and set the the instrument to its Default Settings.

3. Select Page 2 Tx Setup and set to the following:

```
2 Tx Setup:      Data Out [BINARY][TTL ]
Clock [STD RATE][34 MHz] Offset [ +0]ppm
Pattern [PRBS]-[6]      Zero Sub[000]
Er Add (bit) [OFF ]    Clock Out [NORM]
```

4. Select Page 3 Rx Setup and set to the following:

```
3 Rx Setup [MAN] Data In [BINARY][TTL]
Clock [NORM]      Clock Rate [34 MHz]
Pattern [PRBS]-[6]      Zero Sub [000]
Jitter Display Rate [FAST]
```

5. Verify that the front panel ALARM leds are extinguished.
6. Repeat steps 3, 4 and 5 with Pattern [PRBS] settings of 9, 11, 15, 17, 20 and 23.

Zero Substitution

7. Select Page 2 Tx Setup and set to the following:

```
2 Tx Setup:      Data Out [BINARY][TTL ]
Clock [STD RATE][34 MHz] Offset [ +0]ppm
Pattern [PRBS]-[6]      Zero Sub[032]
Er Add (bit) [OFF ]    Clock Out [NORM]
```

8. Select Page 3 Rx Setup and set to the following:

```
3 Rx Setup [MAN] Data In [BINARY][TTL]
Clock [NORM]      Clock Rate [34 MHz]
Pattern [PRBS][6]      Zero Sub [032]
Jitter Display Rate [FAST]
```

9. Verify that all the HP 3784A front panel ALARM leds are extinguished.

10. Repeat steps 7, 8 and 9 for the Zero Sub [] and Pattern [PRBS][] values shown in Table 8-19.

Table 8-19. Zero Substitution Check

Pattern [PRBS] []	Zerosub []
- [9]	[6]
- [11]	[20]
- [15]	[100]
- [17]	[300]
- [20]	[555]
- [23]	[999]

11. Disconnect all test Equipment

8.23 Receiver Autoconfigure and AIS Indication

DESCRIPTION

The HP 3784A has the facility to automatically configure the receiver to the input clock and data signals. This test uses the transmitter to input different clock and data signals to the receiver to verify the function is operating correctly.

SPECIFICATION

Clock (for Binary operation) 704kHz 2048kHz 8448kHz 34.368MHz

Data, Binary and Ternary

Pattern As Transmitter

Note: Although the Zero Sub field is displayed on Page 3 Rx Setup this is not configured automatically.

TEST EQUIPMENT

This test uses only the HP 3784A Transmitter to verify the receiver.

PROCEDURE

Coded Ternary Data Input

1. Select Page 1 Preset Panel on the HP 3784A and set the instrument to its Default Settings.
2. Connect the HP 3784A, 75 ohm, TX DATA OUT port to the 75 ohm RX TERNARY DATA IN port.
3. Select Page 3 Rx Setup and set as follows:

```
3 Rx Setup [AUTO]
Connect test signal(s)...
Then press EXEC. key to start autosetup.
```

4. Press the **EXEC** key and verify the receiver parameters are set and displayed as follows.

```
3 Rx Setup [MAN] Data In [75TERM][HDB3]
Clock Rate [34 MHz]
Pattern [PRBS]-[23] Zero Sub [000]
```

- Now set Page 2 Tx Setup Page to each of the following configurations and verify the corresponding setup has been achieved on Page 3 Rx Setup (as in steps 3 and 4).
Note: Allow a few seconds each time for the Auto setup function to be completed.

Tx Setup 1

```

2 Tx Setup:      Data Out [75TERM] [HDB3]
Clock [STD RATE][ 8 MHz] Offset [ +0]ppm
Pattern [WORD][ 1]Bit [0          ]
Er Add (bit)[OFF]      Clock Out [NORM]
  
```

After Rx Setup [AUTO]

```

3 Rx Setup [MAN]  Data In [75TERM] [HDB3]
                                   Clock Rate [ 8 MHz]
Pattern [WORD][ 1]Bit [0          ]
  
```

- Connect the 75 ohm TX DATA OUT to the 75 ohm RX BIN DATA IN and TX CLOCK OUT to RX CLOCK IN.

Tx Setup 2

```

2 Tx Setup:      Data Out [BINARY] [TTL ]
Clock [STD RATE][ 2 MHz] Offset [ +0]ppm
Pattern [PRBS]-[ 6]      Zero Sub [000]
Er Add (bit)[OFF]      Clock Out [NORM]
  
```

After Rx Setup [AUTO]

```

3 Rx Setup [MAN]  Data In [BINARY] [TTL ]
Clock [NORM]
Pattern [PRBS]-[ 6]      Zero Sub [000]
  
```

AIS Detection

- Disconnect the front panel cables and connect the TX DATA OUT port to the RX TERNARY DATA IN port.
- Select the HP 3784A Page 1 Preset Panel and set the instrument to its Default Settings
- On Page 2 Tx Setup select Pattern [WORD][1]Bit [1].
- Verify that the front panel AIS ALARM led is illuminated.
- Select Pattern [WORD][2]Bit [10] and verify the AIS ALARM is now extinguished.
- Disconnect all test equipment

8.24 Measurement Gating and Power Loss Alarm

DESCRIPTION

The Measurement Gating is verified by inputting errors at a fixed rate to the HP 3784A Receiver.

SPECIFICATION

MANUAL	Controlled by MEASURE START/STOP key.
Timed SINGLE	Initiated by means of MEASURE START/STOP key and terminated at end of selectable measurement interval.
Timed REPETITIVE	Initiated by means of MEASURE START/STOP key. At the end of each gating period, a new one is started until the measurement is terminated using the MEASURE START/STOP key.

EQUIPMENT

The HP 3784A Transmitter is used to verify the receiver.

PROCEDURE

1. Connect TX DATA OUT port to RX TERNARY DATA IN port.
2. Select Page 1 Preset Panel on the HP3784A and set the instrument to its Default Settings.
3. Select Page 2 Tx Setup and set to Er. Add[BIT][RATE]-[3].
4. Select Page 4 [ERROR RESULTS] and press MEASURE **START/STOP** key. Verify the led above the key illuminates.
5. Check the Rx Bit Error [RATIO] result on Page 4 [ERROR RESULTS] is 1.000E-03.
Press the MEASURE **START/STOP** and verify the led extinguishes.
6. Select Page 5 Gating Period and set as follows:

```
5 Gating Period.  
Gating type [SINGLE]  
Period [ 0]d [ 0]h [ 0]m [ 1]s  
Errored/Error free intervals [SECONDS]
```

7. Select Page 4 [ERROR RESULTS] and press MEASURE **START/STOP** key.
8. At the end of the gating period, verify the ERROR COUNT result is between 34367 and 34369.

8.25 Error Out

DESCRIPTION

This test verifies the Receiver BIT and CODE Error Out as selected on Page 10 Rear Panel Ports

SPECIFICATION

Pulse Width Nominal one clock period
Impedance Nominal low unbalanced to GND
Amplitude Nominal ECL levels
External Load..... 50 ohms to -2V, DC coupled
50 ohms to ground, AC coupled

One pulse per BIT or CODE Error detected by the HP 3784A Receiver.

EQUIPMENT

Universal CounterHP 5335A
OscilloscopeSee Table 8-1

PROCEDURE

1. Select Page 1 Preset Panel on the HP 3784A and set the instrument to its Default Settings.
2. Connect the HP 3784A, 75 ohm, TX DATA OUT port to the 75 ohm RX TERNARY DATA IN port.
3. Select Page 2 Tx Setup and set to Pattern [WORD][4] Bit [1000] and Er Add [BIT][RATE]-[3].
4. Connect Rear Panel RX ERROR OUT port to Universal Counter (terminated in 50 Ohms, AC coupled) and verify it displays a reading of 34.368 kHz.

Verify the HP 3784A front panel BIT ERRORS ALARM led is on.

5. Select Page 10 Rear Panel Ports and set to Error Out[CODE] and verify that no transitions are detected by the counter.
6. Select Page 2 Tx Setup and set to Er Add[CODE][RATE]-[3].

Verify the Universal Counter reading is now 34.368 kHz.

7. Connect the ERROR OUT port to channel A of the Oscilloscope, 50 ohm termination.

Verify the display is as shown below:

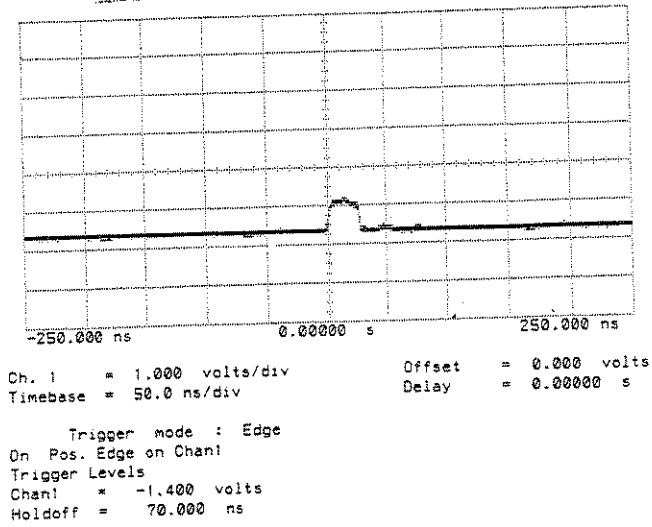

Figure 8-14 Error Out Port.

8. Disconnect all test equipment

8.26 Receiver Error Detection and Measurement

DESCRIPTION

The HP 3784A Transmitter is used to check that the Receiver is detecting and measuring errors correctly.

Bit Error Detection is verified by setting the Transmitter and Receiver to different n-Bit WORD patterns and verifying the Receiver Bit Error Ratio result.

AMI and HDB3 Code Error Detection are verified by inserting errors at the Transmitter and verifying the Receiver Code Error Ratio.

The Receiver Error Out signal from the rear panel port is also verified. This signal can be selected as either the BIT or CODE Error Output by setting the appropriate field on Page 10 Rear Panel Ports.

SPECIFICATION

At TERNARY interfaces, bit and code errors can be measured simultaneously.

At BINARY interfaces, only bit errors are measured.

EQUIPMENT

The HP 3784A Transmitter is used to check the Receiver.

PROCEDURE

Bit Error Detection

1. Connect the HP 3784A , 75 ohm, TX DATA OUT port to the 75 ohm RX BIN DATA IN port and TX CLOCK OUT port to RX CLOCK IN port.
2. Select Page 1 Preset Panel on the HP 3784A and set the instrument to its Default Settings.
3. Select Page 2 Tx Setup and set to Data BINARY][TTL] and Word[16]Bit[111101010101010101010].
4. Select Page 3 Rx Setup and set to Word [16] Bit [1010101010101010].
5. Select Page 5 Gating Period and set to Gating Type [SINGLE] Period [0]d [0]h [0]m [5]s.
6. Select Page 4 [ERROR RESULTS] and press the MEASURE START/STOP key.

On completion of the 5 second gating period, verify the Rx Bit Error[RATIO] result is 6.25E-2.

AMI Code Error Detection

7. Connect TX DATA OUT port to Rx TERNARY DATA IN port.
8. Select Page 2 Tx Setup and set as follows:

```
2 Tx Setup:      Data Out [75TERM][AMI ]
Clock [STD RATE][ 2 MHz] Offset [ +0]ppm
Pattern [WORD][ 4]Bit [1000      ]
Er Add [CODE][RATE]-[3] Clock Out [NORM]
```

9. Select Page 3 Rx Setup and set to [AS TX].
10. Select Page 4 [ERROR RESULTS] and press the MEASURE **START/STOP** key.

On completion of the 5 second gating period, verify the CODE ERRORS led is illuminated and the Rx[CODE ERR][RATIO] is 1.000E-3.

11. Select Page 2 Tx Setup and set to Data Out [75 TERM][HDB3]
12. Select Page 4 [ERROR RESULTS] and press the **START/STOP** key.

On completion of the 5 second gating period, verify the CODE ERRORS led is illuminated and the Rx [CODE ERR][RATIO] is 1.000E-3.

13. Disconnect all cabling.

8.27 HP-IB Verification

DESCRIPTION

The following program will provide verification of the HP 3784A HP-IB Interface. The program assumes that the HP-IB is present at interface select code 7 (the default address is 705). If the HP-IB interface is located at another select code then alter the value in lines 150, 160 and 180.

SPECIFICATION

See Section 6 for full specification

TEST EQUIPMENT

Computer.....HP Series 200/300

PROCEDURE

1. Enter and run the following program to verify that data can be transferred to and from the HP 3784A.

```
10      !      3784A      HP-IB VERIFICATION PROGRAM
20      PRINT CHR$(12)
30      PRINT TAB(25);"3784A HP-IB VERIFICATION"
40      PRINT
50      PRINT
60      CALL Hp_ib_add(Address)      ! find instrument Hp-ib select address
70      CALL Read_reg(Address)      ! read 3784A Alarm Register
80      LOCAL Address
90      BEEP 400,.5
100     PRINT
110     PRINT "Program complete"
120     END
130     SUB Hp_ib_add(Address)
140         PRINT "Searching for 3784A Address"
150         ON TIMEOUT 7,1 GOTO Next_address
160         FOR Address=701 TO 731
170             DISP Address
180                 IF Address=721 THEN GOTO Next_address
190                 Inst_at=SPOLL(Address)
200                 IF Inst_at>0 THEN GOTO Found
210 Next_address:      !
220             NEXT Address
230             OFF TIMEOUT
240             IF Address>730 THEN Not_found
250 Found:      !
260             PRINT "3784A found at address";Address
270             GOTO Quit
280 Not_found:      !
290             PRINT "NO 3784A FOUND, CHECK CONNECTIONS & RERUN PROGRAM"
300             STOP
310 Quit:      !
320     SUBEND
330     SUB Read_reg(Address)
340         PRINT
350         OUTPUT Address;"ID?"
360         ENTER Address;Name$
370         IF Name$<>"HP3784A" THEN PRINT "HP-IB data transfer failed"
380     SUBEXIT
390     SUBEND
```

8.28 External Modulation Input (Option 002)

DESCRIPTION

The external jitter modulation capability is checked over the specified frequency range by measuring the jitter on both the Transmitter Clock and Data Outputs. The jitter is measured on an oscilloscope triggered from the HP 3784A TX REF CLOCK OUT port.

SPECIFICATION

Frequency RangeMeets CCITT Rec O.171 Table 2 for sinusoidal Modulation, and typically d.c. to 5% of the bit rate (2.5% at 34MHz)
ImpedanceNominal 50 ohms unbalanced to GND
SensitivityNominal 10UI/V (p-p figures at 5Hz)
Maximum Input Voltage 1.5V p-p
Maximum Jitter Amplitude 10.10UI p-p (As indicated on Tx Jitter Amplitude display)

TEST EQUIPMENT

OscilloscopeSee Table 8-1
Signal Source HP 8165A
Pulse Shape NetworkSee Figure 8-15
Power Supply HP 6284A
Universal Counter HP 5335A
Voltmeter HP 3478A
Blocking Capacitor HP 10240B

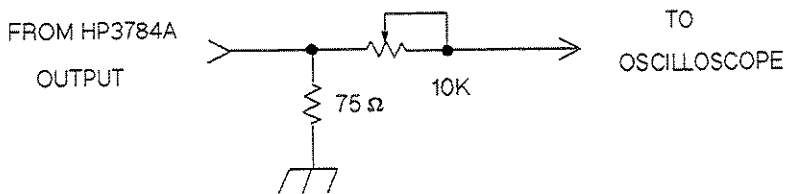

Figure 8-15 Pulse Shape Network

PROCEDURE

1. Select Page 1 Preset Panel on the HP 3784A and set the instrument to its Default Settings.

2. Connect the test equipment as shown in Figure 8-16.

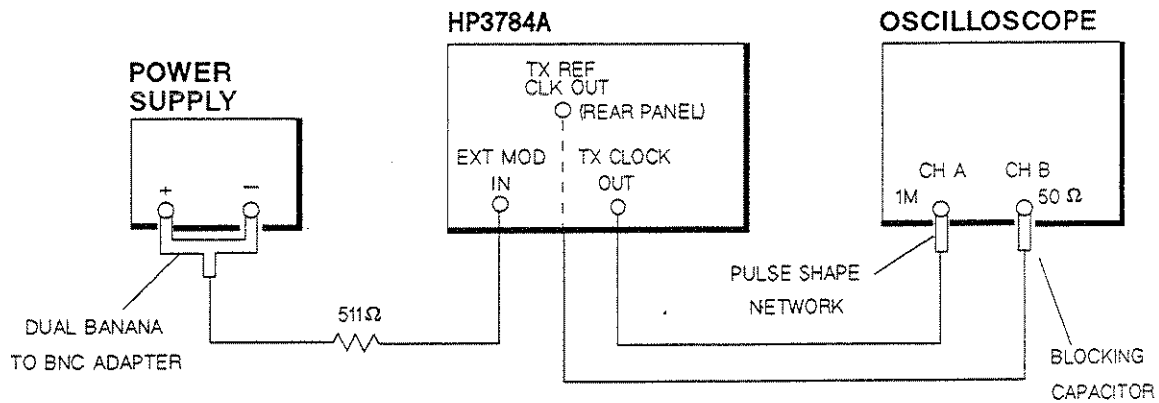

Figure 8-16 External Modulation Test Set-up 1 (Clock Output)

3. Select Page 2 TX Setup. Set the [STD RATE] to [2 MHz]
4. Select Page 4 [JITTER TRANSFER FN] and set to Modulation [EXTERNAL].
5. Slowly increase the Power Supply output voltage from 0V. The waveform on the oscilloscope display will be displaced as the voltage is increased. Check that the Channel A waveform can be displaced with respect to Channel B by at least 5.05 cycles as shown in Figure 8-17. (adjust the Pulse Shape Network to obtain the desired waveshape on Channel A).

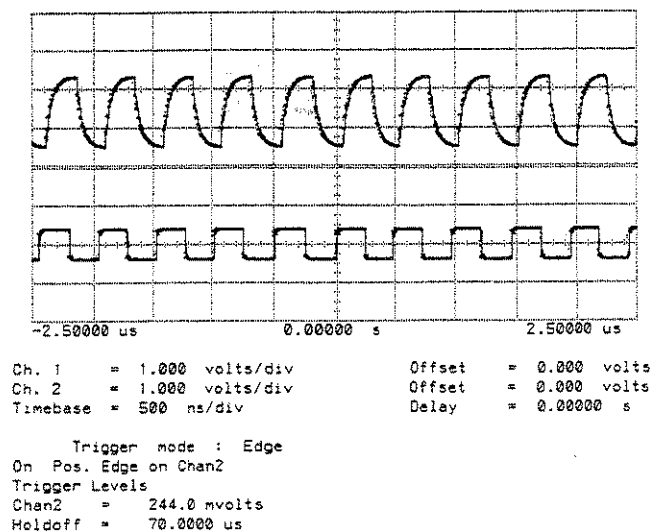

Figure 8-17 Pulse Shape Network Adjustment (10 Cycles Clock Output)

6. Reset the power supply to 0V and change over the Power Supply to give a negative output voltage.
7. Repeat step 5.
8. Select HP 3784A Page 2 Tx Setup and set to Data [STD RATE][8 MHz]
9. Repeat steps 5-7.
10. Select HP 3784A Page 2 Tx Setup and set to Data [STD RATE][34 MHz]
11. Repeat steps 5-7.
12. Now connect the equipment as shown in Figure 8-18.

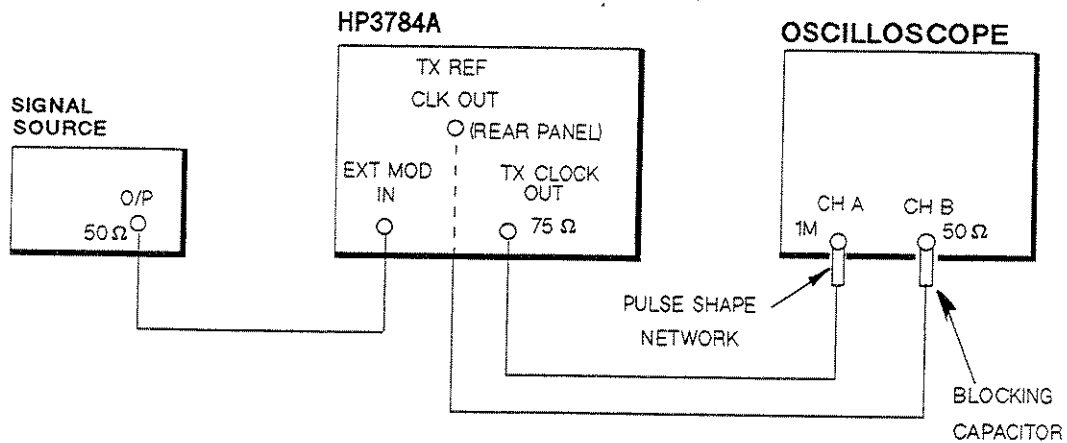

Figure 8-18 External Modulation Test Set-up 2 (Clock Output)

13. Select Page 2 Tx Setup and set to Clock [STD RATE][2 MHz] and Pattern [WORD][1][1]
14. Set the Signal Source output to a 100 kHz Sine Wave at 0 Volts.
15. Adjust the Oscilloscope timebase to calibrate 10 cycles of the Channel B waveform on the display. Adjust the Pulse Shape Network for a waveform as previously shown in Figure 8-17.

16. Increase the Signal Source output level until the jitter on the Channel A waveform is at least one division wide (0.5 UI p-p) as shown in Figure 8-19. Ensure that the Signal Source waveform amplitude does not exceed 1.5V p-p.

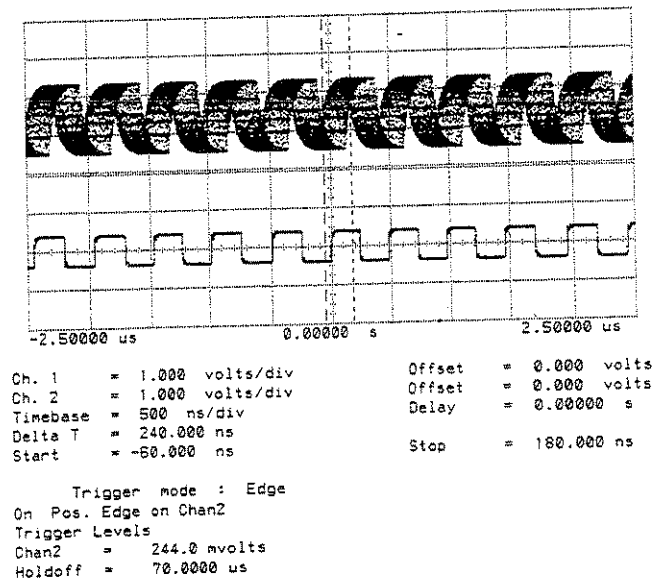

Figure 8-19 0.5UI p-p Jitter

17. Now set the HP 3784A to Data [STD RATE][8MHz] on Page 2 Tx Setup.
18. Set the Signal Source frequency to 400 kHz at 0 V and repeat steps 15 and 16.
19. Set the HP 3784A Page 2 Tx Setup to Data [STD RATE][34MHz]. Set the Function Generator frequency to 800 kHz at 0 V and repeat steps 14 and 15.
20. Select HP 3784A Page 2 Tx Setup and set to Data [STD RATE][2 MHz].

21. Connect test equipment as shown in Figure 8-20.

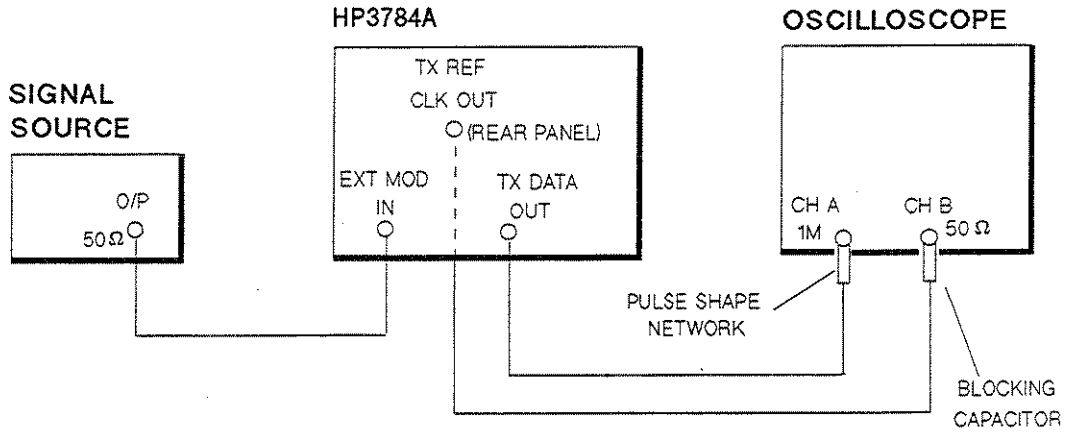

Figure 8-20 External Modulation Test Set-up (Data Output)

22. Select Page 2 Tx Setup and set to Pattern [WORD][4][1000]
23. Set the Signal Source frequency to 500 Hz and the output level to 0 Volts. Adjust the oscilloscope timebase for 10 cycles of the Channel B waveform. You may have to adjust the the Trigger Hold-Off to obtain correct triggering of the TX DATA OUTPUT.
24. Adjust the Pulse Shape Network for a waveform on Channel A similar to that as shown in Figure 8-21.

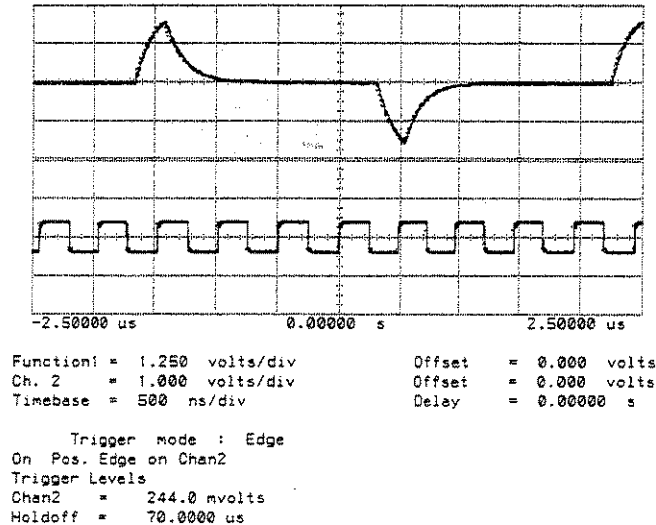

Figure 8-21 Pulse Shape Network Adjustment (Data Output)

25. Increase the Signal Source output from 0 Volts until the jitter on the TX DATA OUT waveform is 8 UI p-p i.e. when the pattern is seen to overlap as in Figure 8-22

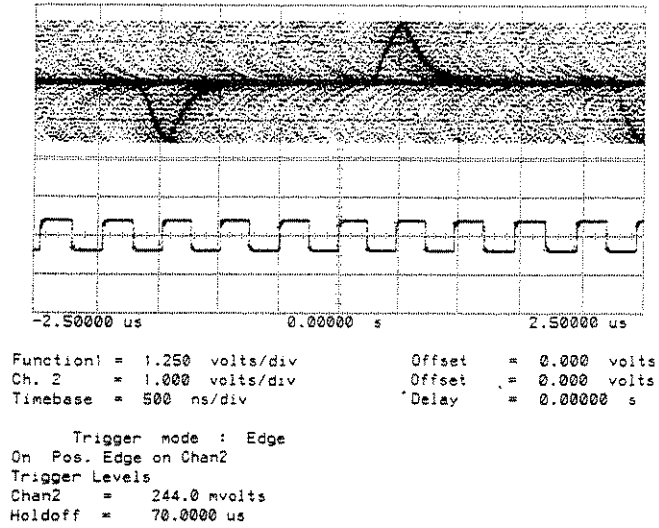

Figure 8-22 8UI p-p Jitter

26. Continue increasing the Signal Source output level until the jitter is seen to increase beyond the overlap point as shown in Figure 8-23 below. This is equivalent to 10 UI p-p jitter on the TX DATA OUTPUT. (Disregard the reading on HP 3784A Page 4 [JITTER TRANSFER] for Tx Jitter.

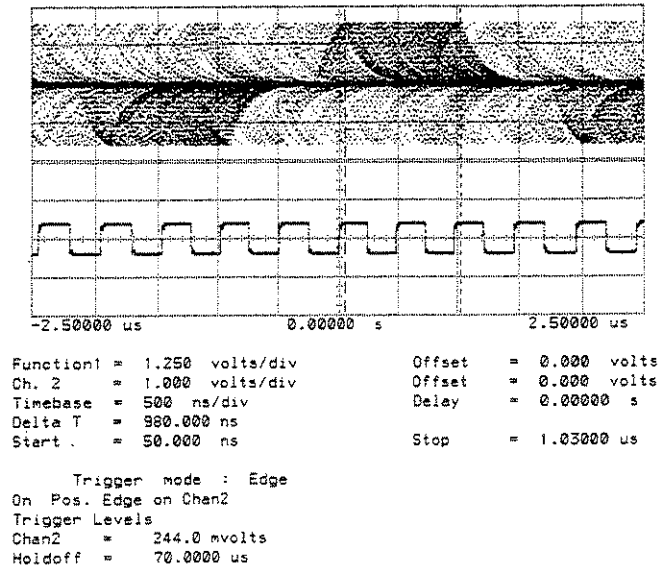

Figure 8-23 10UI p-p Jitter

27. Increase the Signal Source frequency to 2.4 kHz. You may have to adjust the output level to ensure the jitter shown on Channel A is still 10 UI p-p.
28. Increase the Signal Source frequency without altering the output level until the observed jitter falls to 8 UI as shown in Figure 8-22. Check that this occurs at a frequency >3 kHz, typically >10 kHz.
29. Continue increasing the Signal Source frequency until the observed jitter falls to 4 UI p-p as in Figure 8-24. Check that the frequency is >6 kHz, typically > 25 kHz.

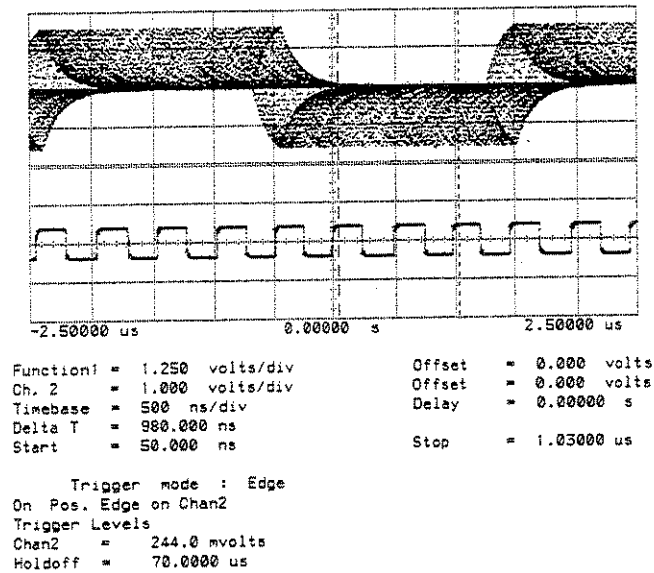

Figure 8-24 4UI p-p Jitter

30. Continue increasing the Signal Source frequency until the observed jitter falls to 2 UI p-p as in Figure 8-25. Check that the frequency is > 12 kHz (typically this will be >40 kHz).

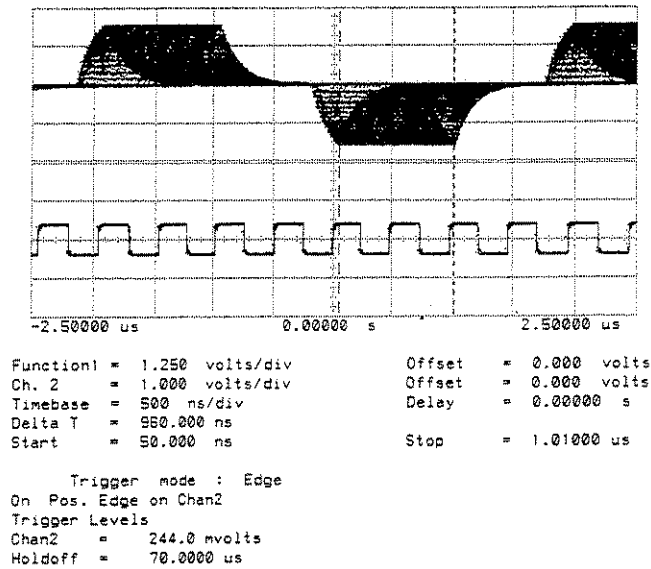

Figure 8-25 2UI p-p Jitter

31. Now set the frequency to 100 kHz and check that the observed jitter is > 0.5 UI p-p, see Figure 8-19.
32. Repeat steps 23-31 for the Transmitter settings of Clock [STD RATE][8MHz] and [34MHz] respectively, setting the Signal Source to the frequencies shown in Table 8-20.

Table 8-20. Minimum Input Frequency (typical) v Jitter

Data rate (Mb/s)	10(UI)	8(UI)	4(UI)	2(UI)	0.5(UI)
8	10.7kHz	13kHz (>60)	26kHz (>120)	52kHz (>190)	400 kHz
34	1kHz	1.25kHz (>130)	2.5kHz (>425)	5kHz (>540)	800 kHz

8.29 Int Mod and Demod Jitter Measurement In (Opt 002)

DESCRIPTION

This test verifies the accuracy of the Tx Internal Modulation facility at a number of different amplitudes and frequencies. In addition it verifies the Rx Demodulated Jitter Out port and the Rx Measurement In port.

The complete range of jitter generation and jitter measurements is verified to specification using the HP3784A internal Self Test routines.

SPECIFICATION

Internal Modulation P-P jitter amplitude and modulating frequencies
in accordance with CCITT Recommendation O.171.

Demodulated Jitter Output

Bandwidth..... As per Measurement Ranges after measurement filtering is applied.
Accuracy As per measurement accuracy
Amplitude (Range 1).....1.0V/UI (p-p values)
Amplitude (Range 10).....0.1V/UI (p-p values)
Impedance..... nominal voltage source

Measurement In Port

Impedance..... nominal 1kHz

TEST EQUIPMENT

OscilloscopeSee Table 8-1
Universal CounterHP 5335A
Voltmeter.....HP 3478A
Pulse Shape Network See Test 4.28
Blocking Capacitor HP 10240B

PROCEDURE

1. Connect the test equipment as shown in Figure 8-26

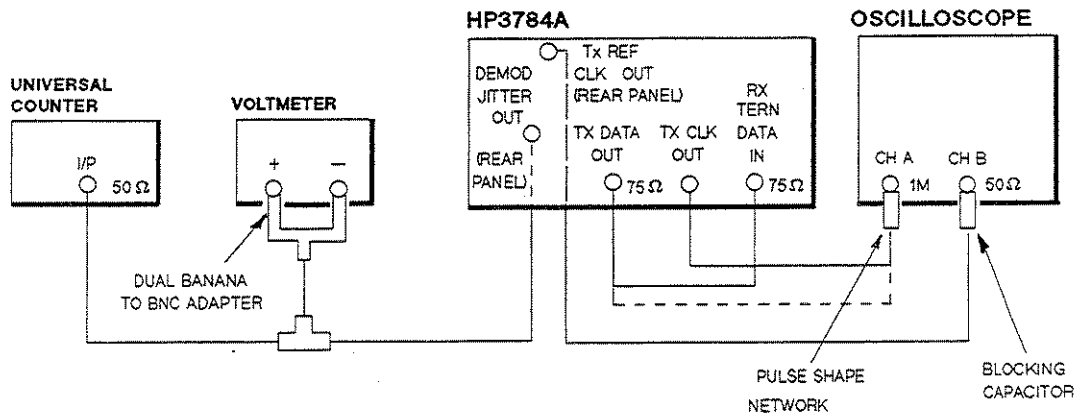

Figure 8-26 Internal Modulation Test Set-up

2. Select HP 3784A Page 1 Preset Panel on the HP 3784A and set the instrument to its Default Settings.
3. Select Page 2 Tx Setup and set the [STD RATE] to [2 MHz].
4. Select Page 4 [JITTER TRANSFER FN] and set to Modulation [INTERNAL], Tx Jitter Amplitude p-p [0 REF].
5. Set the Oscilloscope to trigger on Channel B and adjust the pulse shape network to obtain a display as shown in Figure 8-27.

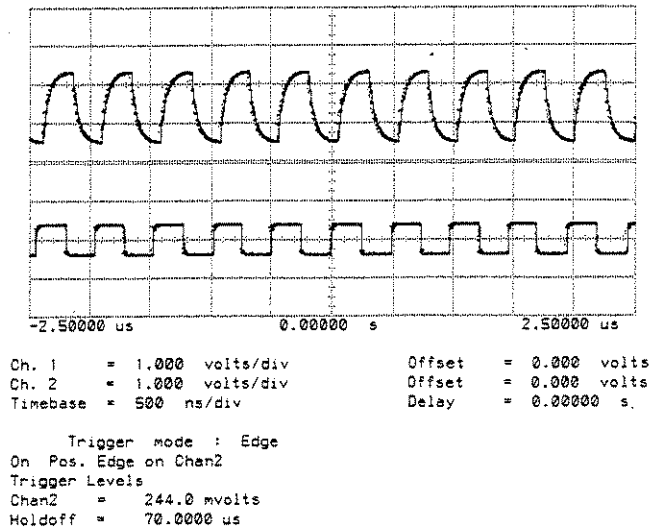

Figure 8-27 Pulse Shape Network Adjustment

- Gradually increase the Tx Jitter Amplitude P-P field on Page 4 [JITTER TRANSFER FN] from [0 REF] until the first overlap point can be seen on the Oscilloscope (this indicates that 1UI p-p of jitter has been added to the Tx output).
Figure 8-28 shows the pre-overlap point.

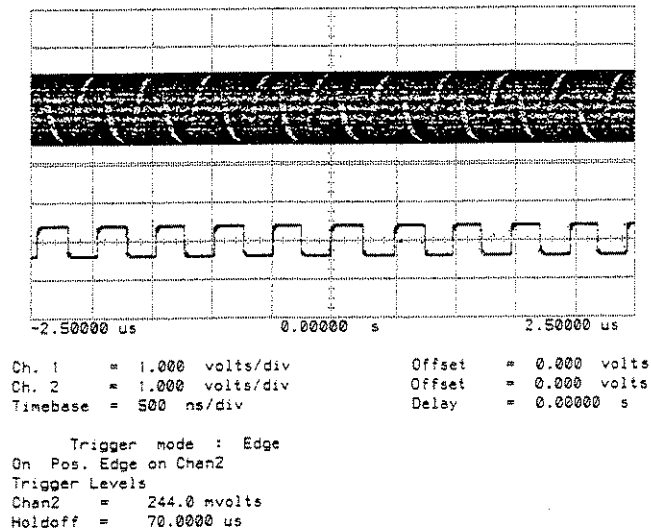

Figure 8-28 1UI p-p Jitter Pre-overlap Point

- Check that the Tx Jitter Amplitude p-p field on Page 4 [JITTER TRANSFER FN] indicates a reading of between 0.9UI and 1.1UI p-p.
- Also check that the Voltmeter reading is between 21.2 and 49.5mV AC rms and that the counter frequency reading is 1.00kHz
- Disconnect the HP 3784A Tx CLOCK OUT port and connect the TX DATA OUT port to Channel A of the Oscilloscope. Leave the TX DATA OUT connected to RX TERNARY DATA IN.
- Select Page 2 Tx Setup and set to Clock Rate [8 MHz] and Pattern [WORD] [4]Bit [1000].

- Reselect Page 4 [JITTER TRANSFER FN] and set to Modulation [INTERNAL] [400HZ] with the Tx Jitter Amplitude P-P field reset to [0 REF]. Check that the Oscilloscope display is as shown in Figure 8-29 (adjust the pulse shape network to obtain the desired waveshape on channel A of the Oscilloscope).

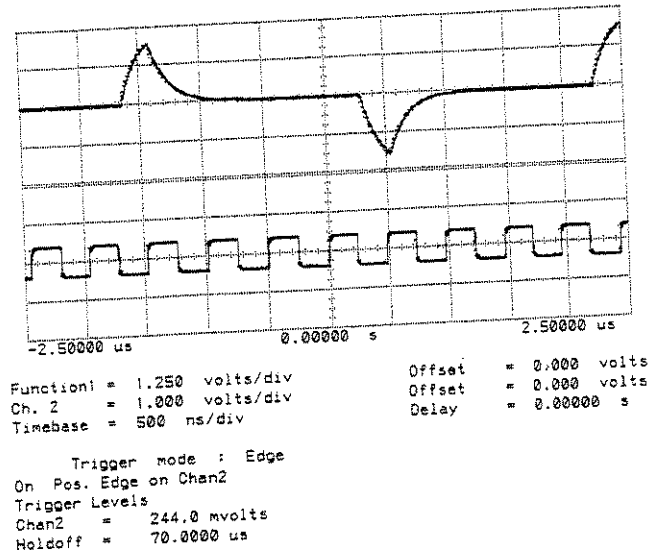

Figure 8-29 Pulse Shape Network Adjustment (Data Output)

- Adjust the Tx Jitter Amplitude P-P field on Page 4 [JITTER TRANSFER FN] until the Tx DATA OUT waveform overlaps itself as shown in Figure 8-30

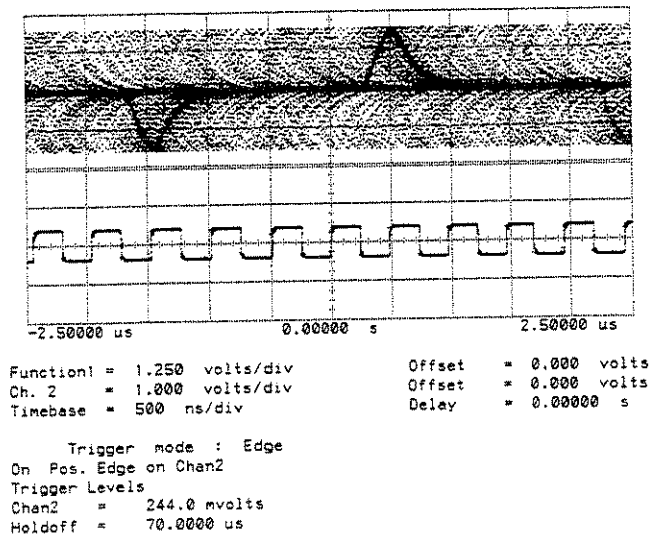

Figure 8-30 8UI p-p Jitter

13. Check that the Tx Jitter Amplitude P-P field on Page 4 [JITTER TRANSFER FN] now reads between 7.5 and 8.5UI p-p, the Voltmeter reading is between 257 and 309mV rms, and the Counter reading is 400Hz.
14. Disconnect the Voltmeter, Counter and Oscilloscope.
Connect the HP 3784A Tx REF CLOCK OUT port to the HP 3784A Rx REF CLOCK IN/OUT port (Note : both ports are on the rear panel).
15. Select Page 10 Rear Panel Ports and set to Rx Reference Clock [EXT].
Connect the HP 3784A Tx DATA OUT port to the Rx TERNARY DATA IN port.
16. Select Page 2 Tx Setup and set to Clock Rate [2MHz].
17. Select Page 4 [JITTER TRANSFER FN] and set to
Modulation [INTERNAL] [2.4KHz]
TX JITTER AMPLITUDE P-P [1.00]UI.

Check that the Rx Jitter [PK-PK][OFF] reading is between 0.62 and 1.38UI p-p.
18. On Page 4 [JITTER TRANSFER FN] set the Rx Range to [1] and the Tx Jitter Amplitude P-P field to [0.50]UI.

Check that the Rx Jitter [PK-PK][OFF] reading is between 0.435 and 0.565
19. Select Page 10 Rear Panel Ports and set Measurement In to [ENABLE].
Reselect Page 4 [JITTER TRANSFER FN] and verify that the Rx Jitter [PK-PK][OFF] reading is < 0.05UI.
20. Connect the DEMOD JITTER OUT port to the MEASUREMENT IN port (both on the rear panel).
21. On Page 4 [JITTER TRANSFER FN] check that the Rx Jitter [PK-PK][OFF] reading is once again between 0.435 and 0.565
22. Disconnect all test equipment.

8.30 Performing Jitter Self Tests (Option 002)

Description

The Jitter Self Tests are designed to verify the operation of the transmitter jitter modulation circuitry and receiver measurement circuitry, the input filters and the rear panel demodulated jitter output amplitude.

There are four separate Jitter Self Tests which may be performed separately or together.

1. Jitter Range Clock Test

Jitter at 100 Hz is applied to each transmitted clock rate in turn and measured on the received clock signal. The jitter amplitude is measured with the transmitter set to 0 REF, 3 UI, 6UI and 9 UI and the P-P, positive P and negative P values are checked against the specification.

For jitter amplitudes less than or equal to 1 UI, the Receiver range is set to [1]. For jitter amplitudes between 1 and 10 UI, the range is set to [10].

The transmitter jitter amplitude is also checked against the value requested by the "operator"

2. Jitter Range Data Test

Jitter is applied to the transmitted "1000" WORD pattern ternary data signal and measured at the receiver.

The jitter frequency is set to one value within the range of each one of the five internal jitter modulation ranges.

3. Frequency Modulators and Jitter Hit Threshold Test

In this test, the transmitter modulator frequencies are checked for accuracy against the customer specification.

Jitter is applied to the 34.368 Mb/s clock signal and measured at the receiver. A hit threshold is set at the receiver and the transmitter amplitude is set above this value so that a single hit is recorded each time the demodulated signal goes above or below the threshold i.e. twice every period. From the number of hits recorded in a set gating period, the jitter frequency can be calculated.

The second part of the test is designed to check the accuracy of the hits threshold detector. Jitter at 1 kHz is applied to a 34.368 Mb/s signal. At the receiver, hits thresholds of 0.2, 2.0 and 4 UI are selected in turn. The transmitter jitter amplitude is varied above and below this threshold and the number of hits monitored.

4. Jitter Filters Test

The 3 dB cut-off points of the filters are checked. Jitter of 0.5 UI p-p is applied to the transmitter at carefully selected modulation frequencies. Chosen to be the 3 dB point frequencies. First, a reference reading is taken without any filtering, then with each of LP, HP1 and HP2 selected. The ratios of the first reading to the latter three are then tested to be within limits specified in tables of constants. This is repeated for each of the instrument clock rates.

Procedure

1. Connect HP 3784A TX DATA OUT port to RX TERNARY DATA IN port and TX CLOCK OUT port to RX CLOCK IN port.
2. Select Page 1 Preset Panel and set the instrument to its default settings.

All Jitter Tests

3. Select Page 12 Self Tests and set to Function[JITTER TESTS]

Ensure front panel connections are correct (as in step 1) and press the **EXEC** key to initiate the self tests.

The complete routine will take approximately 15 minutes to complete. If any test fails, a FAIL CODE will be displayed on the instrument front panel. Refer to Appendix F for details of the problem. The transmitter and receiver settings will remain at the configuration where the self tests failed. This enables you to refer to Page 2 Tx Setup and Page 3 Rx Setup to locate the failure point.

8.31 Thrudata (Option 002)

Description

Jitter can be added to a signal applied in the THRUDATA mode. The signal, from an external source, is input to the RX TERN DATA IN port and jitter is added within the limits specified by CCITT REC O.171 jitter masks. The signal pattern and coding format are unchanged by the addition of jitter.

This test is in two parts. The first verifies the error free performance of the THRUDATA mode as data is shifted in and out of the buffer store and the second verifies that the correct levels of jitter are added to the jitter free input.

Specification

Jitter can be added to an external signal applied to the receiver data input interface. The pattern and format of the signal are unchanged by the Thrudata mode.

Equipment

Pattern Generator See Note:
Error Detector See Note:
Oscilloscope See Table 8-1

Note: Suitable Model Numbers are the HP 3781A/3782A, the HP 3780A, the HP 3764A (OPT 001), or the HP 3784A.

Procedure

1. Connect the equipment as shown in Figure 8-31

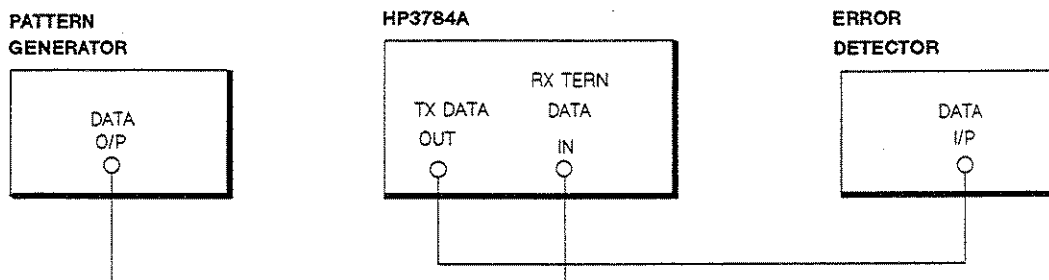

Figure 8-31 Thrudata Test Set-up

2. Select Page 1 Preset Panel and set the HP 3784A to its default settings.
3. Select HP 3784A Page 2 Tx Setup and set to the following:

```
2 Tx Setup:   Data Out [75 TERM] [HDB3]
Clock Rate[ 2 MHz]
Pattern [THRUDATA]
                Clock Out [NORM]
```

4. Set the Pattern Generator to output a HDB3 coded ternary PRBS pattern at 2.048 Mb/s.
5. Set the Error Detector to measure Bit Errors on the incoming HDB3 coded ternary PRBS pattern at 2.048 Mb/s.
6. Select HP 3784A Page 4 [JITTER TRANSFER FN] and set to the following:

```

4 [JITTER TRANSFER FN]   Rx Range [10]
Modulation [ INTERNAL ]..... [1.00KHz]
Tx Jitter Amplitude P-P..... [0 REF]UI
Rx Jitter [ PK-PK ] [OFF]..... 0.01 UI

```

7. Start the Error Detector gating and verify that no Bit errors are detected.
8. Now connect the equipment as shown in figure 8-32

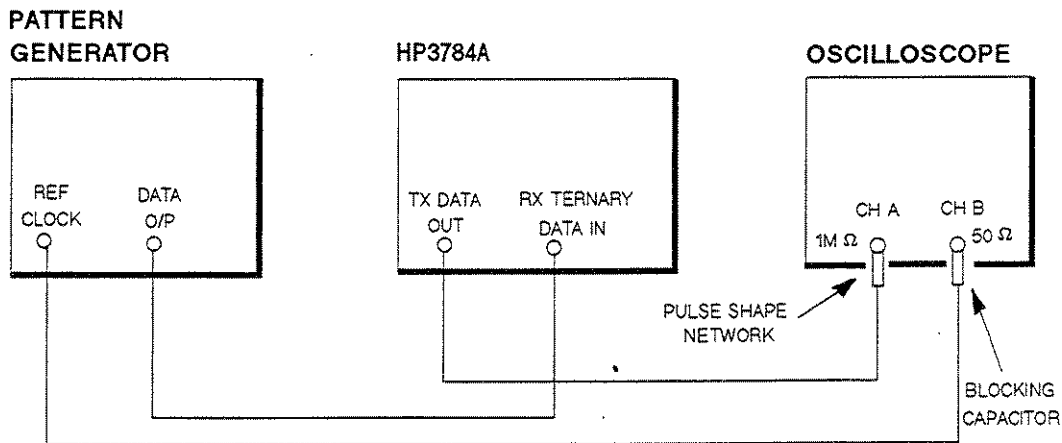

Figure 8-32 Thru-data Jitter Application

9. Set the Pattern Generator to output a 1000 4-bit WORD pattern at 2.048 Mb/s.
10. On Page 4 [JITTER TRANSFER FN] of the HP 3784A, position the cursor on Tx Jitter Amplitude P-P [0 REF] and slowly increase the level of jitter, observing the output on the oscilloscope display.

- When the display is at the overlap point, as shown in Figure 8-33, verify the Tx Jitter Amplitude reading is between [7.9 UI] and [8.1 UI] p-p.

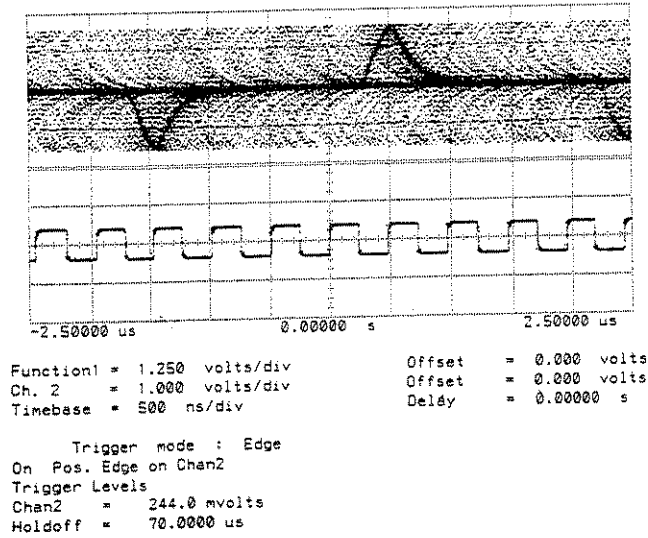

Figure 8-33 8UI p-p Jitter

- Decrease the level of jitter until the signal on the oscilloscope display is as shown in Figure 8-34.

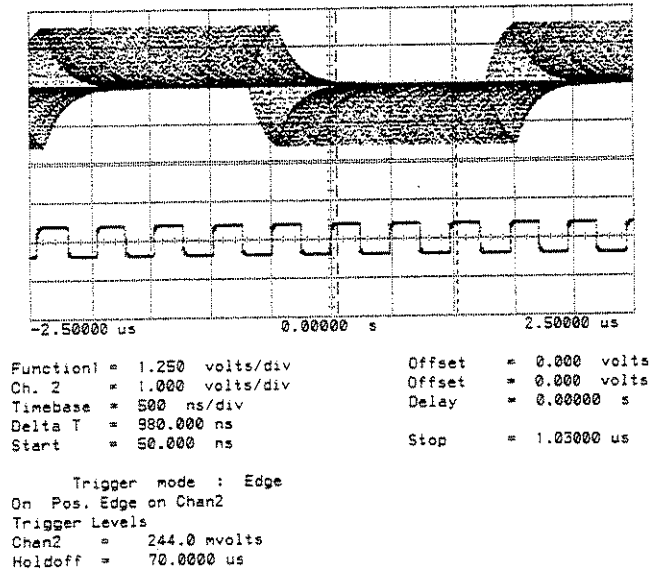

Figure 8-34 4UI p-p Jitter

Verify that the Tx Jitter Amplitude reading is between [3.9 UI] and [4.1 UI] p-p.

- Disconnect all the test equipment

8.32 64 kbit/s Co-directional Interface (Option 006)

DESCRIPTION

The HP 3784A 64 kbit/s Co-directional Interface Output is checked on an Oscilloscope to ensure the Transmitter pulse shape and coding is correct.

The HP 3784A is then connected back to back to ensure that the Receiver input stage is functioning correctly and to verify that the instrument is correctly detecting bit errors.

SPECIFICATION

Transmitter Interface.....	Binary ECL/TTL or Co-directional
Binary Interface	As standard instrument
Co-directional Interface	
Pulse Shape	As CCITT G.703 Figure 5
Coding	As CCITT G.703 Figure 4
Receiver Interface.....	Binary ECL/TTL or Co-directional
Receiver Rate Tolerance (Co-directional only).....	± 120 ppm
Monitor Mode.....	Automatic gain control of up to 30 dB

TEST EQUIPMENT

Oscilloscope.....	See Table 8-1
120 Ω Balanced to Twin BNC Pair	See Figure 8-36
120 Ω Balanced to 120 Ω Balanced Cable	HP15512A
Termination Network	See Figure 8-35

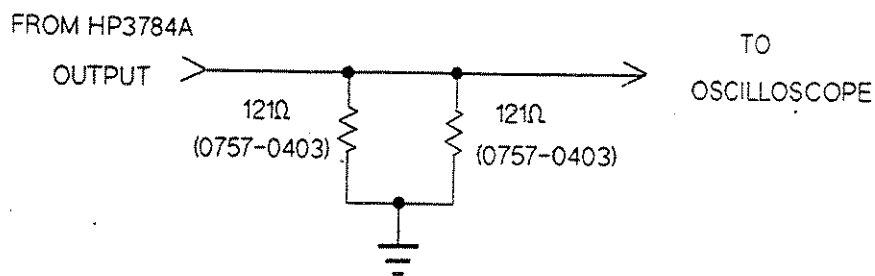

Figure 8-35 Termination Network

PROCEDURE

1. Connect the equipment up as shown in Figure 8-36.

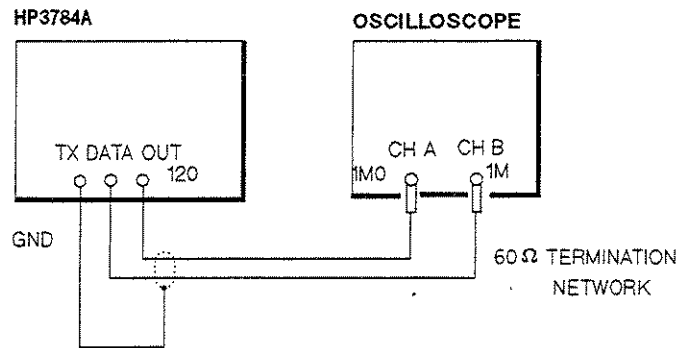

Figure 8-36 64 kbit/s Pulse Shape Test Setup

2. Select Page 1 Preset Panel on the HP 3784A and press the EXEC key set the instrument to its Default Settings.
3. Select Page 2 Tx Setup and set to the following (Note: set the Clock [STD RATE] field first).

```
2 Tx Setup:      Data Out [CO-DIR] [-OCT]
Clock [STD RATE] [64 KHz] Offset [ +0]ppm
Pattern [WORD] [ 4]Bit [0000      ]
Er Add [ OFF]      Clock Out [NORM]
```

Pulse Shape

4. Adjust the Oscilloscope to obtain positive pulse as shown in Figure 8-37

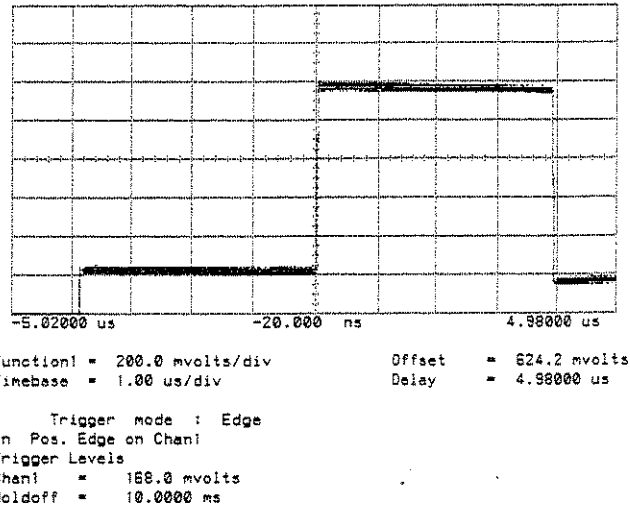

Figure 8-37 Isolated Positive Pulse

5. Check the pulse has the following characteristics.

Pulse Amplitude = $1.0 \text{ V} \pm 0.1 \text{ V}$ (measured at the center of the pulse)

Overshoot $\leq 0.2 \text{ V}$
 Undershoot $\leq 0.2 \text{ V}$

Pulse Width = $3.9 \text{ uS} \pm 0.4 \text{ uS}$ (measured at mid amplitude)

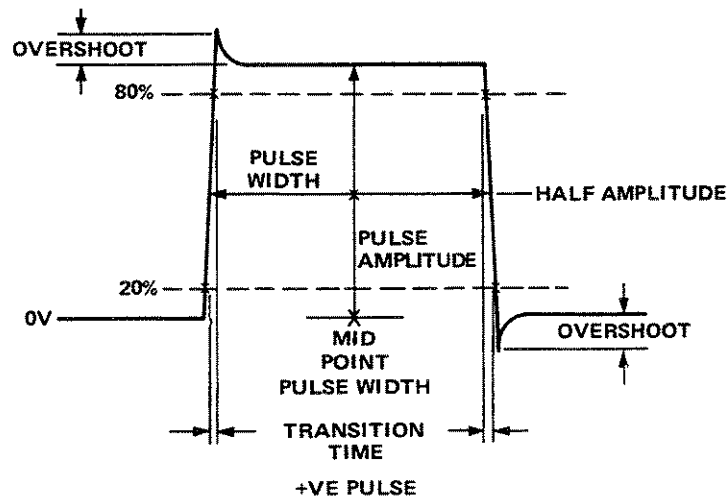

Figure 8-38 Pulse Characteristics

- Adjust the Oscilloscope to obtain an isolated negative pulse as shown in Figure 8-39 and repeat step 5.

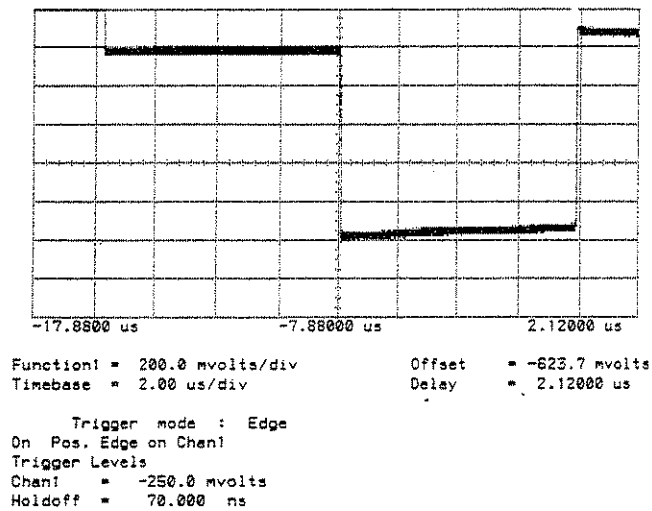

Figure 8-39 Isolated Negative Pulse

Coding

- Re-adjust the Oscilloscope controls and check the display is as shown in Figure 8-40.

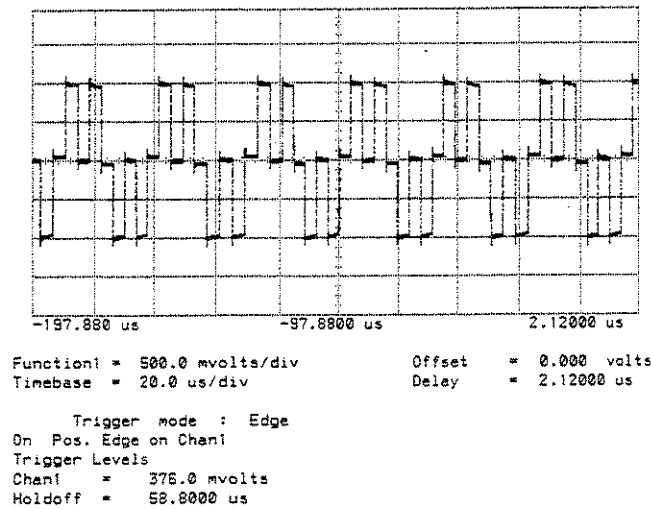

Figure 8-40 64 kbit/s Coded Output

- On Page 2 Tx Setup set to Data Out [CO-DIR][+OCT] Pattern [WORD][4]Bit [1111].

9. Check the Oscilloscope display is now as shown in Figure 8-41.

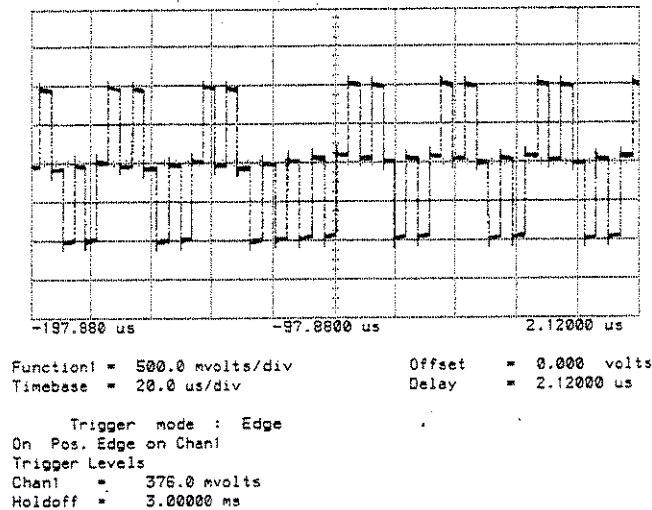

Figure 8-41 64 kbit/s Octet Timing

10. Disconnect the HP 3784A TX DATA OUT 120 Ω BAL output from the Oscilloscope and connect it to the RX DATA IN 120 Ω BAL input using a suitable cable.
11. On Page 2 Tx Setup set to Er Add (bit) [MAN].
12. Select Page 4 [ERROR RESULTS] and press the MEASURE START/STOP key to start the measurement gating.
13. On Page 4 [ERROR RESULTS], check the Rx Bit Error [COUNT] increments by one each time the front panel ERROR ADD key is pressed.
14. Press the MEASURE START/STOP key to stop the gating period.
15. Connect the HP 3784A TX CLOCK OUT port to the RX CLOCK IN port and the TX DATA OUT port to the RX BIN DATA IN port.
16. On Page 2 Tx Setup set to Data Out [BINARY] [TTL] and repeat steps 12 to 14.
17. On Page 2 Tx Setup set to Data Out [BINARY] [ECL] and repeat steps 12 to 14.
18. Disconnect all cabling.

Table 8-21 Performance Test Record

Hewlett-Packard Model No 3784A		Tested By		
		Date		
		Serial No		
Para No.	Test Description	Result		
		Min.	Actual	Max.
8.9	EXTERNAL CLOCK			
(4)	Tx CLOCK IN led on		PASS/FAIL	
	Counter frequency display	999		1001
	Counter duty cycle display	44		56
(5)	Tx CLOCK IN led on		PASS/FAIL	
	Counter frequency display	999		1001
(6)	Tx CLOCK led on at all frequencies		PASS/FAIL	
	Instrument frequency display correct at all frequencies		PASS/FAIL	
	Counter frequency display correct at all frequencies		PASS/FAIL	
	Counter duty cycle correct at all frequencies		PASS/FAIL	
(10)	Tx CLOCK IN led on at all frequencies		PASS/FAIL	
	Counter reading correct at all frequencies		PASS/FAIL	
8.10	INTERNAL CLOCK AND FREQUENCY OFFSET			
(3)	Duty cycle 44 to 56% at all frequencies		PASS/FAIL	
	Counter reading at 0.7MHz	703997		704003
	2MHz	2047994		2048006
	8MHz	8447976		8448024
	34MHz	34367898		34368102
(5)	Clock frequency accuracy correct at all frequencies		PASS/FAIL	
	SYNTH UNLOCK led gives correct indication at all frequencies		PASS/FAIL	

Table 8-21 Performance Test Record (Cont)

Para No.	Test Description	Result		
		Min.	Actual	Max.
(6)	Counter reading for offset of	34364495		34364701
	-99ppm	34367211		34367415
	-20ppm	34367726		34368070
	-5ppm	34367898		34368102
	0ppm	34368104		34368308
	6ppm	34369616		34369820
	50ppm	34371300		34371504
	99ppm			
8.11	BINARY CLOCK AND DATA OUTPUTS			
(4)	Signal levels and duty cycle correct		PASS/FAIL	
(5)	Inverted clock output correct		PASS/FAIL	
(7)	Binary ECL clock and data output levels correct		PASS/FAIL	
(9)	Data output frequency 1.024MHz	1023000		1025000
(10)	Duty cycle 44 to 56% at all frequencies		PASS/FAIL	
	Counter reading for input 1MHz	499998		500002
	10MHz	4999985		5000015
	50MHz	24999925		25000075
8.12	TRANSMITTER n-BIT PROGRAMMABLE WORD			
(4)	Counter reading correct for each word		PASS/FAIL	
8.13	TRANSMITTER PATTERN TRIGGER			
(3)	Counter reading (8 bit word) 4.296MHz	4295088		4296012
(4)	Counter reading (16 bit word) 2.148MHz	2147094		2148006
(7)	Oscilloscope display of 6 bit word correct		PASS/FAIL	
(10)	Rx REF CLOCK output 2.048MHz	2047994		2048006

Table 8-21 Performance Test Record (Cont)

Para No.	Test Description	Result		
		Min.	Actual	Max.
8.14	TRANSMITTER PRBS PATTERN VERIFICATION			
(4)	Counter ratio reading correct for each PRBS		PASS/FAIL	
(6)	Counter reading correct for each PRBS		PASS/FAIL	
(7)	Counter reading correct for all zerosub values		PASS/FAIL	
8.15	TRANSMITTER ALTERNATING WORD			
(5)	Counter readings correct for 1V p-p input		PASS/FAIL	
(6)	Operation correct with 600mV, 1kHz input		PASS/FAIL	
(7)	Operation correct with 3V, 1kHz input		PASS/FAIL	
8.16	TERNARY DATA OUTPUTS			
(5)	Positive Pulse amplitude (34MHz) Transition time Overshoot	0.9V		1.1V 5ns 0.1V
(6)	Negative Pulse amplitude (34MHz) Transition time Overshoot	- 0.9V		- 1.1V 5ns 0.1V
(7)	+ve/-ve amplitude ratio	1.05:1		1:0.95
(9)	Positive Pulse amplitude (8MHz) Transition time Overshoot +ve/-ve amplitude ratio	2.14V 1.05:1		2.6V 5ns 0.1V 0.95:1
	Negative Pulse amplitude (8MHz) Transition time Overshoot +ve/-ve amplitude ratio	- 2.14V 1.05:1		- 2.6V 5ns 0.1V 0.95:1

Table 8-21 Performance Test Record (Cont)

Para No.	Test Description	Result		
		Min.	Actual	Max.
(11)	Positive Pulse amplitude (2MHz)	2.14V		2.6V
	Transition time			5ns
	Overshoot			0.1V
	+ve/-ve amplitude ratio	1.05:1		0.95:1
	Negative Pulse amplitude (2MHz)	- 2.14V		- 2.6V
	Transition time			5ns
	Overshoot			0.1V
	+ve/-ve amplitude ratio	1.05:1		0.95:1
(13)	Positive Pulse amplitude (704kHz)	2.14V		2.6V
	Transition time			5ns
	Overshoot			0.1V
	+ve/-ve amplitude ratio	1.05:1		0.95:1
	Negative Pulse amplitude (704kHz)	- 2.14V		- 2.6V
	Transition time			5ns
	Overshoot			0.1V
	+ve/-ve amplitude ratio	1.05:1		0.95:1
(16)	Positive Pulse amplitude (120 ohms)	2.14V		2.6V
	Transition time			10ns
	Overshoot			0.1V
	+ve/-ve amplitude ratio	1.05:1		0.95:1
	Negative Pulse amplitude (120 ohms)	- 2.14V		- 2.6V
	Transition time			10ns
	Overshoot			0.1V
	+ve/-ve amplitude ratio	1.05:1		0.95:1
(18)	Positive Pulse amplitude (2MHz,120 ohms)	2.14V		2.6V
	Transition time			10ns
	Overshoot			0.1V
	+ve/-ve amplitude ratio	1.05:1		0.95:1
	Negative Pulse amplitude (2MHz,120 ohms)	- 2.14V		- 2.6V
	Transition time			10ns
	Overshoot			0.1V
	+ve/-ve amplitude ratio	1.05:1		0.95:1
(20)	AMI Waveform correct		PASS/FAIL	
(22)	HDB3 Waveform correct		PASS/FAIL	

Table 8-21 Performance Test Record (Cont)

Para No.	Test Description	Result		
		Min.	Actual	Max.
8.17	BIT AND CODE ERROR ADD			
(4)	Counter reading correct for each rate		PASS/FAIL	
(7)	ERROR ADD key produces errors		PASS/FAIL	
(10)	Code error add operates correctly		PASS/FAIL	
8.18	RECEIVER BINARY DATA AND CLOCK			
(5)	Rx CLOCK IN led ON at all frequencies		PASS/FAIL	
	BIT ERRORS, CODE ERRORS, and SYNC LOSS , leds OFF at all frequencies		PASS/FAIL	
(6)	BIT ERRORS, CODE ERRORS, and SYNC LOSS , leds OFF		PASS/FAIL	
(7)	BIT ERRORS, CODE ERRORS, and SYNC LOSS , leds OFF		PASS/FAIL	
8.19	RECEIVER CLOCK RECOVERY			
(5)	BIT ERRORS and SYNC LOSS leds OFF at all frequencies		PASS/FAIL	
(7)	BIT ERRORS and SYNC LOSS leds OFF at all frequencies		PASS/FAIL	
8.20	TERNARY DATA INPUT LEVELS			
(4)	Rx Bit and Code Error count zero at 34MHz		PASS/FAIL	
(5)	Rx Bit and Code Error count zero at 8MHz, 2MHz and 704kHz		PASS/FAIL	
(8)	Alarm leds extinguished with 30dB attenuation		PASS/FAIL	
(9)	Rx Bit and Code Error count zero at 704kHz with 30dB attenuation		PASS/FAIL	
(10)	Rx Bit and Code Error count zero at 34MHz, 8MHz and 2MHz with 30dB attenuation		PASS/FAIL	

Table 8-21 Performance Test Record (Cont)

Para No.	Test Description	Result		
		Min.	Actual	Max.
8.21	REFERENCE WORD AND SYNCHRONIZATION			
(5)	Rx CLOCK IN led is ON		PASS/FAIL	
(6)	All alarm leds are OFF		PASS/FAIL	
(8)	All alarm leds are OFF		PASS/FAIL	
(9)	SYNC LOSS led is OFF		PASS/FAIL	
(10)	SYNC LOSS led is ON		PASS/FAIL	
(11)	SYNC LOSS led is OFF		PASS/FAIL	
8.22	RECEIVER REFERENCE PRBS PATTERNS AND ZEROSUBSTITUTION			
(5)	Front Panel ALARM leds OFF		PASS/FAIL	
(6)	Front Panel ALARM leds OFF for all PRBS patterns		PASS/FAIL	
(9)	Front Panel ALARM leds OFF for [032] zerosub settings		PASS/FAIL	
(10)	Front Panel ALARM leds OFF for all PRBS/zerosub settings		PASS/FAIL	
8.23	RECEIVER AUTOCONFIGURE AND AIS INDICATION			
(5)	Receiver autoconfigures to all data configurations		PASS/FAIL	
(10)	AIS led is ON		PASS/FAIL	
(11)	AIS led is OFF		PASS/FAIL	
8.24	MEASUREMENT GATING AND POWER LOSS ALARM			
(4)	START/STOP indicator led comes ON		PASS/FAIL	
(5)	Error result displayed correctly. START/STOP indicator OFF		PASS/FAIL PASS/FAIL	
(8)	Period count operates correctly	34367		34369

Table 8-21 Performance Test Record (Cont)

Para No.	Test Description	Result		
		Min.	Actual	Max.
8.25	ERROR OUT			
(4)	BIT ERROR alarm led ON. Bit error frequency correct		PASS/FAIL PASS/FAIL	
(5)	No code error output with no code errors		PASS/FAIL	
(6)	Code error frequency correct		PASS/FAIL	
(7)	Error output waveform correct		PASS/FAIL	
8.26	RECEIVER ERROR DETECTION AND MEASUREMENT			
(6)	Bit error ratio measured correctly		PASS/FAIL	
(10)	Code error ratio measured correctly		PASS/FAIL	
(12)	CODE ERRORS led illuminated Code error ratio measured correctly		PASS/FAIL PASS/FAIL	
8.27	HP-IB VERIFICATION			
(1)	Data transfer successful		PASS/FAIL	
8.28	EXTERNAL MODULATION INPUT			
(5)	Positive input shifts clock output	5.05 cycles		
(7)	Negative input shifts clock output	5.05 cycles		
(9)	Positive input shifts 8MHz clock output Negative input shifts 8MHz clock output	5.05 cycles 5.05 cycles		
(11)	Positive input shifts 34MHz clock output Negative input shifts 34MHz clock output	5.05 cycles 5.05 cycles		
(16)	Input level for 0.5UI p-p jitter at 100kHz			1.5V
(18)	Input level for 0.5UI p-p jitter at 400kHz			1.5V

Table 8-21 Performance Test Record (Cont)

Para No.	Test Description	Result		
		Min.	Actual	Max.
(19)	Input level for 0.5UI p-p jitter at 800kHz 2MHz RATE			1.5V
(28)	Input frequency for 8UI	3kHz		
(29)	Input frequency for 4UI	6kHz		
(30)	Input frequency for 2UI	12kHz		
(31)	Jitter with 100kHz input 8MHz RATE	0.5UI		
(32)	Input frequency for 8UI Input frequency for 4UI Input frequency for 2UI Jitter with 400kHz input 34MHz RATE	13kHz 26kHz 52kHz 0.5UI		
(32)	Input frequency for 8UI Input frequency for 4UI Input frequency for 2UI Jitter with 800kHz input	1.25kHz 2.5kHz 5kHz 0.5UI		
8.29	INT MOD AND DEMOD JITTER/MEASUREMENT IN (OPTION 002)			
(7)	Clock output jitter amplitude	0.9UI		1.1UI
(8)	Demod jitter amplitude Demod jitter frequency 1kHz	21.2mVrms	PASS/FAIL	49.5mVrms
(13)	Data output jitter amplitude Demod jitter amplitude Demod jitter frequency 400Hz	7.5UI 257mVrms	PASS/FAIL	8.5UI 309mVrms
(17)	Rx jitter OFF reading for 1.0UI	0.62UI		1.38UI
(18)	Rx jitter measurement 0.5UI	0.435UI		0.565UI
(19)	Jitter measurement			0.05UI
(21)	Jitter measurement	0.435UI		0.565UI

Table 8-21 Performance Test Record (Cont)

Para No.	Test Description	Result		
		Min.	Actual	Max.
8.30	JITTER SELF TESTS		PASS/FAIL	
8.31	THROUGHDATA			
(7)	No bit errors		PASS/FAIL	
(12)	Tx jitter amplitude for 8UI p-p jitter	7.9UI		8.1UI
(13)	Jitter amplitude for 4UI p-p jitter	3.9UI		4.1UI
8.32	64 kbit/s CO-DIRECTIONAL INTERFACE			
(5)	Positive pulse amplitude	0.9V		1.1V
	Overshoot			0.2V
	Undershoot			0.2V
	Pulse width (mid amplitude)	3.5us		4.3us
(6)	Negative pulse amplitude	0.9V		1.1V
	Overshootn time			0.2V
	Undershoot			0.2V
	Pulse width (mid amplitude)	3.5us		4.3us
(7)	Coded output display correct		PASS/FAIL	
(9)	Octet timing display correct		PASS/FAIL	
(13)	Error Add operates correctly		PASS/FAIL	
(16)	Error Add (binary TTL o/p) operates correctly		PASS/FAIL	
(17)	Error Add (binary ECL o/p) operates correctly		PASS/FAIL	

Introduction

Measurement definitions for both standard and option 002 instruments are given in this appendix.

Measurements:

Four distinct classes of measurement can be performed, namely errors, error analysis, losses and frequency. For the analysis a simple GO / NO GO facility is also provided.

Error Measurements:

When measuring at ternary interfaces bit and code errors can be simultaneously measured. When measuring at binary interfaces only bit errors can be measured. Error measurements be they bit or code can be displayed as any one of four different formats. All four are calculated throughout a measurement although only one result can be displayed at any time. The formats are as follows:

Error Count:

The number of errors counted is totalised during the measurement interval. The result is displayed in integer form to a maximum of 15 digits (ie $10^{15}-1$).

Error Ratio:

The number of errors counted is divided by the maximum number of possible errors for the measurement interval. Receiving the ternary signals the error ratio is based on the selected nominal clock recovery rate. For binary the ratio is based on the measured rx clock frequency.

$$\text{Error Ratio} = \frac{\text{No. of Errors}}{\text{Max. Possible No. of Errors}}$$

The result is displayed in floating point format and is updated every second.

N.N E[^]NN for 1 to 100 errors
N.NNE[^]NN for 101 to 1000 errors
N.NNN E[^]NN for >1000 errors.

Error Intervals:

These can be either Error Seconds or Error Deciseconds (selected prior to measurement). The measurement is asynchronous, that is to say, the Error interval of the real time clock in which one or more errors

occurred. The result is expressed in integer format with a maximum of 15 integers and is updated every time an error interval occurs.

Error Free Intervals:

These can be Error Free seconds or Error Free Deciseconds (selection common with Error Intervals). The measurement is asynchronous, that is to say, the Error Free Interval is the interval of the real time clock in which no errors occurred. The result is expressed in integer format with a maximum of 15 integers and is updated every time an error free interval occurs.

Error Analysis:

Eight different classes of analysis are provided. Those based on CCITT Rec. G.821 are marked with an asterisk thus * and are measured for "Available" time. All the analysis is derived from the Bit error results.

Availability*

The percentage & count of 1 second time intervals in the measurement period for which the error ratio was better than a 1.10^{-3} threshold. The result is expressed as a percentage & count to the following formats:

N.NNNN for 0 to 9.9999%
NN.NNN for 10 to 99.999%
NNN.NN for 100%
NNNNNNN for count.

Note:

- a) A time hysteresis of 10 consecutive seconds is applied, ie periods of Unavailability start after 10 consecutive seconds with an error ratio worse than 1.10^{-3} . These 10 second time intervals are considered to be part of the unavailable time. Similarly, available time starts after the receipt of 10 consecutive seconds with an error ratio better than 1.10^{-3} . These 10 second time intervals are considered to be part of available time.
- b) If the 3784A is flagging any of the following conditions:

AIS
Data Loss (ternary operation)
Rx Clock Loss (binary operation)
Pattern Sync. Loss

then the same criteria will be applied as for error ratio exceeding the 1.10^{-3} threshold.

Unavailability:

This is the converse of Availability and the results are displayed in a similar manner.

Error Seconds*

Calculates the number of errored seconds during the "Available" time and expresses this as a percentage & count of the total "Available" seconds. The result is expressed as a percentage to 2 decimal places or as count in exponent format and is updated every second.

% Severely Errored Seconds*

Calculates the number of seconds during the "Available" time that the error ratio was worse than the Availability threshold (ie 1.10^{-3}) and expresses the answer as a percentage of the total "Available" seconds. The result is expressed in a percentage format to 2 decimal places or as count in exponent format and is updated every second.

A Severely Errored Second can also be caused by any of the following conditions:

AIS
Data Loss (ternary operation)
Rx Clock Loss (binary operation)
Pattern Sync. Loss

Note: By definition only 9 consecutive Severely Errored secs can occur since 10 consecutive SESs crosses the Unavailability threshold.

Degraded Minutes*

The "Degraded Minute" is the ratio of the number of Degraded Minutes to the total "Available" time (excluding "Severely Errored Secs") expressed in whole minutes and as a percentage. Degraded Minutes are computed as follows: The CPU firstly discards all Unavailable time. It then looks at the remaining time and discards all Severely Errored Seconds (ie seconds with a mean BER worse than 1.10^{-3}). The time which is now left is inspected in blocks of sixty 1 second periods and if the overall mean BER of a block is worse than 1.10^{-6} it is deemed a "Degraded Minute".

Error Distribution:

This measurement partitions error seconds (or deciseconds) into those containing:

1 error
2 to 10 errors
>10 errors.

These results are valid for all measurement time, not just "Available" time.

Error Bursts:

This measurement records the total number of error bursts during the gating period. An Error Burst is defined as a group of >100 errors (not necessarily consecutive) occurring in a particular time frame within the gating period. This time frame is defined as starting at the first error in the burst and ending 10 error

free intervals after the last error in the burst. The error free intervals can be selected as seconds or deciseconds prior to the measurement.

Long Term Mean Error Ratio:

The L.T. Mean E.R. is the error ratio for available time after excluding the severely errored seconds.

$$\text{L.T. Mean Error Ratio} = \frac{\text{No. of Errors } E}{\text{Bit Rate} * \text{No. Of Non S.E.S.}}$$

Where E are the errors recorded during the non S.E.S.s, and S.E.S are severely errored seconds.

GO/NO GO Tests:

For each of the measurements in the analysis section the user can set a threshold against which the end of measurement result can be compared. (Thresholds not required can be turned off.) The results are compared with threshold values and if worse flags a FAIL. An overall PASS/FAIL result is also provided.

Threshold Ranges:

% Availability
% Unavailability
% Errored Seconds
% Severly Errored Secs
% Degraded Minutes All 0.00 to 100.0%

No. of Error Secs with
N errors & Count results &
No. of Error Bursts $0.0*10^{0.0}$ to $9.9*10^9$
L.T.M.E.R $9.9*10^{-1}$ to $1.0*10^{-19}$

Loss Measurements:

The duration of several alarm conditions can be monitored simultaneously with other measurements. These durations with the exception of power loss are displayed to the nearest 0.1 second and in integer format with 9 digits of resolution and for up to 100 days. Power loss is resolved to the nearest second.

Power Loss

This measurement totalises the number of seconds that the power was lost during the gating period. The built-in non-volatile clock provides the means of performing this measurement.

AIS

This measurement counts the number seconds during the gating period that AIS was detected in the receiver.

This detector conforms to CCITT 0.162 i.e. it flags AIS if in 2200 clocks there are less than 3 zeroes.

Sync. Loss:

This measurement counts the number of seconds during the gating period that pattern synchronization was lost.

Criteria:

Sync Gain: Error Ratio $\leq 1/100$

Sync Loss: Error Ratio $\geq 1/9$

Data Loss: (Ternary Mode)

This measurement counts the number of seconds during the gating period that the Data Transitions detection registered no transitions.

Criterion:

Loss = No transitions detected in last 100mS.

Note: No data transitions detection is provided for the Binary Data Input. The RX Clock Loss should be used for Binary applications.

Rx Clock Loss: (Binary & Thru data only)

This measurement counts the number of seconds during the gating period that the Rx Clock Transitions detection registered no transitions.

Criterion:

Loss = No transitions detected in last 100mS.

Tx Clock Loss:

This measurement counts the number of seconds during the gating period that the Tx Clock Transitions detection registered no transitions.

Criterion:

Loss = No transitions detected in last 200mS.

Slip Count

This measurement is available when the receiver is configured to receive a PRBS pattern. For a slip to be recorded, $N + 64$ consecutive clock periods must pass during which the resulting error signal is of the form of any part of the PRBS pattern, i.e. the received signal has time shifted. If one or more slips occurs during a measurement interval (secs or deciseconds) then this will be recorded as one slip (deci)second. (N is the PRBS radix number.) Slips are not counted during periods of signal loss.

Frequency and Offset:

When the 3784A is supplied with a ternary input signal the user can choose to measure frequency offset with respect to the standard bit rate instead of code errors. For binary input signals the 3784A will measure absolute frequency.

Offset Measurement Range:

+/- 999 p.p.m.

Offset Measurement Resolution:

1 p.p.m.

Frequency Measurement Resolution:

1 Hz. (see Binary Input frequency range.)

Accuracy: (Binary or Ternary)

+/-3 p.p.m.

Options

Option 002:

This option adds jitter generation and measurement. It can not be fitted when Option 006 (64 kbit interfaces) is fitted. In addition to the various manual measurements provided by this option the 3784A opt 002 can perform automated tolerance and jitter gain plotting.

If there is a requirement to use the 3784A opt 002 for error testing only, then the jitter option can be deselected on the front panel.

The following specifications should be used in conjunction with the specifications of the standard instrument. Certain restrictions and additions apply to the use of the jitter generation and measurement which do not apply for the pattern generation and error detection and these will be highlighted by the symbol ---.

Automatic Tolerance Plotting:

The 3784A steps through a range of modulation frequencies and at each progressively steps up the jitter amplitude up until the onset of errors is found. The jitter amplitude is then stepped back for no errors and this value plotted.

Automatic Jitter Transfer Function Plotting:

Two functions are provided to achieve the jitter transfer function plotting. The first is a calibration routine which records the received jitter reading for a particular transmitted amplitude and records these values for each frequency in the plot. The second, the plot function, use the same transmitted amplitude values as the calibration and computes the gain value as a ratio of the received values from the two routines for each frequency. The plotted result is the ratio of Tx and Rx amplitude quoted in dBs. The user can select a scale factor of 1dB/division or 10dB/division. The calibration routine need not be run for every plot but will reduce the effects of drift and ageing from the results. The accuracy of this measurement can be assessed by running the calibration routine with the 3784A connected back to back for the chosen interface and then running the plot function. The flatness of the resulting straight line plot represents the error in the measurement.

Standard Tolerance Masks:

Five hard programmed jitter masks are provided covering the three jittered bit rates with high and low Q systems catered for. The masks can be swept transient-free, automatically and their peak to peak jitter amplitudes and modulating frequencies are in accordance with CCITT Rec. G.703 Figures 16, 18 and 20. The masks can be used to control the amplitude at spot frequencies (SPOT MASK) or can be swept automatically in 20% frequency increments and decrements (SWEPT MASK).

Table A-1 Standard Tolerance Masks

Nominal Bit Rate (kHz)	704	2048	8448	34368
A1 (UI p-p)	-	1.5	1.5	1.5
A2 (UI p-p)	-	0.2	0.2	0.15
F1 (Hz)	-	20	20	100
F2 (kHz)	-	2.4(0.093)	10.7(0.4)	1.0
F3 (kHz)	-	18(0.7)	80(3)	10
F4 (kHz)	-	100	400	800

High Q figures shown in ().

Programmable Tolerance Masks:

The user can program masks with any number of break points from 2 to 6. Interpolation of frequencies between break points is assumed to be linear. (i.e. When shown on a log-log plot, straight lines are produced.) The upper and lower frequency limits are given by the values F0 and F4 in the Transmitter Modulation table. The maximum amplitude is also shown in this table.

Receiver Display Rates:

The receiver display rate is always controlled by the display rate selection on the front panel display. For measurements using the internal reference clock the FAST setting is always appropriate. For measurements using an externally applied reference clock the lowest measurable frequency can be extended down to 0.1Hz.

Lowest Frequency:

Fast $\geq 10\text{Mz}$
Med. $\geq 1\text{Hz}$
Slow $\geq 0.1\text{Hz}$

Note: This control is shared with the transmitter when the transmitter is modulated externally.

Internal Filtering:

The internal filters, three for each bit rate, are those specified in CCITT Rec. 0.171 and the appropriate G.700 series recommendations. The filters pre-shape the demodulated jitter before measurement of amplitude or hits analysis and before providing a demodulated jitter output at the rear panel connector. Selection choices are:

OFF/LP/HP1 + LP/HP2 + LP

Note: All filters have a nominal 20dB/decade slope asymptote.

Table A-2 Nominal 3dB Corner Frequencies

Nominal Bit Rate (kHz)	704	2048	8448	34368
High Pass HP1	-	20Hz	20Hz	100Hz
High Pass HP2	-	18kHz	80kHz	10kHz
Low Pass LP	-	100kHz	400kHz	800kHz

Max. Peak-Peak:

The maximum peak to peak result records the maximum peak to peak value registered in the gating interval. Note: peak-peak measurements are intended for repetitive waveforms only.

Hit Count:

The hit count totalises the number of occurrences when the received jitter amplitude exceeds a user settable threshold.

Sensitivity:

Typically $>/+100\text{nS}$ pulse width to count.

Threshold Range:

Range 1: 0.05 to 0.5 UI pk

Range 10: 0.5 to 5.0 UI pk.

Hit Intervals:

The hit count registers the number intervals in which one or more hits occurred. The intervals can be seconds or deciseconds as selected on Gating Period page.

Hit Free Intervals:

The hit free interval count totalises the number of intervals in which no hits occurred. The intervals can be seconds or deciseconds as selected on the Gating Period page.

Measurement In:

The Measurement in port is selected on the Rear Panel Ports page. Selecting Measurement in [ENABLE] disconnects the jitter measurement and hit counting circuitry from the internal demodulated jitter source and connects them to the Measurement in port. This facility allows the user to insert external filters between the Demodulated Jitter Out port and the measurement circuits. Note: Filters with zero insertion loss are assumed when this facility is used.

Warning/Indicator Lamps:

Jitter Unlock

This lamp is illuminated when the jitter measurement reference clock for the receiver has lost synchronism with the applied signal.

Hits

This lamp is illuminated when the demodulated jitter amplitude is greater than the user selected Hit threshold.

Bounds Indicators

When the transmitted or received jitter amplitude exceeds the bounds of the measurement circuits then the display is prefixed by the indication: >BOUNDS. In the receiver measurement the indication will be displayed if any of the conditions, positive peak, negative peak or peak to peak exceeds their bounds.

- Alrm Dur. : Alarm Durations.
- AMI : Alternate Mark Inversion (often called "bi-polar" coding) is a form of ternary data in which data "marks" (normally representing "1"s) are alternately positive and negative. The main advantages of this basic code are that the average dc potential on the line is zero and, that this code can be used to detect if one data bit has been changed during transmission (as two consecutive bits would then have the same polarity). (See Figure B-1).

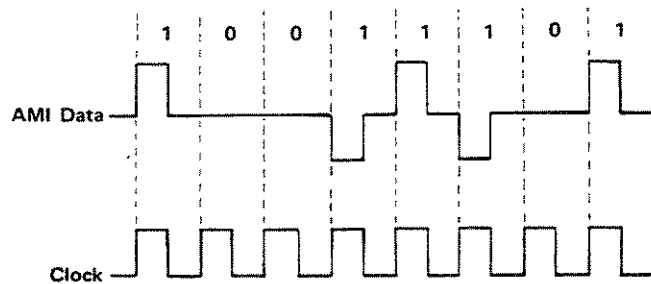

Figure B-1 AMI Data/Clock

- Analysis : A set of results which are derived from the bit error measurement of the HP 3784A and further processed, as per CCITT Rec. G821.
- Audio : An audible tone generated by the HP 3784A in response to measured errors, jitter hits or alarms.
- CCITT : The International Telegraph and Telephone Consultative Committee - an international organization concerned with devising and proposing recommendations for international telecommunications.
- Data Log : A record of the results of measurements performed by the HP 3784A.
- Gating Period : The time interval over which a set of measurements is to be performed.
- H CNT EXP : Hit count exponent.

HDB3

: High Density Bipolar 3 (HDB3) is a code in which a pattern is substituted for each block of four consecutive zeros in the data stream. The substitution contains a bipolar violation which can be recognised at the receive terminal decoder and the substitution removed. (See Figure B-2).

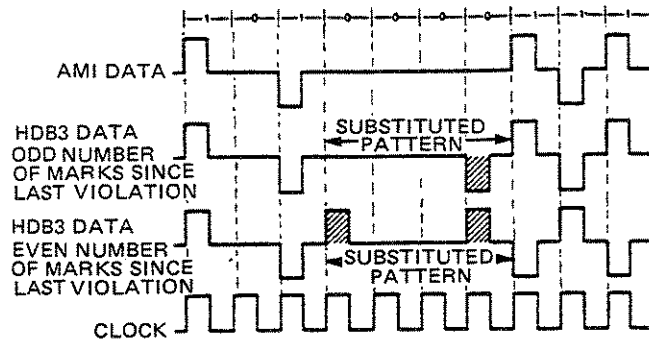

Figure B-2 HDB3 Data

HELP

: A set of screen messages which offer advice for the operator of an HP 3784A.

HIT SEC

: A second of real-time during which jitter hits occurred.

HP1

: A high pass filter with corner frequency corresponding to f_1 of the standard tolerance mask.

HP2

: As above for frequency f_2 .

HP1 + HP2

: A measurement of jitter using HP1 and HP2 simultaneously such that the complete tolerance mask shape is used as the hit threshold.

HT. FREE S.

: A second of real time during which no jitter hits occurred. (Hit Free Second)

Jitter

: Jitter, or to be more exact "Timing Jitter", is defined as short term variations of the significant instants of a digital signal from their ideal positions in time (see Figure B-3).

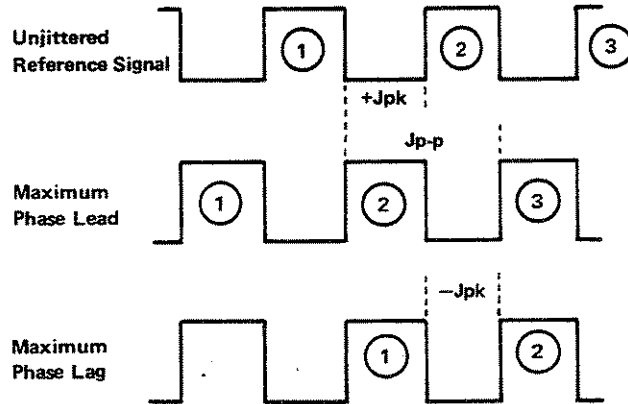

Note: The Maximum Phase Lead and Maximum Phase Lag diagrams show a jittered signal with a jitter amplitude of 1.0UI p-p.

Figure B-3 Jitter

Unit Intervals (UI)

: Jitter amplitude is measured in quantities of unit intervals. A unit interval is the time allocated for the transmission of one bit of information.

$$1 \text{ UI} = \frac{1}{\text{Symbol Rate}}$$

Therefore, for the 3784A bit rates, consult the following table.

Bit Rate (kHz)	1 UI (ns)
2048	488.28
8448	118.37
34368	29.09

Jitter Measurement (Peak-to-Peak)

: Jitter measurement p-p (J p-p) is a measurement of the maximum total excursion in the time position of a particular jittered bit relative to the time position of that particular bit when unjittered. (See Figure 1-3.)

Jitter Measurement (Positive or Negative Peak)

: Jitter measurement (+Jpk or -Jpk) is a measurement of the maximum excursion, either leading or lagging, in the time position of a particular jittered bit relative to its long-term mean position. (See Figure B-3.)

Internal Filtering - High Pass (HP) and Low Pass (LP)

The HP1/LP, HP2/LP and LP filters (which are used to pre-shape the demodulated jitter before measurement of jitter amplitude) are those specified as High Pass Filter No. 1 and High Pass Filter No. 2 in CCITT Recommendation 0.171 - two for each bit rate.

Internal Jitter Tolerance Masks	: The internal hard-programmed jitter tolerance masks, one for each internal clock rate, are the "Lower Limit of Maximum Tolerance Input Jitter" masks specified in CCITT Rec. G703.
Jitter Hit Threshold	: The jitter hit threshold is the peak jitter amplitude, both positive and negative, which the user defines to allow the instrument to analyze the received jitter in terms of jitter amplitude.
Jitter Hit	: A jitter hit is defined as an occurrence when the received jitter has exceeded the jitter hit threshold.
Jitter Hit Second	: A jitter hit second is defined as a second (in real time) which contains one or more jitter hits.
Jitter Hit-Free Second	: A jitter hit-free second is defined as a second (in real time) which contains zero jitter hits.
JITTER LOSS	: The condition when the HP 3784A has lost synchronisation of the jitter free reference used for jitter measurements.
Keyboard Lock	: Function for disabling all keys except PAGE and CURSOR POSITION keys.
Results	: The basic or primary measurement results performed by the HP 3784A.
Rx Setup	: The primary parameters required for setting up the receiver for basic measurements.
SAVE	: EXEC, function for recording current HP 3784A settings in a preset panel.
Self Test	: A series of internal functional tests which the HP 3784A can perform on its own circuitry and firmware.
SIGNAL LOSS	: The state where no signal transitions are seen at the Rx Data Input.
Squelch	: A mechanism for inhibiting logging from repeated triggers.
SYNC. LOSS	: The state where the locally generated reference pattern cannot be synchronised to the input data. (BIT errors only).
Trigger	: A device which initiates the logging of a result.
Tx Setup	: A set of parameters which control the HP 3784A transmitter. (Note: The transmitter pattern is linked to the pattern of the receiver.)
UIP	: Unit intervals peak. (Unit interval = Clock period).

Introduction

This section brings together important operating notes included in other sections.

Selecting Jitter Measurements

If you have an Option 002 instrument but are unable to select any Jitter measurements on Page 4, or can only select [OUTPUT JITTER], check the following:

- Option 002 is selected on Page 12 **Option/Self Test**.
- A standard clock frequency of 2, 8 or 34 MHz is selected on Page 2 **Tx Setup** or the external clock frequency is within $\pm 10\%$ of one of these standard rates.

Selecting Thrudata

Select Page 2 **Tx Setup** and set the **Pattern** field to [THRUDATA].

Note It is not possible to select [THRUDATA] if a [STD RATE] [704kHz] or [EXT] Clock is selected on Page 2 **Tx Setup**.

Selecting Codirectional Interface

When selecting the codirectional interface on Option 006 64 kbit/s Measurements, parameters on Page 2 **Tx Setup** should be set in the following order:

1. First set the **Clock** field to [STD RATE] [64kHz], before attempting to set the **Data Out** field.
2. Set the **Data Out** field to [CO-DIR] and [-OCT] or [+OCT].

Monitor Code Errors Alarm Led

When making measurements on coded ternary data, you have a choice of measuring either code errors or frequency offset in addition to bit errors. You must ensure that Rx [CODE ERR.] is selected on Page 4 [ERROR RESULTS] when you want to monitor the HP 3784A Code Error Alarm Led on the front panel, as this led and code error measurement are disabled when Rx[FREQUENCY OFFSET] is selected.

Measuring Received Jitter in Thrudata Mode

In Option 002 instruments, when in THRUDATA mode, the received jitter is measure on the RX CLOCK IN port independent of the 'thrudata' interfaces selected. Receiver Bit/Code measurements operate on the receiver signal as normal.

Interface Choices

When the transmitter clock is set to [STD RATE], the interface choices are restricted as described in the instrument specifications. If the transmitter clock is set to [VAR] or [EXT], the interface choices at the transmitter are free, although measurements at the receiver on ternary data are restricted to within ± 120 ppm or the standard rates.

Tx Jitter Amplitude p-p (option 002)

If the Transmitter Clock frequency is set to [VAR] or [EXT] with a bit rate $\pm 10\%$ of the STD rate, (2,8,34 MHz) the appropriate jitter modulator will automatically be selected to correspond with the bit rate. If the Transmitter Clock frequency is outwith $\pm 10\%$ of the STD rates then TX Jitter Amplitude p-p will be deselected on Page 4 Measurements.

In the case of [EXT] clock the measured Tx Clock frequency is checked for correct modulator selection every 3 seconds.

Optimum Jitter Intrinsic Performance

For optimum intrinsic jitter performance, the HP 3784A transmitter and receiver should either be used at identical bit rates, i.e. from the same clock source, or at rates differing by more than 10 %. i.e. $>10\%$ different.

Avoiding Timing Problems

When using the receiver in binary mode, it is important that the correct phase relationship between the clock and data signals is maintained at the receiver interface. Two methods can be used to ensure that they are in phase. The first is to alter the relative length off the two cables connecting the signals to the receiver inputs. The second is to invert the clock signal at either the transmitter or receiver by setting the Clock Out field on Page 2 Tx Setup or the Clock field on Page 3 Rx Setup respectively to [INV].

Selecting Jitter Masks

The selection of STD or PROG jitter masks in option 002 instruments can be made either on Page 1 Preset or Page 4 Measurements. The selected mask will be printed in dashed form on the automatic tolerance plot.

RX REF CLOCK IN

Using this input and Measurement Range 1 (on Page 4 RESULTS) it may be necessary to compensate for static phase offset between the reference clock and jittered clock. Incorrect phasing can be seen on the DEMOD JITTER O/P port as abrupt 1UI steps in phase.

Operator Selectable Switches In The HP 3784A

D

CAUTION

Note that for the operator to set the switches listed here necessitates removing protective covers. It is imperative therefore that the line cord be disconnected from the HP 3784A before attempting to remove these covers and set internal switches.

A. There is an 8 bit switch on the A11 Assembly, which when viewed from above looks as follows:

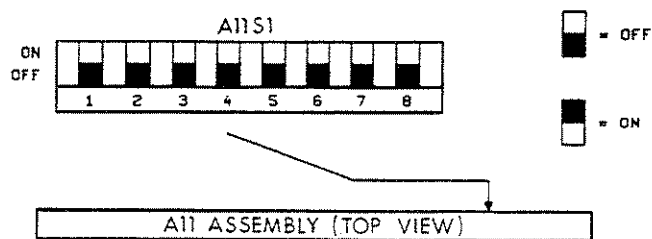

The function of these switches is as follows:

- SWITCH 1:-** Allows selection of DTR operation.
When OFF the DTR is forced high.
When ON the DTR polarity is made selectable (i.e. it appears as a field on Page 8 Remote Control).
- SWITCH 2:** This switch allows basic tests to be carried out. It switches the instrument into diagnostic mode. The switch must be OFF for normal operation.
- SWITCH 3:** This switch induces the instrument to execute all re-initialisation procedures on power-up, including;
- recalibration of synthesiser curve tables in RAM.
 - re-initialisation of all RAM based values.
 - resetting instrument (including real time clock) to initial default values. The switch must be OFF for normal operation.
- SWITCHES 4-6** These three switches define the instrument option as follows:
They must be placed in the correct setting for the correct hardware configuration.

Table D-1. Option Configuration

Switch Number	Instrument Option
6 5 4	
ON OFF ON	002 (BER plus Jitter at 2.8 and 34 MHz. BER only at 704kHz)
ON ON OFF	006 (BER only at 64kHz, 704kHz, 2MHz, 8MHz and 34MHz)

SWITCH 7: DEBUG and TEST ONLY. Switch must be OFF.

SWITCH 8: Kernal Diagnostics. Refer to Service Manual.
Must be OFF for normal operation.

Panel Memory Record Sheet

E

Introduction

Table E-1 is provided to allow users to keep a record of the measurement configurations stored in each Panel Memory.

Table E-1.

PRESET PANEL	MEASUREMENT
1.	
2.	
3.	
4.	
5.	

Introduction

The following information highlights the area most likely at fault when an error code is displayed. Detailed lists and explanations of error codes are given in the HP 3784A Service Manual (part number 03784-90002).

There are six separate selftests for the HP 3784A, all of which can be invoked by selecting the appropriate selftest and hitting the 'EXEC' key. All except three of the selftests will disable the operation of the instrument until the selftest is complete. These are the CPU, Modem port and Printer port selftests. The other tests require the instrument to be operating normally with all of its functions running. Here, the Jitter, Synthesiser and the BER/Interface selftests can be considered as background routines controlling the instruments settings and testing the results of various operations.

All of the selftests will run until either the test passes or the test fails. In the case of the Jitter, Synthesiser and BER tests a fail will result in the instrument settings being left as they were at the time of failure as a clue to the mode of failure, otherwise the settings will revoke to what they were just before selftest started.

CPU Selftest

This tests both the RAM and the ROM of the HP 3784A Processor card (A11).

RS-232 Modem Port Selftest

The special loopback connector (5060-4462) must be fitted in the RS232 MODEM port in order to run this test correctly. This test locks out all other instrument functions such as remote communications and keyboard functions, so it should not be disturbed for fifteen seconds.

RS-232 Printer Port Selftest

The special loopback connector (5060-4462) must be fitted in the RS232 PRINTER port in order to run this test correctly. This test locks out all other instrument functions such as remote communications and keyboard functions, so it should not be disturbed for fifteen seconds.

Clock Synthesiser Selftest

This program executes the procedures necessary to check the operation of the Clock Synthesiser. A cable must be connected between the TX CLOCK OUT AND RX CLOCK IN ports.

Jitter Selftest

This program checks the jitter measurement circuitry contained in option 002 instruments. At the start of the test it is assumed that both TX CLOCK OUT and RX CLOCK IN, and TX DATA OUT and RX TERNARY IN are connected back to back. An error will result if they are not. Note that it is also possible to connect only ternary data back to back and run the 'DATA IO' jitter subtest, (selected on Page 12 Self Test). Alternatively, connect just the Tx and Rx clock signals back to back and run either of the 'CLOCK IO', 'FREQ/HIT' or 'FILTERS' subtests.

During the test it is possible to change the instruments display page, remembering that keyboard lock is enabled to prevent unwanted parameter disturbance which would result in selftest failure. Thus it is possible to view the jitter results page as the test progresses.

BER Self Test

This program checks the HP 3784A BER and Interface circuitry. At the start of the test it is assumed that one of four interfaces is connected back to back. An error will result if it is not.

During the test, it is possible to change the displayed page of the instrument. Keyboard lock being enabled prevents unwanted parameter disturbance which would result in selftest failure. Thus it is possible to view the Transmitter or Receiver setup page as the test progresses.

Table of Error Codes

Table F-1. Synthesiser Error Codes

Error Codes	Reason
10	No transitions at binary clock input.
11	unable to obtain synthesiser lock.
20-29, 40-58	incorrect frequency generated.

Table F-2. Error Codes for Jitter Range Clock Test

Error Code	Clock Rate	Tx Amplitude (UI _{p-p})	Failed On
100	704kHz	0.00	Tx Amp.
100-103			Rx Amp.
104		3.00	Tx Amp.
105-107			Rx Amp.
108		6.00	Tx Amp.
109-111			Rx Amp.
112		9.00	Tx Amp.
113-115			Rx Amp.
120	2048kHz	0.00	Tx Amp.
121-123			Rx Amp.
124		3.00	Tx Amp.
125-127			Rx Amp.
128		6.00	Tx Amp.
129-131			Rx Amp.
132		9.00	Tx Amp.
133-135			Rx Amp.
140	8.448kHz	0.00	Tx Amp.
141-143			Rx Amp.
144		3.00	Tx Amp.
145-147			Rx Amp.
148		6.00	Tx Amp.
149-151			Rx Amp.
152		9.00	Tx Amp.
			Rx Amp.

Table F-2. Error Codes for Jitter Range Clock Test (continued)

153-155	8.448kHz	9.00	Rx Amp.
180	34.368MHz	0.00	Tx Amp
181-183			Rx Amp.
184		3.00	Tx Amp.
185-187			Rx Amp.
188		6.00	Tx Amp.
189-191			Rx Amp
192		9.00	Tx Amp.
193-195			Rx Amp.

Table F-3. Error Codes for Jitter Range Test Data

Error Code	Reason
200-214 220-225	All of the failures are due to incorrectly received pk-pk jitter amplitude.

Table F-4. Frequency Modulators/Hits Threshold Error Codes.

Error Codes	Reason
230-239	Internal Frequency Modulators incorrect.
240-245	Hit Threshold Detector faulty.

Table F-5. Error Codes for HP 3784A Jitter Filters

Error Codes	Reason
260-268 270-278 290-298	Fails 3db cut-of points of the instrument jitter filters.

Table F-6. Miscellaneous Jitter Error Codes

Error Code	Reason
269	No synth lock
279	No Receiver clock input signal.
289	No ternary data input signal.
299	Jitter sync not achieved.

Table F-7. Error Codes for Bit Error Add Test

Error Codes	Reason
350	no pattern sync when Rx word = Tx word
351	expected 10 single bit errors.
352	expected 0 code errors during bit error add.
353	bit errors alarm not received when rate 10E-3.
354	bit error ratio not 10E-3.
355	code error ratio not 0.
356	bit errors alarm not received when rate 10E-4
357	bit error ratio not 10E-4.
358	code error ratio not 0.
359	bit errors alarm not received when rate 10E-5.
360	bit error ratio not 10E-5.
361	code error ratio not 0.
362	bit errors alarm not received when rate 10E-6.
363	bit error ratio not 10E-6.
364	code error ratio not 0.

Table F-8. Error Codes for Code Error Add Sub-Test

Error Code	Reason
370	Tx=HDB3, Rx=AMI, Rx not detecting BPV's or Tx not HDB3.
371	Tx=AMI, Rx=HDB3. Rx detecting BPV's (should be none).
372	Tx=Rx=AMI. Errors detected when same coding.
373	expected 10 single code errors (AMI).
374	expected 0 bit errors during code error add (AMI).
375	code errors alarm not received when rate 10E-3.
376	code error ratio not 10E-3.
377	bit error ratio not 0 during code error add 10E-3.
378	code errors alarm not received when rate 10E-4
379	code error ratio not 10E-4.
380	bit error ratio not 0 during code error add 10E-4.
381	code errors alarm not received when rate 10E-5.
382	code error ratio not 10E-5.
383	bit error ratio not 0 during code error add 10E-5.
384	code errors alarm not received when rate 10E-6.
385	code error ratio not 10E-6.
386	bit error ratio not 0 during code error add 10E-6.
387	no code errors when Tx=Rx=HDB3 and code error rate 10E-3.
388	no code errors when Tx=Rx=HDB3 and code error rate 10E-4.
389	no code errors when Tx=Rx=HDB3 and code error rate 10E-5.
390	no code errors when TX=Rx=HDB3 and code error rate 10E-6.

Note: BPV's= Bipolar Violations.

Table F-9. Miscellaneous BER Error Codes

Error Code	Reason
399	no loopback signal present.

Table F-10. Error Codes for CPU Self Test

Error Code	Reason
400	RAM at address 0000H - 7FFFH fails R/W test.
410	ROM at address 0E0000H - 0FFFFFFH fails crc test.
411	ROM at address 0C0000H - 0DFFFFFFH fails crc test.
412	ROM at address 0A0000H - 0BFFFFFFH fails crc test.

Table F-11. Error Codes for RS-232 Modem Port Test

Error Code	Reason
500	Missing loopback connector or worse.
501	Fault suspected in DUART chip.
502	CTS line failed.
503	RTS line failed.
504	DTR line failed.
505	DSR line failed.
506	DCD line failed.
507	RI line failed.
508	Tx/Rx transmission errors

Table F-12. Error Codes for RS-232 Printer Port Test

Error Code	Reason
510	Missing loopback connector or worse.
511	CTS line failing, holding off transmissions.
512	Tx/Rx transmission errors.

A

- Additional measurements, 3-16
- AIS pattern generation and detection, 3-18
- AIS, 2-15, A-4
- Alarm Durations, 4-15
- Alarms, 2-15
- Alternating Word External Input Port., 2-13
- ALT WORD, 4-5
- AMI, B-1
- Analysis pass/fail thresholds, 3-14
- Applications of Data Logging, 5-1
- Audio Source, 4-15
- Auto Setup, 4-7
- Automatic Jitter Transfer Function Plotting, A-7
- Automatic Tolerance Plotting, A-6
- AUDIO key, 2-12
- AUTO JITTER TRANSFER FUNCTION, 4-11
- AUTO TOLERANCE PLOT, 4-11
- Availability, A-2
- Avoiding timing problems, C-2

B

- Battery Failure, 7-3
- Battery Replacement, 7-4
- BER Self Test, F-2
- Binary, 4-7
- Bit errors, 2-15
- Bounds Indicators, A-10

C

- CCITT, B-1
- Changing User Selectable Functions/Parameters, 2-10
- Clock Generation, 4-4
- Clock Out, 4-6
- Clock synthesizer selftest, F-1
- Clock, 4-5
- Code error injection and measurement, 3-8
- Code errors, 2-15
- Code Error Triggers, 5-20
- Configure an HP RS-232-C ThinkJet Printer, 5-3
- Configure an HP-IB ThinkJet Printer, 5-3
- Connecting the HP 3784A to a Printer, 5-2
- Connection to the RS-232-C system, 7-10
- Connection To The HP-IB, 7-8
- Contents, 7-1

Controlling the cursor, 2-9
Cumulative Slip Deciseconds, 4-15
Cursor position keys, 2-11

D

Data Log, 4-16
Data Loss, A-5
Default settings, 2-18
Default Settings, 4-27
Degraded Minutes, A-3
Description, 1-1
DEMOD JITTER OUT, 2-16
Display Backlight, 2-12
Display Contrast Adjustment, 7-3
DTR, 4-24
Duplex, 4-23

E

Enabling Self Test, 2-18
End of Period Results Summary Explained, 5-17
Enq/Ack, 4-23
Environment, 7-4
Error analysis example, 3-15
Error analysis measurements, 3-14
Error Add, 4-6
Error Analysis, A-2
Error Bursts, A-3
Error Count, A-1
Error Distribution, A-3
Error Field Choices, 5-17
Error Free Intervals, A-2
Error Intervals, A-1
Error Measurements, A-1
Error out, 8-37
Error Out Port, 4-29
Error Ratio, A-1
Error Seconds, A-3
ERROR ADD key, 2-12
ERROR ANALYSIS, 4-11
External Jitter Modulation Input Port (Option 002), 2-13
External modulation input (option 002), 8-42
External modulation, 3-24
External Triggering, 5-24
EXEC key, 2-12
EXT MOD/ALT WORD, 2-13

F

Finding the Index Page, 2-4
Frequency and Offset, A-6
Frequency offset measurements, 3-17
Front panel input/output ports, 2-13
Front panel operating features, 2-11
Fuses, 2-1, 7-2

G

Gating Period, 4-13, B-1
Gating type, 4-13
GO/NO GO Tests, A-4
Graphics Mode, 5-10
Graphics, 4-16

H

HDB3, B-2
Help, 4-10
HELP key, 2-12
Hit Count, A-9
Hit Free Intervals, A-9
Hit Intervals, A-9
Hits, 2-15, A-10
How to log measurement results, 5-25
HP 3784A display at switch-on, 2-3
HP 3784A Display, 2-12
HP 3784A jitter tolerance measurements, 3-29
HP 3784A opt 006 - 64 kbit/s measurements, 3-37
HP ThinkJet printer, 4-16
HP-IB Cables, 7-9
HP-IB Installation, 7-8
HP-IB Modes, 4-22
HP-IB verification, 8-41
HP3784A display contrast adjustment, 7-3

I

In-service output jitter measurements, 3-28
Instrument turn on, 2-1
Instrument Turn On, 2-1
Int Mod and Demod Jitter Measurement In (opt 002), 8-50
Interface choices, C-2
Internal Battery, 7-3
Internal Filtering, A-8, B-3
Internal Jitter Tolerance Masks, B-4
Interval Counts Explained, 5-15

Intrinsic jitter performance, 3-25
Introduction, 2-1

J

Jitter analysis measurement, 3-28
Jitter Display Rate, 4-9
Jitter Hit Threshold, B-4
Jitter Hit, B-4
Jitter loss, 2-15
Jitter measurement display update rates, 3-25
Jitter self test, F-2
Jitter Tolerance Standard and Programmable Masks, 4-2
Jitter Unlock, A-9
Jitter, 4-18, B-3
JITTER GENERATION, 3-22
JITTER MEASUREMENT, 3-25
JITTER MEASUREMENTS - OPTION 002, 3-20
JITTER TOLERANCE MEASUREMENT, 3-30
JITTER TOLERANCE, 4-12
JITTER TRANSFER FUNCTION, 4-12

K

Keyboard Lock, 4-2

L

Line Voltage Selection, 7-2
Liquid crystal display (L.C.D.), 2-12
Log Code Error Results Graphically, 5-13
Log on Demand, 5-22
Log results in a summary, 5-17
Log Results via HP-IB to Printer, 5-2
Log Results via RS-232-C to a Printer, 5-2
Log, 4-17
Logging Bit Error Measurement Results, 5-7
Logging Port, 4-28
Logging Trigger during Real Time, 5-20
Logging Trigger for End of Period Summary, 5-21
Long Term Mean Error Ratio, A-4
Loss Measurements, 3-2, A-4
LOCAL key, 2-11
LOG ON DEMAND key, 2-11
LOG ON DEMAND, 5-20

M

- Making a Bit Error Count Measurement, 2-6
- Making a measurement, 3-4
- Making in-service code error measurements, 3-12
- Making out-of-service error measurements, 3-7
- Making your first measurement, 2-3
- Measurement filters, 3-25
- Measurement gating, 8-36
- Measurement In, 4-29, A-9
- Measurements, A-1
- Measuring code errors on live traffic, 3-12
- Measuring received jitter in thru data mode, C-2
- MEASUREMENT IN, 2-17
- Modulation, 4-12
- Monitor code errors alarm led, C-1

N

- Need help?, 4-1

O

- Operating Environment, 7-4
- Operating The HP 3784A, 2-1, 2-3
- Optimum jitter intrinsic performance, C-2
- Option 002, A-6
- Option instruments, 2-18
- Output jitter measurement, 3-27
- OUTPUT JITTER, 4-12

P

- Page 4 Results explained, 5-16
- Panel Memory, 4-2
- Parity, 4-25
- Pattern, 4-5
- PAGE keys, 2-11
- PAGE Keys, 2-8
- PAGE 4 Results, 5-16
- Performing jitter self tests (option 002), 8-55
- Plotted Results, 5-10
- Power Cable, 7-2
- Power loss, 2-15
- Power Loss, A-4
- Power Requirements, 7-2
- Powering Up, 2-3
- POWER key, 2-11
- Practical jitter measurements, 3-20
- Practical measurements at 64 kbit/s codirectional interfaces, 3-38

Preset Panel, 4-1
Programmable Tolerance Masks, 4-3, A-8
PRBS, 4-5

R

Rack Mounting, 7-4
Rear panel input/output ports, 2-16
Rear Panel Ports, 4-29
Receiver autoconfigure, 8-34
Receiver clock recovery, 8-26
Receiver Clock rate, 4-8
Receiver Display Rates, A-8
Receiver Pattern, 4-8
Receiver reference PRBS patterns and zero substitution, 8-31
Recommended Printers, 5-1
Reference word and synchronization, 8-30
Result Formats, 4-10
Results logged for Manual/Single gating periods, 5-15
Results logged for Repeat gating period, 5-15
Results printed in Real Time, 5-15
REAL TIME, 4-17
RS-232 modem port selftest, F-1
RS-232 printer port selftest, F-1
RS-232-C Interface Installation, 7-9, 7-10
RS-232-C Remote Control, 7-10
RS232 Modem port, 4-22
RS232 (Asynchronous), 4-22
Rx Clock Loss, A-5
Rx Reference Clock, 4-30
RX BIN DATA IN, 2-15
RX CLOCK IN, 2-15
RX ERROR OUT, 2-17
RX REF CLOCK IN/OUT (Option 002), 2-17
RX TERNARY DATA IN, 2-15

S

Safety Considerations, 6-1
Selectable Port, 4-30
Selecting an index or page, 2-8
Selecting codirectional interface, C-1
Selecting jitter masks, C-2
Selecting jitter measurements, C-1
Selecting thrudata, C-1
Self test features, 2-18
Self test, 4-32
Set-up Field, 4-16
Setting Instrument Default State, 2-4
Severely Errored Seconds, A-3
SELECTABLE PORT, 2-16

Index-6

Slip Count, A-5
Specifications, 6-1
SPOT MASK, 4-2
Squelch, 4-17, 5-23
Standard Tolerance Mask, 4-2
Standard Tolerance Masks, A-7
Status, 4-26
Storing measurement configuration, 3-5
START/STOP key, 2-12
STOP, 2-11
Subpage [SETUP B], 4-24
SUMMARY, 4-20
Summary, 5-17
SWEPT MASK, 4-2
Sync loss, 2-15
Sync Loss, A-5
Synth loss, 2-15

T

Table of error codes, F-2
Ternary data input levels, 8-28
Ternary data outputs, 8-18
Ternary, 4-8
Thrudata (option 002), 8-57
THRUDATA, 4-6
To recall set-up from panel memory, 3-19
To store configuration in preset panel, 3-19
To Select A Page, 2-8
To Select An Index, 2-8
Transmitter alternating word, 8-16
Transmitter Interface, 4-4
Transmitter jitter modulation, 3-23
Transmitter n-bit programmable word, 8-10
Transmitter pattern trigger, 8-12
Transmitter prbs pattern verification, 8-14
Trigger, 4-19, 4-21
Tx Clock Loss, A-5
Tx Data Output Amplitude, 2-14
Tx Jitter Amplitude p-p, C-2
TX CLOCK IN, 2-14
TX CLOCK OUT, 2-14
TX DATA OUT, 2-14
TX REF CLOCK OUT, 2-16

U

Unavailability, A-2
Unbalanced 75 ohms, 2-14
Unit Intervals, B-3
Update keys, 2-10

UPDATE keys, 2-12
Using zero substitution, 3-16

W

Warning/Indicator Lamps, A-9
What Stops Logging?, 5-23
What Triggers Logging?, 5-20
Word, 4-5

X

Xon/Xoff, 4-23

Z

Zero Sub, 4-5

Hewlett-Packard Sales and Service Offices

US FIELD OPERATIONS HEADQUARTERS

Hewlett-Packard Company
19320 Pruneridge Avenue
Cupertino, CA 95014, USA
(800) 752-0900

California

Hewlett-Packard Co.
1421 South Manhattan Ave.
Fullerton, CA 92631
(714) 999-6700

Hewlett-Packard Co.
301 E. Evelyn
Mountain View, CA 94041
(415) 694-2000

Colorado

Hewlett-Packard Co.
24 Inverness Place, East
Englewood, CO 80112
(303) 649-5000

Georgia

Hewlett-Packard Co.
2000 South Park Place
Atlanta, GA 30339
(404) 955-1500

Illinois

Hewlett-Packard Co.
5201 Tollveiw Drive
Rolling Meadows, IL 60008
(708) 255-9800

New Jersey

Hewlett-Packard Co.
120 W. Century Road
Paramus, NJ 07653
(201) 599-5000

Texas

Hewlett-Packard Co.
930 E. Campbell Rd.
Richardson, TX 75081
(214) 231-6101

EUROPEAN OPERATIONS HEADQUARTERS

Hewlett-Packard S.A.
150, Route du Nant-d'Avril
1217 Meyrin 2\Geneva
Switzerland
(41 22) 780.811

France

Hewlett-Packard France
1 Avenue Du Canada
Zone D'Activite De Courtaboeuf
F-91947 Les Ulis Cedex
France
(33 1) 69 82 60 60

Germany

Hewlett-Packard GmbH
Berner Strasse 117
60000 Frankfurt 56
West Germany
(49 69) 500006-0

Great Britain

Hewlett-Packard Ltd.
Eskdale Road,
Widdersh Triangle
Wokingham,
Berkshire RG11 5DZ
England
(44 734) 696622

INTERCON OPERATIONS HEADQUARTERS

Hewlett-Packard Company
3495 Deer Creek Rd.
Palo Alto, California 94304-1316
(415) 857-5027

Australia

Hewlett-Packard Australia Ltd.
31-41 Joseph Street
Blackburn, Victoria 3130
(61 3) 895-2895

Canada

Hewlett-Packard (Canada) Ltd.
17500 South Service Road
Trans-Canada Highway
Kirkland, Quebec H9J 2X8
Canada
(514) 697-4232

Japan

Yokogawa-Hewlett-Packard Ltd.
1-27-15 Yabe, Sagamihara
Kanagawa 229, Japan
(81 427) 59-1311

China

China Hewlett-Packard, Co.
38 Bei San Huan X1 Road
Shuang Yu Shu
Hai Dian District
Beijing, China
(86 1) 256-6888

Singapore

Hewlett-Packard Singapore
Pte. Ltd.
1150 Depot Road
Singapore 0410
(65) 273 7388

Taiwan

Hewlett-Packard Taiwan
8th Floor, H-P Building
337 Fu Hsing North Road
Taipie, Taiwan
(886 2) 712-0404



03784-90000

Printed in U.K.

MANUAL IDENTIFICATION

Model Number: HP 3784A
Date Printed: April 1989
Part Number: 03784-90000

Operating and Calibration Manual

MANUAL CHANGE IDENTIFICATION

Part Number: 03784-90010



This supplement contains important information for correcting manual errors and for adapting the manual to instruments containing improvements made after the printing of the manual.

To use this supplement:

Make all ERRATA corrections.

Make all appropriate serial number related changes indicated in the tables below.

Serial Prefix or Number	Make Manual Changes	Serial Prefix or Number	Make Manual Changes
2902U	No Change		
2918U	No Change		
3117U	1*		

* NEW ITEM

NOTE

Manual change supplements are revised as often as necessary to keep manuals as current and accurate as possible. Hewlett-Packard recommends that you periodically request the latest edition of the supplement. Free copies are available from all HP offices. When requesting copies quote the manual identification information from your supplement or the model number and print date from the title page of the manual.

20 Aug 1992

Page 1 of 8



ERRATA

Page 3-35, Making Measurements:

Add the following note to the "Automatic Transfer Function Measurement" procedure:

Note: To achieve the desired accuracy, the warm-up time specified should be allowed, i.e. 30 minutes at 25 degrees C.

Pages 3-38, 3-39, 3-40 and 3-41, Making Measurements:

Delete: "Jitter Display Rate [FAST]" on Page 3 Rx Setup display.

Page 6-8, General Information:

Add to the following:

Warmup Time.

All instruments: 30 minutes at 25 degrees C to operate within specified accuracy.

Page 7-2, Installation:

Amend Table 7-1 to state the fuse rating of HP part number 2110-0304 is 1.5A not 5A.

*Page 8-7, Performance Tests:

Amend the Frequency Offset Upper limit of -5ppm from 34 368 070 to 34 368 274

Page 8-9, Performance Tests:

Delete the reference to the "blocking capacitor" in step 6. Amend step 7 to read:

7. Set the HP 3784A to Data Out [BINARY] [ECL] and check that the signal levels from V_L to V_H are typically 1V pk to pk.

Page 8-9, Performance Tests:

Note: The clock signal shown in Figure 8-3 should be inverted, with the rising edge of the clock signal in the middle of the data marks.

*Page 8-36, Performance Tests:

Add the following steps to the procedure:

9. Select Page 5 Gating Period, Gating type [MANUAL] and press the START/STOP key.
10. Cycle power to the 3784A and verify that on power up the instrument is in gating mode and the POWER LOSS led is on.
11. Press the START/STOP key to stop the instrument gating.
12. Press the START/STOP key to restart the instrument gating and check that the POWER LOSS led goes off.
13. Press the START/STOP once more to stop the instrument gating.

*Page 8-70, Performance Tests:

Add the following step to section 4.24:

12. POWER LOSS led operates correctly.

*CHANGE 1

This change documents some added features to the standard HP 3784A and also the introduction of the V.11 interface in option 006 instruments.

Page 3-22, Making Measurements with the HP 3784A:

Add the following note to the description of THRUDATA mode.

The [THRUDATA] selection can be set for normal input or for de-jitterised input.

If the incoming signal is jitter free then the THRUDATA mode should be set to normal. If the incoming signal contains jitter then de-jitterised THRUDATA operation should be selected. This will remove any jitter in the incoming data/clock to ensure that any jitter added by the HP 3784A is at the correct level. When de-jitterised operation is selected the Tx Setup page will indicate that the rear panel RX REF CLOCK OUT port should be connected to the front panel TX CLOCK IN port.

Page 3-42, Making Measurements with the HP 3784A:

Add page 3-43/3-44, contained at the end of this Manual Change, to the end of Section 3.

Page 4-4, Page Function Description:

Alter the information in the sub-section titled **Option 006** to contain the following additional information.

Option 006

[CO-DIR][+OCT]	For the 64 kBit/s rate the choice of data interfaces are Binary (ECL/TTL), Co-directional or V.11.
[CO-DIR][-OCT]	
[V.11][DCE]	The V.11 interface has two possible modes of operation i.e. DCE or DTE. It also has a number of clock selections, refer to the sub-section titled Clock Generation .
[V.11][DTE]	

Page 4-5, Page Function Description:

Alter the information in the sub-section titled **Option 006**. Delete the reference to [STD RATE] [64kHz] and add the following information.

Option 006

[DATA RATE][64K]	Option 006 instruments have a choice of data rates which is dependent on the interface selected. When the Data Out field is set to [CO-DIR] the [DATA RATE] is limited to [64K]. If the Data Out field is set to [V.11] there are two methods for determining the data rate. When [V.11][DCE] is selected the rate is set internally and the following rates are available:- 600, 1200, 2400, 4800, 9600, 14.4K, 19.2K, 48K, 56K, 64K, 348K and 1984K. When [V.11][DTE] is selected the data rate is determined by an external clock signal.
------------------	--

Page 4-6, Page Function Description:

Add the following additional note to the [THRUDATA] field description.

[THRUDATA]

There are two modes of operation i.e. normal and de-jitterised.

Normal mode is used when the incoming signal is jitter free.

De-jitterised mode is used when the incoming signal contains jitter. When this mode is selected the HP 3784A will remove any jitter on the incoming signal to ensure that any jitter added by the HP 3784A is at the correct level. The Tx Setup page will indicate that the rear panel RX REF CLOCK OUT port should be connected to the front panel TX CLOCK IN port.

Page 4-7, Page Function Description:

Add the following additional information to the sub-section titled Data In.

Option 006

[CO-DIR]

[V.11][DCE]

[V.11][DTE]

Option 006 instruments have a choice of interfaces. The Data In field can be set for Co-directional or V.11 operation.

Page 4-9, Page Function Description:

Add the following information.

Sync

[MAN]

[AUTO]

A choice of patten synchronization is provided when Rx Setup [MAN] is set. Manual synchronization is initiated by pressing the front panel EXEC key.

Page 6-3, General Information:

Amend the Internal Variable Clock specification as follows:-

Range: 600Hz to 50MHz

Amend the External Clock Input specification as follows:-

Range: 75Hz to 50MHz

Page 6-14, General Information:

Add the following details concerning the V.11 interface.

General

Leased (point to point) operation as specified by X.21.

All X.21 circuits implemented (with the exception of byte timing (b)) and conform electrically to V.11 (X.27, RS-422-A).

15 pin D-type subminiature connector via adapter block plugged into the V.11 interface.

Data Rates

Fixed rates: 600b/s, 1.2, 2.4, 4.8, 9.6, 14.4, 19.2, 48, 56, 64, 384 and 1984kb/s.

Variable Rates: 600b/s to 2048kb/s.

External Clock Rates: 75b/s to 2048kb/s.

Driver and Receiver

Conforms to CCITT Recommendation V.11 (X.27, RS-422-A).

Pin Assignment

As in ISO 4903-1980.

The following interface circuits are implemented as shown in Table 1:

Pin	Circuit Name	
1	Shield	
2	Transmit (A)	T(A)
3	Control (A)	C(A)
4	Receive (A)	R(A)
5	Indication (A)	I(A)
6	Signal Element Timing (A)	S(A)
8	Signal Ground	G
9	Transmit (B)	T(B)
10	Control (B)	C(B)
11	Receive (B)	R(B)
12	Indication (B)	I(B)
13	Signal Element Timing (B)	S(B)

In X.21 leased mode, circuit C (pins 3 and 10) is held on and circuit I (pins 5 and 12) are ignored.

Page 7-10, Installation:

Add page 7-11, as contained at the end of this Manual Change, to the end of Section 7.

HP 3784A OPT 006 - V.11 Operation

Connecting and configuring the HP 3784A for V.11 operation

The HP 3784A can test the V.11 interface of Data Communications Equipment (DCE) or Data Terminal Equipment (LTE).

Testing DCE with the HP 3784A.

When testing DCE the 3784A acts as DTE. The configuration for testing DCE is as follows:-

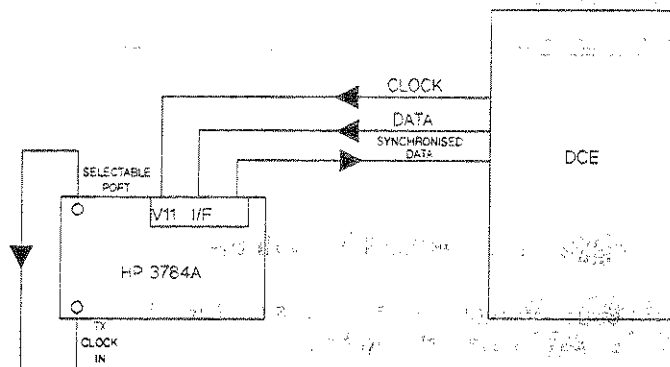

Figure 3-14 Testing DCE with the HP 3784A

1. Display page 2, **Tx Setup:** should be selected on the HP 3784A and the **Data Out:** field should be set [V.11][DTE]. The clock field should be set to [EXT].
2. The DCE under test clock signal is connected to the Signal Element Timing A/B pins on the V.11 interface connector, pins 6 and 13.
3. The data signal from the DCE under test is connected to the Receive A/B pins on the V.11 interface connector, pins 4 and 11.
4. The 3784A internally routes this DCE clock signal to the rear panel SELECTABLE port. This should be connected to the front panel TX CLOCK IN port to provide the clock signal for the transmitted data from the 3784A.
5. The re-synchronised transmitted data signal is available at the Transmit A/B pins on the V.11 connector, pins 2 and 9. This should be routed back to the DCE under test.

Testing DTE with the HP 3784A

When testing DTE the 3784A acts as DCE. The configuration for testing DTE is as follows-

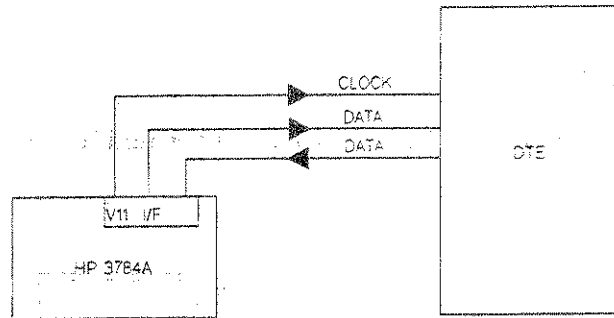

Figure 3-15 Testing DTE with the HP 3784A

1. Display page 2 Tx Setup: should be selected and the Data Out: field should be set to [V.11][DCE]. The [DATA RATE] field should be set to the preferred value.
2. The 3784A supplies the test clock and data via the Transmit A/B and Signal Element Timing A/B pins on the V.11 connector, pins 6,13 and pins 2,9 respectively. These pins should be connected to the DTE under test.
3. The data returned by the DTE is input to the 3784A at the Receive A/B pins on the V.11 connector, pins 4 and 11.

Note: Refer to Section 7 for pin-out information on the V.11 connector.

V.11 Interface Installation

The HP 3784A option 006 includes a V.11 interface for testing the electrical interfaces of datacomms equipment. The HP 3784A V.11 interface can be configured to the Data Communications Equipment (DCE) or Data Terminal Equipment (DTE).

Connection to the V.11 interface

The V.11 connector on the rear panel of the HP 3784A provides the physical interface to connect the HP 3784A to the datacomms interface under test. Figure 7-6 illustrates the connector pin configuration.

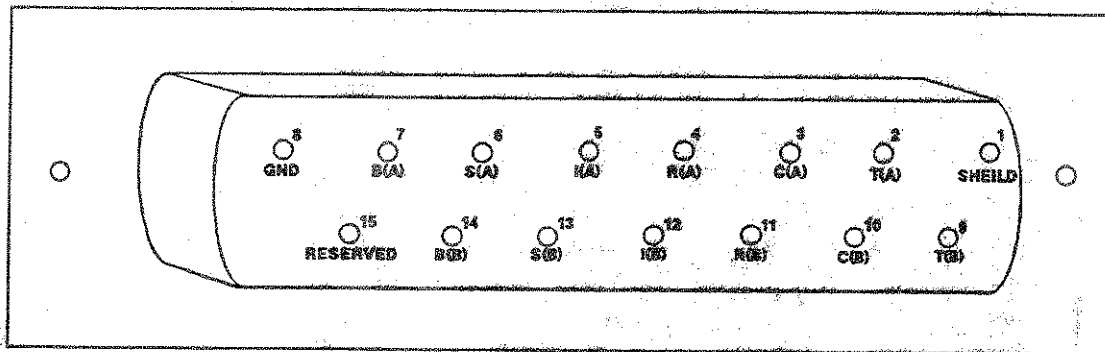

Figure 7-6 V.11 Interface Connector

T(A) = Transmit A
 T(B) = Transmit B
 R(A) = Receive A
 R(B) = Receive B
 C(A) = Control A
 C(B) = Control B

S(A) = Signal element timing A
 S(B) = Signal element timing B
 I(A) = Indication A
 I(B) = Indication B
 B(A) = Byte timing A
 B(B) = Byte timing B